



**TRENDNET**®



User's Guide

**TV-IP422**  
**TV-IP422W**  
H/W: A1.0R

# PREFACE

---

The Day/Night Pan/Tilt Internet Camera Server with Audio (TV-IP422/TV-IP422W) provides day and night security over a large area. See, hear and talk to people in your camera's viewing field day or night from any Internet connection. Secure a larger area with pan and tilt Internet cameras. Pan the camera side-to-side a remarkable 330° and tilt up-and-down 105°.

The TV-IP422W provides high quality video streams over a secure wireless connection. Advanced intuitive software includes motion detection recording, email alerts and scheduled recordings. This camera's brilliant image quality, pan/tilt functionality, day/night recording capabilities and built-in 2-way audio make it ideal for home, small office and business use.

- Chapter 1 Introduction to Your Camera** describes the features of the camera. You will also know the components and functions of the camera.
- Chapter 2 Hardware Installation** helps you install the camera according to your application environment. You can use this camera at home, at work, at any where you want.
- Chapter 3 Accessing the Camera** lets you start using your camera without problem. The camera can be set up easily and work within your network environment instantly.
- Chapter 4 Configuring the Camera** guides you through the configuration of the camera using the Web browser on your PC.
- Chapter 5 SecurView Softwae** using the convenience software to monitor your camera
- Chapter 6 Appendix** provides the specification of the camera and some useful information for using your camera.

**NOTE** The illustrations and configuration values in this guide are for reference only. The actual settings depend on your practical application of the camera.

# Contents

PREFACE .....	1
CHAPTER 1 .....	4
INTRODUCTION .....	4
1.1 PACKAGE CONTENTS .....	4
1.2 GETTING TO KNOW YOUR CAMERA.....	5
1.3 FEATURES AND BENEFITS.....	7
1.4 SYSTEM REQUIREMENT .....	9
CHAPTER 2 .....	10
HARDWARE INSTALLATION.....	10
2.1 INSTALLING THE WALL MOUNT KIT.....	10
2.2 CONNECTING THE CAMERA TO LAN/WLAN.....	11
2.3 APPLICATIONS OF THE CAMERA.....	12
CHAPTER 3 .....	13
ACCESSING THE CAMERA .....	13
3.1 USING IPSETUP .....	13
3.2 ACCESSING TO THE CAMERA .....	18
3.3 CONFIGURING THE IP ADDRESS OF THE PC .....	23
CHAPTER 4 .....	24
CONFIGURING THE CAMERA.....	24
4.1 USING THE WEB CONFIGURATION.....	24
4.2 USING SMART WIZARD .....	25
4.3 BASIC SETUP .....	29
4.4 NETWORK SETTINGS .....	33
4.5 PAN/TILT SETTINGS.....	39
4.6 SETTING UP VIDEO & AUDIO.....	41
4.7 EVENT SERVER CONFIGURATION.....	46
4.8 MOTION DETECT.....	50

4.9	EVENT CONFIG .....	51
4.10	TOOLS.....	57
4.11	USB.....	59
4.12	INFORMATION .....	60
CHAPTER 5	.....	61
SECURVIEW™ SOFTWARE	.....	61
5.1	INSTALLATION.....	61
5.2	USING INSTALLATION .....	66
ITEM FEATURES	.....	67
TO ADD A CAMERA	.....	74
TO REMOVE A CAMERA	.....	77
TO LINK TO THE WEB PAGE OF THE CAMERA.....		78
TO RECORD VIDEO .....		79
TO CONFIGURE THE RECORDING SETTINGS .....		84
TO PLAYBACK THE RECORDED VIDEO .....		86
TO SET UP MOTION DETECTION OPTIONS .....		87
ACCOUNT .....		89
OTHER.....		89
INFORMATION .....		90
APPENDIX.....		92
A.1	SPECIFICATION .....	92
A.2	GPIO TERMINAL APPLICATION.....	94
A.3	GLOSSARY OF TERMS.....	95

---

# CHAPTER 1

---

## INTRODUCTION

### 1.1 Package Contents

The package includes the following:

- TV-IP422 or TV-IP422W Camera
- Utility CD-ROM
- Multi-Language Quick Installation Guide
- External Antenna (for TV-IP422W only)
- GPIO Adapter
- RJ-45 Cable
- 12V 1.5A Power Adapter (3.5mm)
- Wall Mount Kit

**NOTE:** If there is item missing, please contact your local authorized dealer.



## 1.2 Getting to Know Your Camera

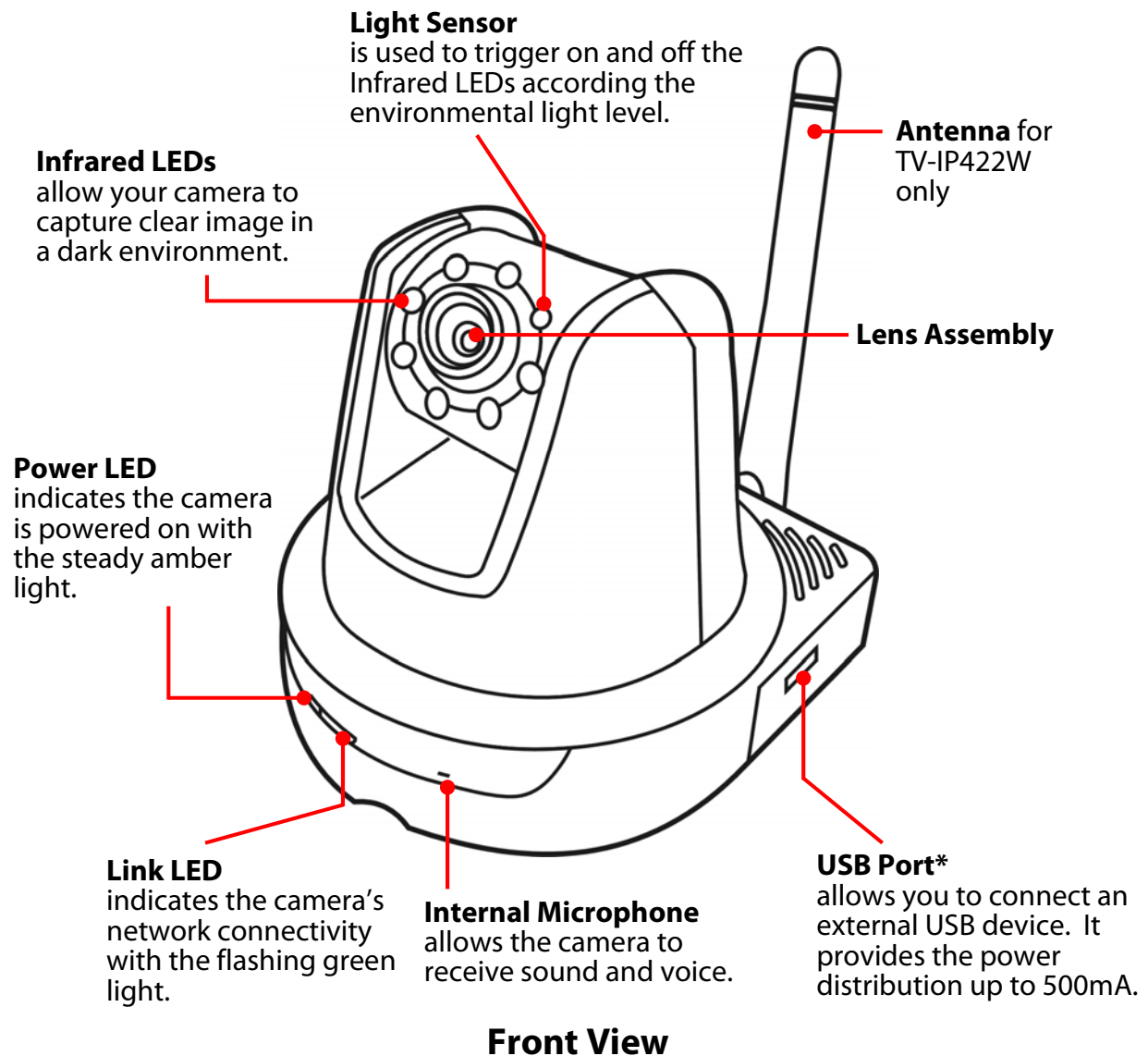

\* The camera's USB port supports WCN (Windows Connect Now) technology, which allows you to use the notebook computer to set up and store your wireless networking configuration on the USB storage device, and then retrieve the wireless settings when you connect the USB storage device to the camera.

**NOTE** After long pressing the Unmount button for four seconds, the Power LED starts flashing. When the Power LED resumes the steady amber light, you can remove the USB device safely.

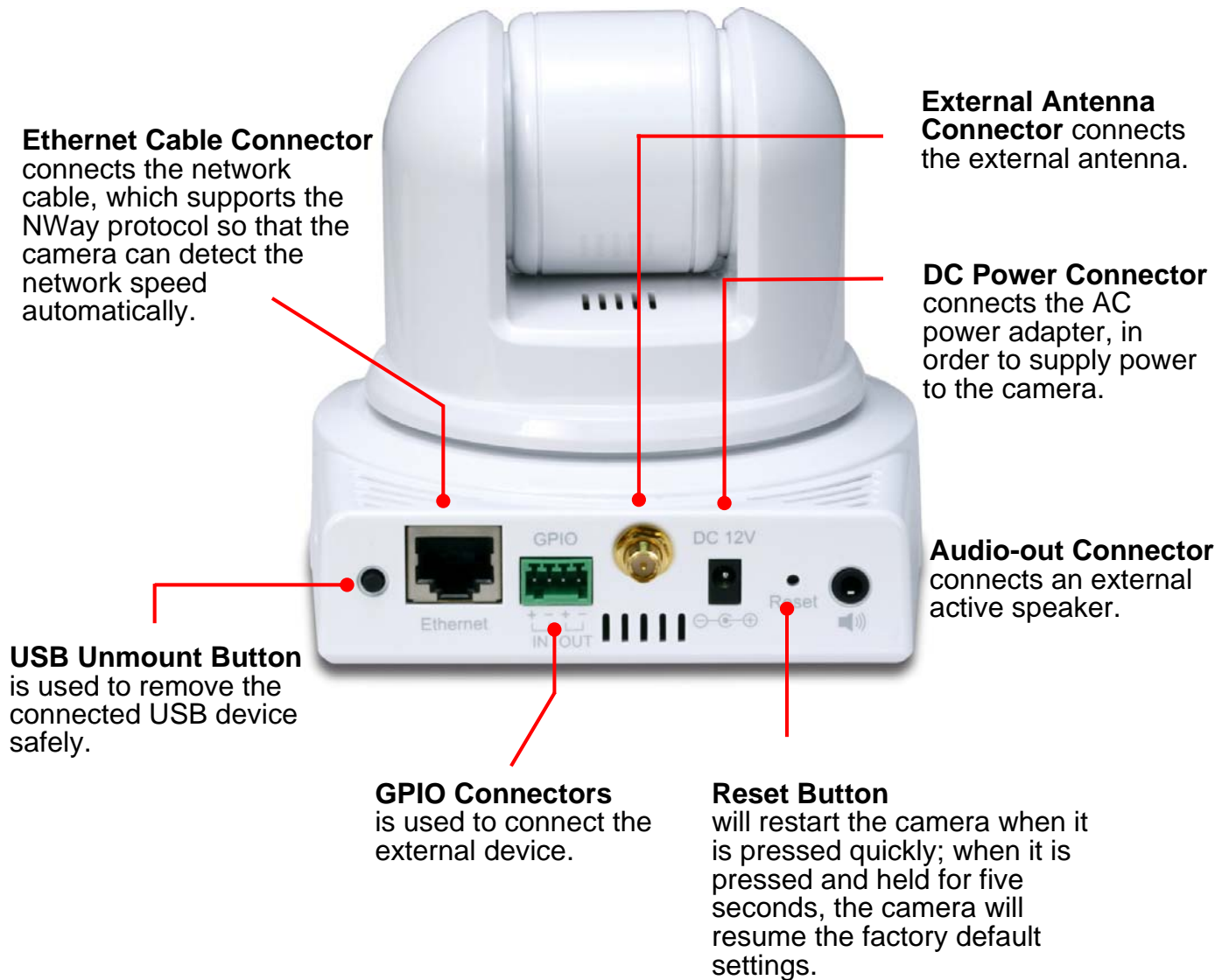

### Rear View

## 1.3 Features and Benefits

### ■ MPEG4/MJPEG Dual-codec Supported

The camera provides you with excellent images by the MPEG4/ MJPEG dual-codec selectable technology, allowing you to adjust image size and quality, and bit rate according to the networking environment.

### ■ 2-way Audio Capability

The built-in microphone of the camera provides on-the-spot audio via the Internet, allowing you to monitor the on-site voice. In addition, you can connect an external speaker to the camera to speak through the camera.

### ■ Day & Night Surveillance Supported

The seven Infrared LEDs around the standard lens assembly enable the camera to capture crystal clear images in the dark environment or at night. When the Light Sensor detects the environmental light level becomes low, the camera captures the images in black & white mode using these infrared LEDs.

### ■ Optimal Viewing

With the pan/tilt functions, you can easily monitor everywhere via the camera by moving the camera lens to the left/right (165/165 degrees) or up/down (90/15 degrees). In addition, you can assign up to eight positions for the camera, enabling you to move the camera lens to the desired position quickly.

### ■ Supports RTSP

The camera supports RTSP (Real Time Streaming Protocol), which is a technology that allows you to view streaming media via the network. You can view the real-time video with the Quick Time player or RealPlayer. To view the real-time streaming image on your computer, open the Web browser and enter the RTSP link: [rtsp://\(IP address of the camera\)/mpeg4](rtsp://(IP address of the camera)/mpeg4).



## ■ **Supports Multiple Profiles**

The camera supports multiple profiles simultaneously, so that you can separately set up different image settings (such as image quality and frame rate) for the three video types of the camera: MPEG4, MJPEG, and 3GPP.

## ■ **I/O Connectors Provided**

The camera provides the I/O connectors on the rear panel (IN/OUT), which provide the physical interface to send and receive digital signals to a variety of external alarm devices. You can connect a special featured device, and then configure the settings and control the device from the **GPIO Trigger** window of Web Configuration.

## ■ **Remote Control Supported**

By using a standard Web browser or the bundled SecurView software application, the administrator can easily change the configuration of the camera via Intranet or Internet. In addition, the camera can be upgraded remotely when a new firmware is available. The users are also allowed to monitor the image and take snapshots via the network.

## ■ **Supports Connection to the External Devices**

With the auxiliary Input/output connectors, you can connect the camera to a variety of external devices, such as the external speaker and the USB device.

## ■ **Multiple Platforms Supported**

The camera supports multiple network protocols, including TCP/IP, SMTP e-mail, HTTP, and other Internet related protocols. Therefore, you can use the camera in a mixed operating system environment, such as Windows 2000 and Windows XP and Windows Vista.

## ■ **Multiple Applications Supported**

Through the remote access technology, you can use the cameras to monitor various objects and places for your own purposes.

For example, babies at home, patients in the hospital, offices and banks, and more. The camera can capture both still images and video clips, so that you can keep the archives and restore them at any time.

## 1.4 System Requirement

### ■ Networking

LAN: 10Base-T Ethernet or 100Base-TX Fast Ethernet.

WLAN: IEEE 802.11b/g.

### ■ Accessing the Camera using Web Browser

Platform: Microsoft® Windows® 2000/XP/Vista

CPU: Intel Pentium III 800MHz or above

RAM: 512MB

Resolution: 800x600 or above

User Interface: Microsoft® Internet Explorer 6.0 or above

Apple Safari 2 or above

Mozilla Firefox 2.00 or above

### ■ Accessing the Camera using SecurView®

Platform: Microsoft® Windows® 2000/XP/Vista

Hardware Requirement:

1 camera connected: Intel Pentium III 800MHz; 512MB RAM

2 ~ 4 cameras connected: Intel Pentium 4 1.3GHz; 512MB RAM

5 ~ 8 cameras connected: Intel Pentium 4 2.4GHz; 1GB RAM

9 ~ 16 cameras connected: Intel Pentium 4 3.4GHz; 2GB RAM

Resolution: 1024x768 or above

**NOTE:** Monitoring multiple cameras may require a high performance CPU.

# CHAPTER 2

---

## HARDWARE INSTALLATION

### 2.1 Installing the Wall Mount Kit

The camera comes with a Wall Mount Kit, which allows you to place your camera anywhere by mounting the camera through the three screw holes located in the base of the Wall Mount Kit.



## 2.2 Connecting the Camera to LAN/WLAN

Use the provided Ethernet cable to connect the camera to your local area network (LAN).

When you connect the AC power adapter, the camera is powered on automatically. You can verify the power status from the Power LED on the front panel of the camera.

Once connected, the Link LED starts flashing green light and the camera is on standby and ready for use now.



Connecting the Ethernet Cable

If you use a wireless network in your application environment, you need to attach the included external antenna to the camera.

When the camera is powered on, the camera will automatically search any access point with “default” SSID.



Connecting the External Antenna

**NOTE** If the camera cannot to your wireless network, you need to install the camera in LAN and proceed with WLAN settings.

## 2.3 Applications of the Camera

The camera can be applied in multiple applications, including:

- Monitor local and remote places and objects via Internet or Intranet.
- Capture still images and video clips remotely.
- Upload images or send email messages with the still images attached.

The following diagram explains one of the typical applications for your camera and provides a basic example for installing the camera.

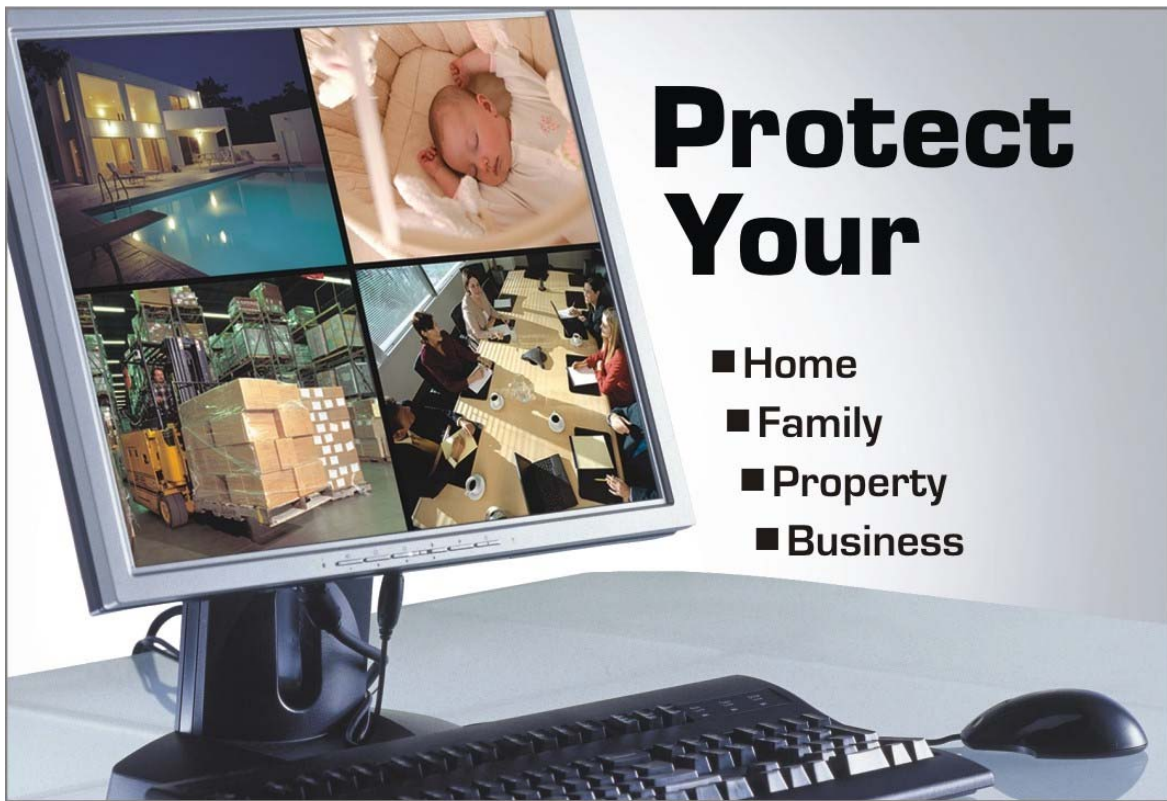

### Applications

# CHAPTER 3

---

## ACCESSING THE CAMERA

### 3.1 Using IPSetup

The camera comes with a conveniently utility, IPSetup, which is included in the Installation CD-ROM, allowing you to search the camera on your network easily.

1. Insert the Installation CD-ROM into your computer's CD-ROM drive to initiate the Auto-Run program.



2. Click the **IP Setup** from the Auto-Run menu screen. Then IP Setup Wizard will appear. Click "**Next**" when the **Welcome to the IPSetup Setup Wizard** appears.





3. Click "**Browse**" to choose the desired destination location. By default, the destination location is C:\Program Files\TRENDnet\IPSetup. Then Click "**Next**".



4. Click "**Next**" to confirm the IPSetup software to be installed to the computer.

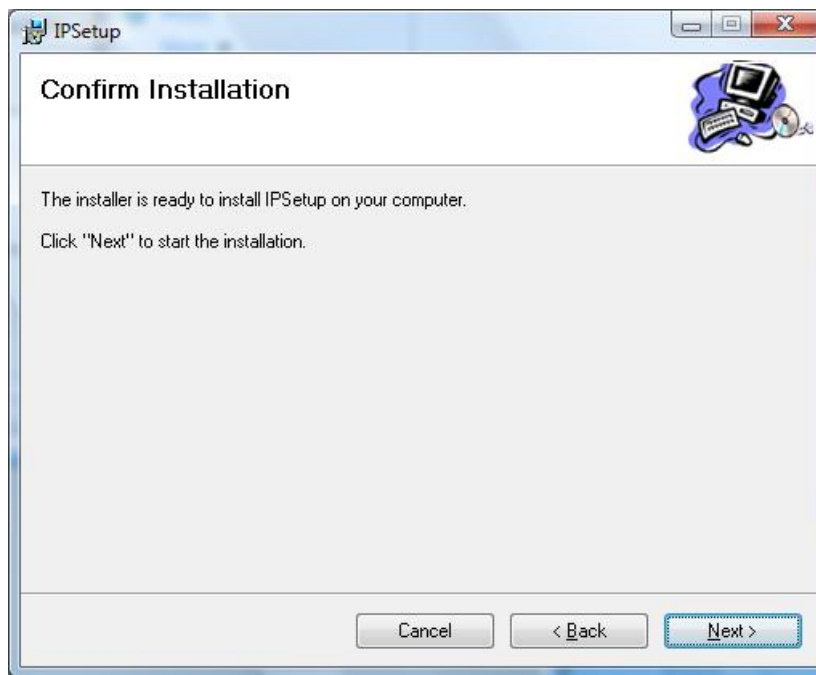

5. When the **Installation Complete** window appears, click "**Finish**".

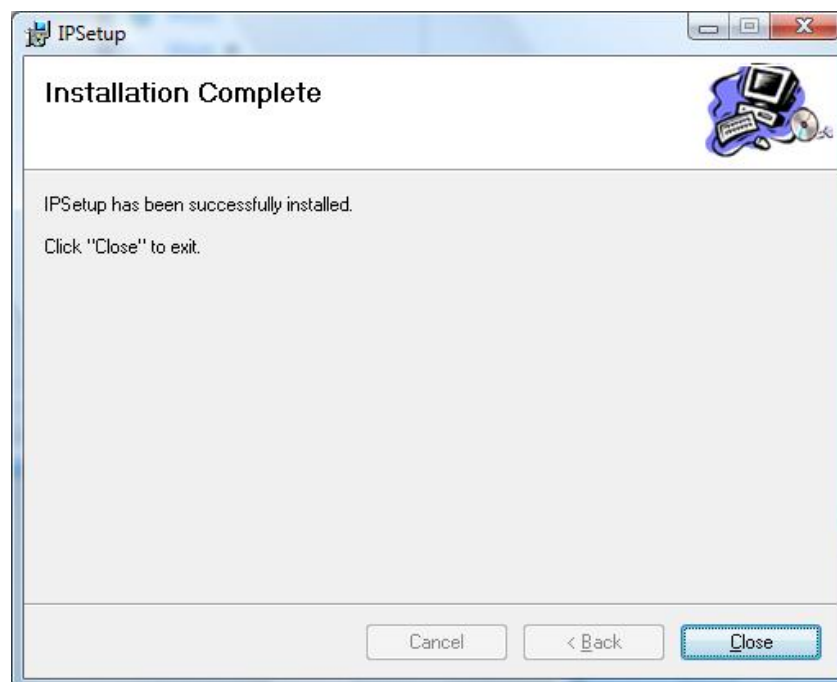

6. After installing the IPSetup utility, the application is automatically installed to your computer, and creates a folder in " **Start \Program\TRENDnet\IPSetup**".

7. Click **Start > Programs > TRENDnet > IPSetup**, and then click **IPSetup**

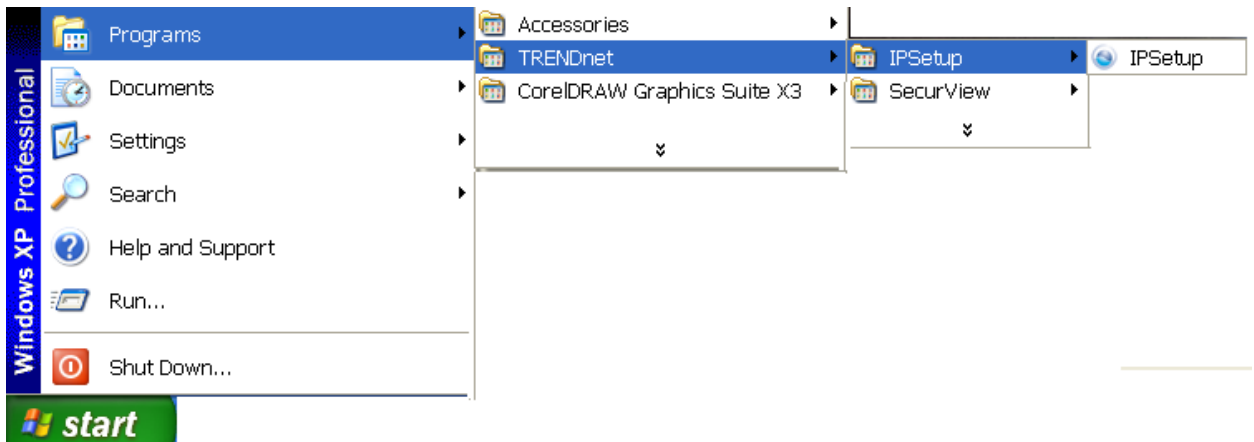

8. The IPSetup window will appear. It will search the Camera within the same network.

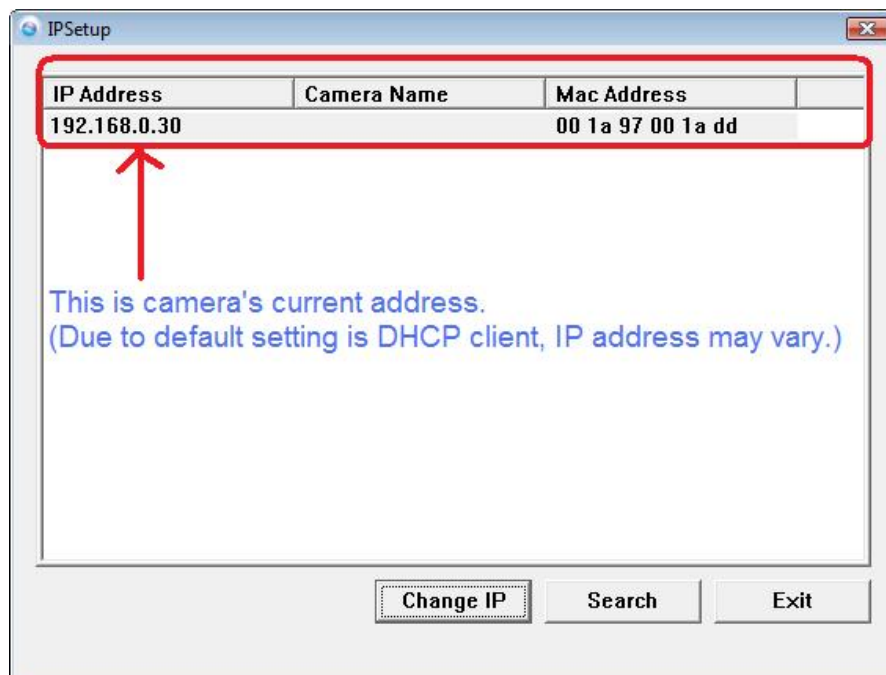

- **Camera Display Area:** It shows the connected camera(s) within the same network

Double click the IP address, it will link to Camera's Web Configuration page.

- **Change IP:** Click this button to bring up the following window. It allows you to change the IP Address. You can select either **Static IP** or click **DHCP**. Then, enter the Administrator ID & password. By default ID/password is: admin. When complete, click "**Change**".

The screenshot shows a dialog box titled "Change IP Address". It contains two radio buttons: "Static IP" (selected) and "DHCP". Under "Static IP", there are three input fields: "IP Address" (192 . 168 . 1 . 1), "Submask" (255 . 255 . 255 . 0), and "Default gateway" (192 . 168 . 1 . 254). Below these is a section for "Administrator ID \_Password" with two input fields: "ID" and "Password". At the bottom are two buttons: "Change" and "Exit".

- **Search:** Click this button to search the connected camera in the same network.”
- **Exit:** Click this button to exit the program.

## 3.2 Accessing to the Camera

1. Open the Web browser on your computer (example showed in the User's Guide is based on the Internet Explorer)
2. Type the Camera IP address (For example, if your DHCP server assign is as 192.168.10.30) in the web browser URL and then press [Enter].

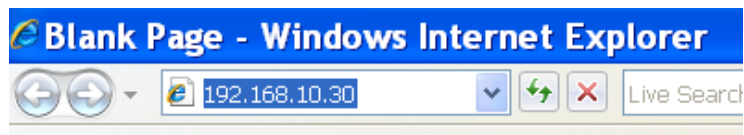

3. You can also double click on the selected camera from IPSetup which will open IE browser.

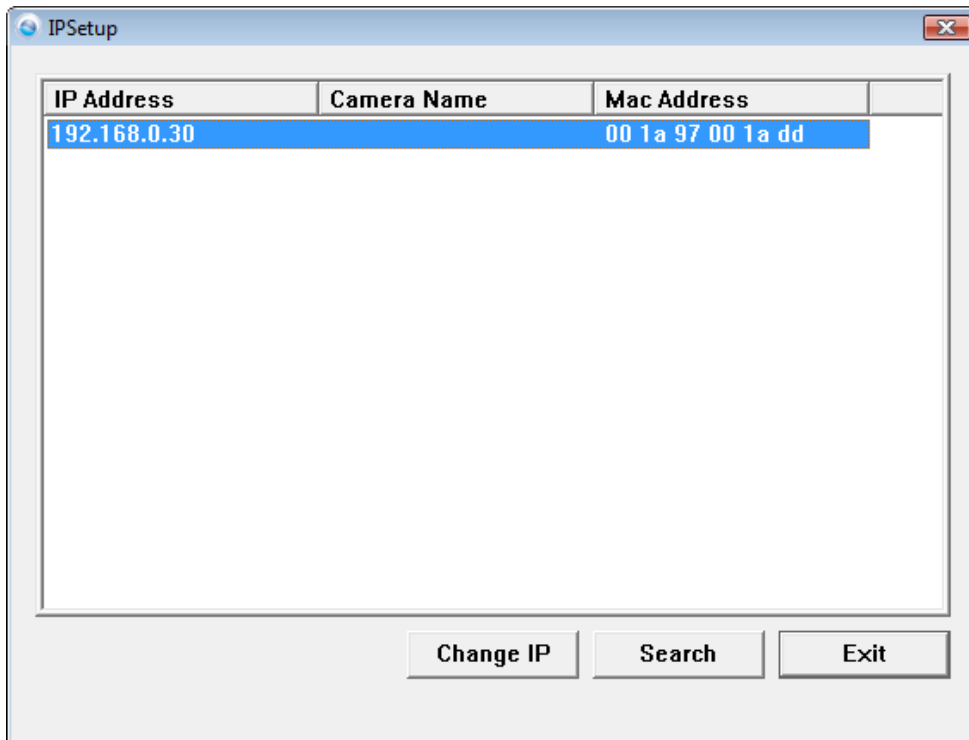

4. When the login window appears, enter the default User name (**admin**) and password (**admin**) and press **OK** to access to the main screen of the camera's Web Configuration.

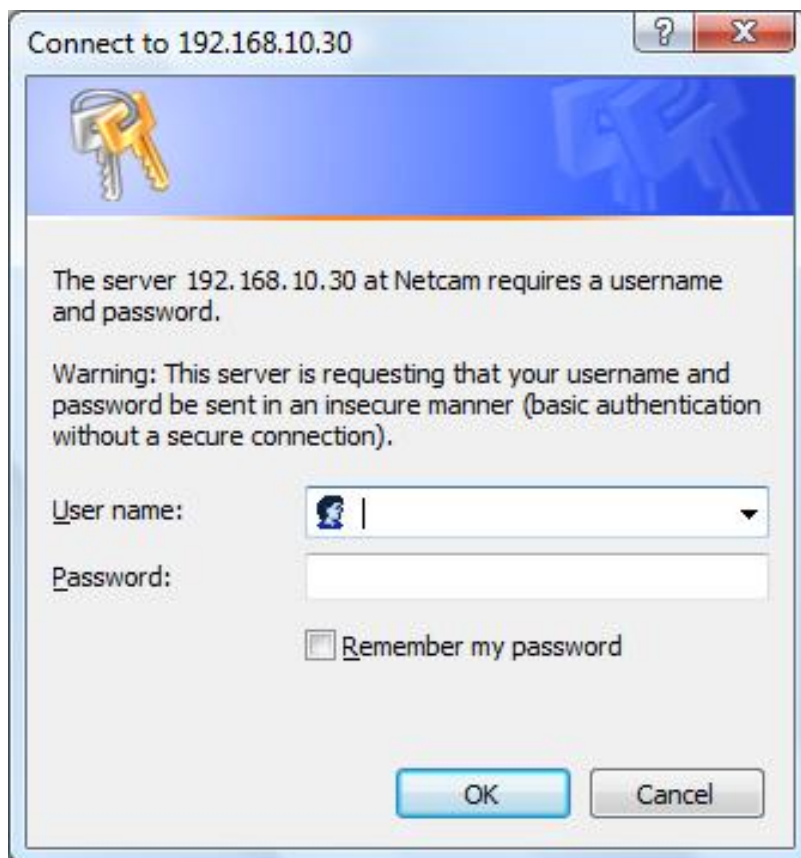

**NOTE** If you are initially access to the camera, you will be ask to install a new plug-in for the camera. Permission request depends on the Internet security settings of your computer. Click **Yes** to proceed.



After you login into the Web Configuration of the camera, the main page will appear as below:

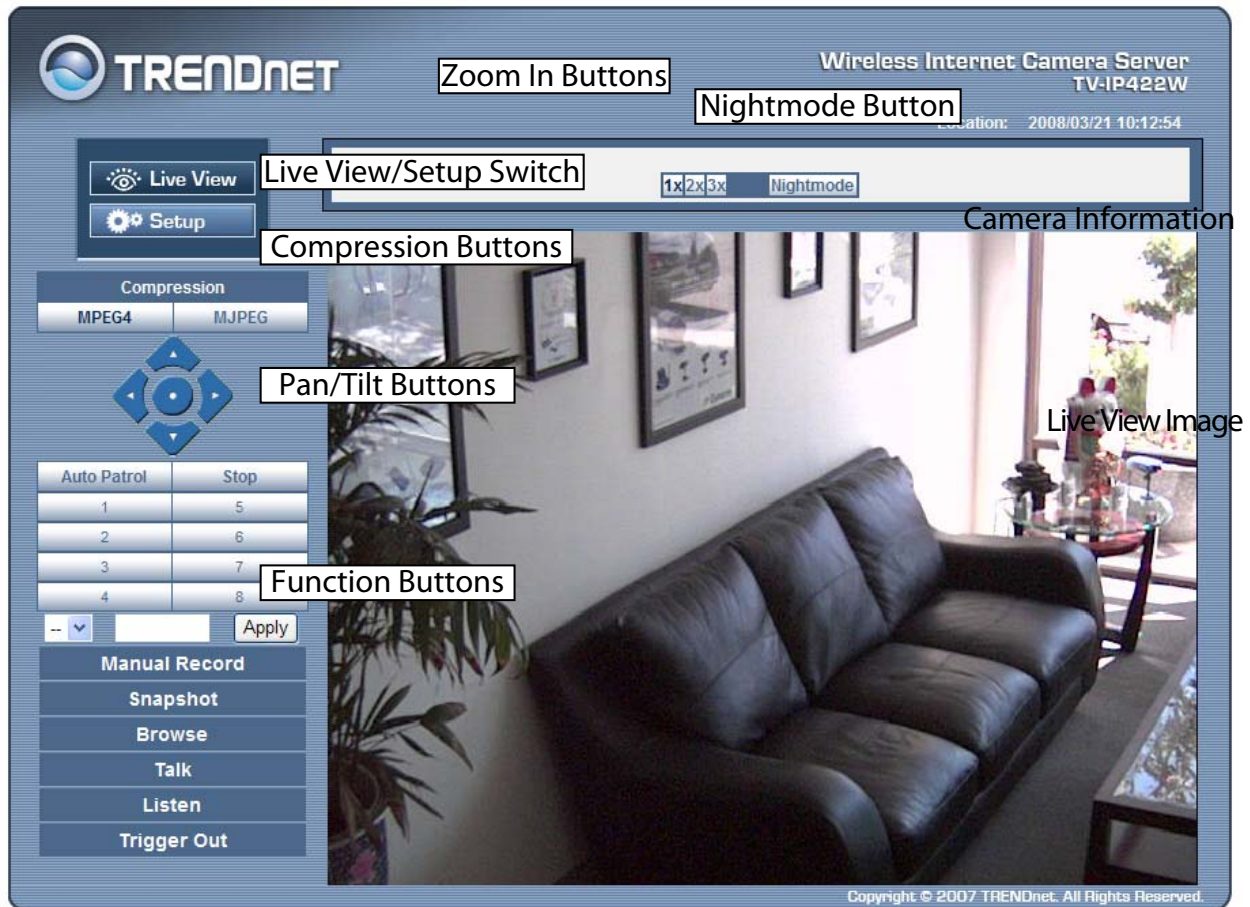

The main page of the Web Configuration provides you with many useful information and functions, including:

- **Camera Information** – Displays the camera’s location and the current date & time. The information can be modified in the Web Configuration.
- **Live View Image** – Displays the real-time image of the connected camera.

- Move your mouse to the Live View area and click on anywhere, the camera lens will then move to the position where you clicked to display it in the central part of Live View area.
  - When you enlarge the Live View by clicking the Zoom In buttons (2x or 3x), you can move the displayed image by right-clicking your mouse on the Live View area. The position where you right-clicked will be displayed in the central part of Live View area.
- **Zoom In Buttons** – Click the buttons to zoom in the live view image by 1x, 2x, and 3x.
  - **Nightmode Button** – Click the button to enable the “nightshot mode” to deliver clearer images in the dark environment. However, this will reduce the frame rate of video setting.
  - **Live View/Setup Switch** – Click **Setup** to configure the camera. For details, see Chapter 4.
  - **Compression Buttons** – Select to transmit and record the video using MPEG4 or MJPEG compression.
  - **Pan/Tilt Buttons** – Provides the buttons to control the camera lens:
    - **Left/Right/Up/Down/Home** buttons allow you to move the camera lens position. Clicking the **Home** button will move the camera lens to the assigned home position.



- **Auto Patrol** button controls the camera to automatically scan the preset positions once. Click **Stop** to stop patrolling.
- Click the **Number button** (1~8) to move the camera lens to the preset position immediately.

To set up the preset positions, move the camera lens by clicking the Left/Right/Up/Down buttons to the desired position first, then select the number (1~8) from the pull-down list and click the **Apply** button. You can enter a descriptive name for the assigned position in the text box to identify it easily.

- **Function Buttons** – Use these buttons to control the audio, video, and trigger functions.
  - **Manual Record** allows you to record and save a video clip.
  - **Snapshot** allows you to capture and save a still image.
  - **Browse** allows you to assign the destination folder to store the video clips and still images.
  - **Talk** allows you to speak out through the camera. Please note only one user is allowed to use this function at a time.
  - **Listen** allows you to receive the on-site sound and voice from the camera.
  - **Trigger Out** allows you to trigger on/off the GPIO output manually.

### 3.3 Configuring the IP Address of the PC

If you are failed to access to the camera, please check the IP address of your computer. When you connect the camera to your computer directly to proceed with configuration of the camera, you need to set up the IP addresses to be in the same segment for the two devices to communicate.

1. On your computer, click **Start > Control Panel** to open the Control Panel window.
2. Double-click **Network Connection** to open the Network Connection window.
3. Right-click **Local Area Connection** and then click **Properties** from the shortcut menu.
4. When the Local Area Connection Properties window appears, select the **General** tab.
5. Select **Internet Protocol [TCP/IP]** and then click **Properties** to bring up the Internet Protocol [TCP/IP] Properties window.
6. To configure a fixed IP address that is within the segment of the camera, select the **Use the following IP address** option. Then, enter an IP address into the empty field. The suggested IP address is **192.168.xxx.xxx** (x is 0~254, please avoid same IP address with your network devices), and the suggested Subnet mask is **255.255.255.0**.
7. When you are finished, click **OK**.

# CHAPTER 4

---

## CONFIGURING THE CAMERA

### 4.1 Using the Web Configuration

You can access and manage the camera through the Web browser and the provided software application SecurView. This chapter describes the Web Configuration, and guides you through the configuration of the camera by using the Web browser.

To configure the camera, click **Setup** on the main page of Web Configuration. The Web Configuration will start from the **Basic** page.

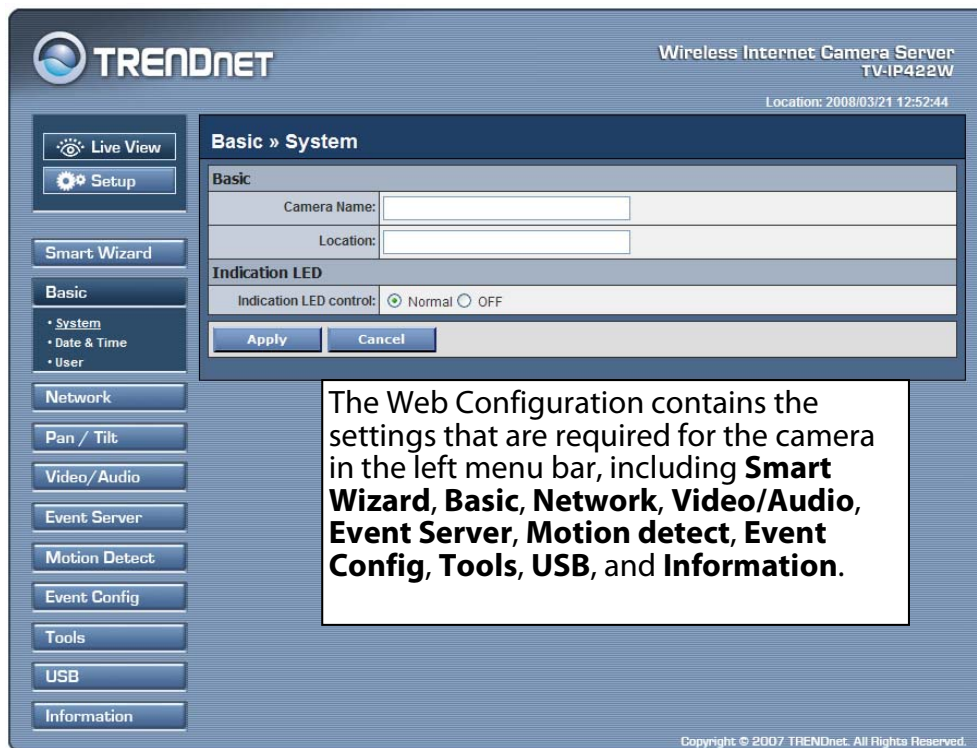

Enter the desired camera name and location, then click **Apply**. You can also configure the camera by using the **Smart Wizard** as describe below.

Basic » System	
<b>Basic</b>	
Camera Name:	<input type="text" value="TV-IP422"/>
Location:	<input type="text" value="Office1"/>
<b>Indication LED</b>	
Indication LED control:	<input checked="" type="radio"/> Normal <input type="radio"/> OFF
<input type="button" value="Apply"/> <input type="button" value="Cancel"/>	

## 4.2 Using Smart Wizard

The camera's Smart Wizard lets you configure your camera easily and quickly. The wizard will guide you through the necessary settings with detailed instructions on each step.

To start the wizard, click **Smart Wizard** in the left menu bar.



### Step 1. Camera Settings

Enter desired **Camera Name**, **Location** and **Admin Password**. By default, the password is **admin**. You can also leave the password field blank. It is highly recommend that you enter the new password. Once you have



changed to new password, please keep a record. You will need the new password to view or configure the camera later on.

**TRENDNET** Wireless Internet Camera Server TV-IP422W  
Location: testing 2008/04/04 11:18:21

**Welcome to the Smart Wizard.**  
This wizard will help you quickly set up the Network Camera to run on your network.

**Camera Settings**

**Camera Name:** Enter a descriptive name for the camera. For example, camera 1.

**Location:** Enter a descriptive name for the location used by the camera. For example, meeting room 1.

**Admin Password/Confirm Password:** Enter the administrator password twice to set and confirm the password to access the camera's Configuration Utility.

Camera Name:	TV-IP422
Location:	Warehouse
Admin Password:	.....
Confirm Password:	.....

Copyright: © 2007 TRENDnet. All Rights Reserved.

## Step 2. IP Settings

Choose **DHCP**, **Static IP** or **PPPoE**

### IP Settings

DHCP

Static IP

IP: 192 . 168 . 1 . 1

Subnet Mask: 255 . 255 . 255 . 0

Default Gateway: 192 . 168 . 1 . 254

Primary DNS: . . . .

Secondary DNS: . . . .

PPPoE

User Name:

Password:

### Step 3. Email Settings

Enter mail server information for sending still image to email account.

Email Setting	
SMTP Server Address:	<input type="text" value="mailserver.com"/>
Sender Email Address:	<input type="text" value="joe@mailserver.com"/>
Authentication Mode:	<input type="radio"/> None <input checked="" type="radio"/> SMTP
Sender User Name:	<input type="text" value="Joe"/>
Sender Password:	<input type="password" value="•••••"/>
Receiver #1 Email Address:	<input type="text" value="lisa@mailserver.com"/>
Receiver #2 Email Address:	<input type="text" value="andy@mailserver.com"/>
<input data-bbox="212 846 383 890" type="button" value=" &lt; Prev "/> <input data-bbox="391 846 561 890" type="button" value=" Next &gt; "/> <input data-bbox="570 846 740 890" type="button" value=" Cancel "/>	

### Step 4. Wireless Networking

Enter wireless network information

Wireless Networking	
Network ID(SSID):	<input type="text" value="TRENDnet"/> <input data-bbox="748 1178 919 1222" type="button" value=" Site Survey "/>
Wireless Mode:	<input checked="" type="radio"/> Infrastructure <input type="radio"/> Ad-Hoc
Channel:	<input type="text" value="6"/>
Authentication:	<input type="text" value="Open"/>
Encryption:	<input checked="" type="radio"/> None <input type="radio"/> WEP
Format:	<input checked="" type="radio"/> ASCII <input type="radio"/> HEX
Key Length:	<input checked="" type="radio"/> 64 bits <input type="radio"/> 128 bits
<input checked="" type="radio"/> WEP Key 1	<input type="text"/>
<input type="radio"/> WEP Key 2	<input type="text"/>
<input type="radio"/> WEP Key 3	<input type="text"/>
<input type="radio"/> WEP Key 4	<input type="text"/>
<input data-bbox="212 1772 383 1816" type="button" value=" &lt; Prev "/> <input data-bbox="391 1772 561 1816" type="button" value=" Next &gt; "/> <input data-bbox="570 1772 740 1816" type="button" value=" Cancel "/>	

## Step 5. Confirm Settings

Review your setting. Click Apply to save the setting and reboot the camera. Click **<Prev** to go back to previous setting. Click **Cancel** to existing the setting without any changes.

Confirm Settings	
Camera Name:	TV-IP422
Location:	Warehouse
IP MODE:	DHCP
IP Address:	192.168.1.1
Subnet Mask:	255.255.255.0
Default Gateway:	192.168.1.254
Primary DNS:	
Secondary DNS:	
SMTP Server Address:	mailserver.com
Sender Email Address:	joe@mailserver.com
Authentication Mode:	SMTP
Sender User Name:	Joe
Receiver #1 Email Address:	lisa@mailserver.com
Receiver #2 Email Address:	andy@mailserver.com
ESSID:	TRENDnet
Connection:	Infrastructure
Channel:	6
Authentication:	Open
Encryption:	None
<input data-bbox="212 1486 380 1528" type="button" value=" &lt; Prev "/> <input data-bbox="391 1486 558 1528" type="button" value=" Apply "/> <input data-bbox="570 1486 737 1528" type="button" value=" Cancel "/>	

## 4.3 Basic Setup

The Basic menu contains three sub-menus that provide the system settings for the camera, such as the Camera Name, Location, Date & Time, and User management.

### Basic >> System

The screenshot displays the configuration interface for a TRENDnet Wireless Internet Camera Server (TV-IP422W). The interface is titled "Basic » System" and includes a sidebar with navigation options: Live View, Setup, Smart Wizard, Basic (with sub-items System, Date & Time, and User), Network, Pan / Tilt, Video/Audio, Event Server, Motion Detect, Event Config, Tools, USB, and Information. The main content area shows the following settings:

Basic	
Camera Name:	TV-IP422W
Location:	Office1
Indication LED	
Indication LED control:	<input checked="" type="radio"/> Normal <input type="radio"/> OFF

At the bottom of the settings area are "Apply" and "Cancel" buttons. The top right corner of the interface shows the location and time: "Location: testing2008/04/04 13:13:00". The bottom right corner contains the copyright notice: "Copyright © 2007 TRENDnet. All Rights Reserved."

#### ■ Basic

- **Camera Name:** Enter a descriptive name for the camera.
- **Location:** Enter a descriptive name for the location used by the camera.

#### ■ Indication LED

This item allows you to set the LED illumination as desired. There are two options: **Normal** and **OFF**.

## Basic >> Date & Time

The screenshot shows the web interface for a TrendNet Wireless Internet Camera Server (TV-IP422W). The page title is "Basic » Date & Time". The interface includes a sidebar with navigation buttons: Live View, Setup, Smart Wizard, Basic (with sub-items: System, Date & Time, User), Network, Pan / Tilt, Video/Audio, Event Server, Motion Detect, Event Config, Tools, USB, and Information. The main content area is titled "Date and Time" and contains the following settings:

- TimeZone: (GMT) Greenwich Mean Time : Dublin, Edinburgh, Lisbon, London (dropdown menu)
- Setting:  Synchronize with PC,  Synchronize with NTP Server
- NTP Server Address: [text input field]
- Update Interval: 6 (dropdown menu) hours
- Manual
- Date: 2008/04/04 (YYYY/MM/DD)
- Time: 13:14:11 (hh:mm:ss)

At the bottom of the configuration area are "Apply" and "Cancel" buttons. The footer of the interface reads "Copyright © 2007 TRENDnet. All Rights Reserved."

- **TimeZone:** Select the proper time zone for the region from the pull-down menu.
- **Synchronize with PC:** Select this option and the date & time settings of the camera will be synchronized with the connected computer.
- **Synchronize with NTP Server:** Select this option and the time will be synchronized with the NTP Server. You need to enter the IP address of the server and select the update interval in the following two boxes.

- **Manual:** Select this option to set the date and time manually.

## Basic >> User

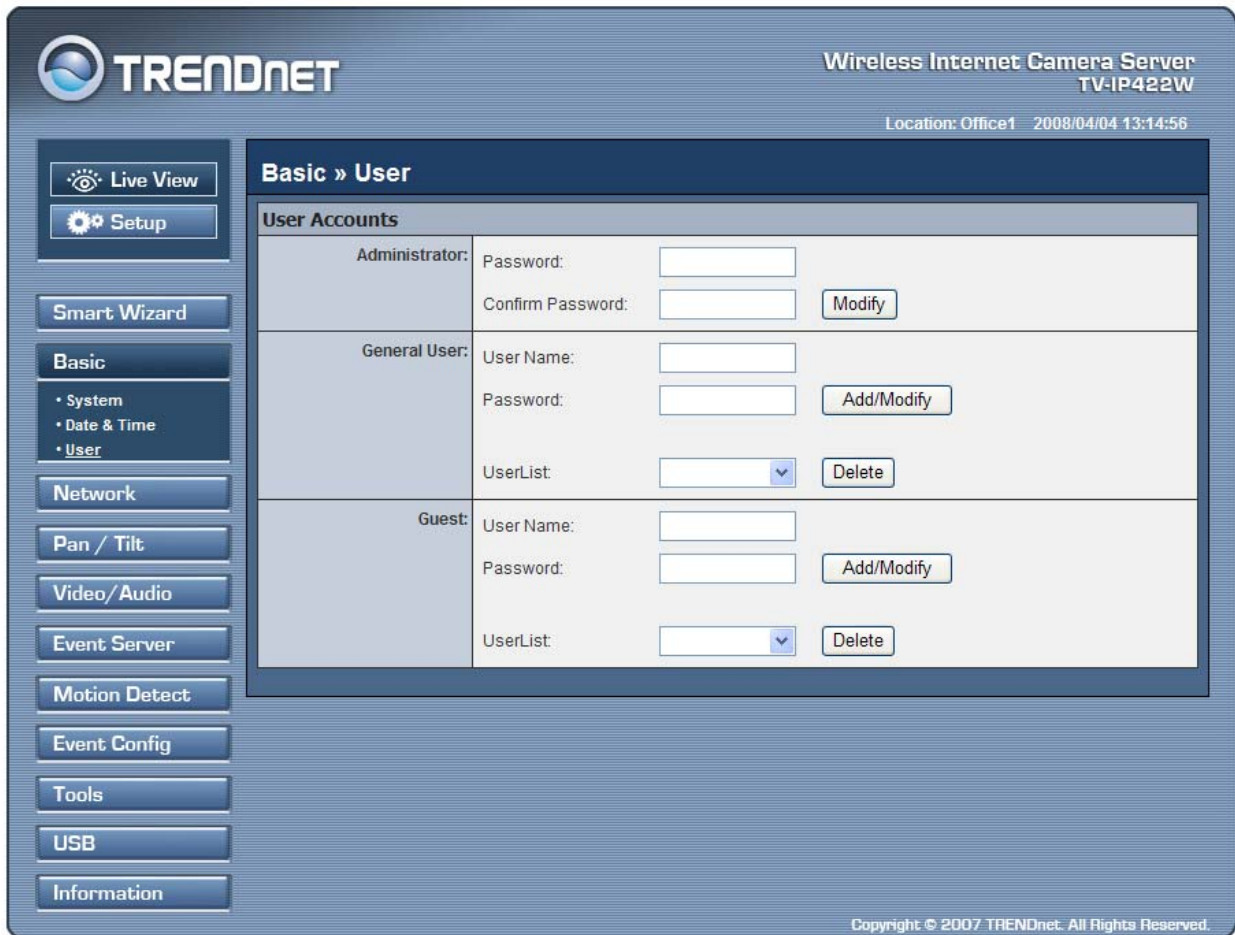

Wireless Internet Camera Server  
TV-IP422W  
Location: Office1 2008/04/04 13:14:56

**Basic » User**

**User Accounts**

Administrator:	Password: <input type="text"/>	Confirm Password: <input type="text"/>	<input type="button" value="Modify"/>
General User:	User Name: <input type="text"/>	Password: <input type="text"/>	<input type="button" value="Add/Modify"/>
	UserList: <input type="text"/>	<input type="button" value="Delete"/>	
Guest:	User Name: <input type="text"/>	Password: <input type="text"/>	<input type="button" value="Add/Modify"/>
	UserList: <input type="text"/>	<input type="button" value="Delete"/>	

Copyright © 2007 TRENDnet. All Rights Reserved.

### ■ Administrator

To prevent unauthorized access to the camera's Web Configuration, you are strongly recommend to change the default administrator password. Type the administrator password twice to set and confirm the password.

### ■ General User

- **User Name:** Enter the user's name you want to add to use the camera.
- **Password:** Enter the password for the new user.

When you are finished, click **Add/Modify** to add the new user to the camera. To modify the user's information, select the one you want to modify from **UserList** and click **Add/Modify**.

- **UserList:** Display the existing users of the camera. To delete a user, select the one you want to delete and click **Delete**.

## ■ Guest

- **User Name:** Enter the guest's name you want to add to use the camera.
- **Password:** Enter the password for the new guest.
- **UserList:** Display the existing guests of the camera. To delete a user, select the one you want to delete and click **Delete**.

**NOTE** The "General User" can access the camera and control the Function buttons of the camera's Web Configuration; the "Guest" can only view the live view image from the main page of the Web Configuration while accessing the camera. Only the "Administrator" is allowed to configure the camera through the Web Configuration.



## 4.4 Network Settings

The Network menu contains three sub-menus that provide the network settings for the camera, such as the IP Setting, DDNS Setting, IP Filter, and Wireless network.

### Network >> Network

The screenshot displays the web interface for a Trendnet Wireless Internet Camera Server (TV-IP422W). The interface is titled "Network » Network" and shows various configuration options. The left sidebar contains navigation buttons for Live View, Setup, Smart Wizard, Basic, Network (with sub-items Network, IP Filter, and Wireless), Pan / Tilt, Video / Audio, Event Server, Motion Detect, Event Config, Tools, USB, and Information. The main content area is divided into several sections:

- IP Settings:** Includes radio buttons for DHCP (selected) and Static IP. Below are input fields for IP (192.168.1.1), Subnet Mask (255.255.255.0), Default Gateway (192.168.1.254), Primary DNS, and Secondary DNS. There are also fields for PPPoE User Name and Password.
- DDNS Setting:** Includes a checkbox for "Enable" (unchecked), a dropdown menu for "Provider" (set to dyndns.org), and input fields for Host Name, User Name, and Password.
- UPnP:** Includes a checkbox for "Enable" (checked).
- Bonjour:** Includes a checkbox for "Enable" (checked) and an input field for "Friendly Name".
- Ports Number:** Includes input fields for HTTP Port (80, default 80) and RTSP Port (554, default 554).

At the bottom of the main content area are "Apply" and "Cancel" buttons. The footer of the interface reads "Copyright © 2007 TRENDnet. All Rights Reserved."

#### ■ IP Setting

This item allows you to select the IP address mode and set up the related configuration. The default setting is **DHCP** mode enabled.

- **DHCP:** Select this option when your network uses the DHCP server. When the camera starts up, it will be assigned an IP address from the DHCP server automatically.
- **Static IP:** Select this option to assign the IP address for the camera directly. You can use IPSetup to obtain the related setting values.

<b>IP</b>	Enter the IP address of the camera. The default setting is DHCP.
<b>Subnet Mask</b>	Enter the Subnet Mask of the camera. The default setting is <b>255.255.255.0</b> .
<b>Default Gateway</b>	Enter the Default Gateway of the camera. The default setting is <b>your router's LAN IP address</b> .
<b>Primary/ Secondary DNS</b>	DNS (Domain Name System) translates domain names into IP addresses. Enter the Primary DNS and Secondary DNS that are provided by ISP.

- **PPPoE:** Select this option when you use a direct connection via the ADSL modem. You should have a PPPoE account from your Internet service provider. Enter the **User Name** and **Password**. The camera will get an IP address from the ISP as starting up.

**NOTE** Once the camera get an IP address from the ISP as starting up, it automatically sends a notification email to you. Therefore, when you select PPPoE as your connecting type, you have to set up the email or DDNS configuration in advance.

## ■ DDNS Setting

With the Dynamic DNS feature, you can assign a fixed host and domain name to a dynamic Internet IP address. Select the **Enable** option to enable this feature. Then, select the Provider from the pull-down list and enter the required information in the **Host Name**, **User Name**, and **Password** boxes. Please note that you have to sign up for DDNS service with the service provider first.

## ■ UPNP

The camera supports UPnP (Universal Plug and Play), which is a set of computer network protocols that enable the device-to-device interoperability. In addition, it supports port auto mapping function so that you can access the camera if it is behind an NAT router or firewall. Select the **Enable** option to enable this feature.

## ■ Ports Number

- **HTTP Port:** The default HTTP port is **80**.
- **RTSP Port:** Configure the transmission of streaming data within the network. The default RTSP (Real Time Streaming Protocol) port is **554**.

**NOTE** If the camera is behind an NAT router or firewall, the suggested to be used is from 1024 to 65535.

## Network >> IP Filter

The IP Filter setting allows the administrator of the camera to limit the users within a certain range of IP addresses to access the camera.

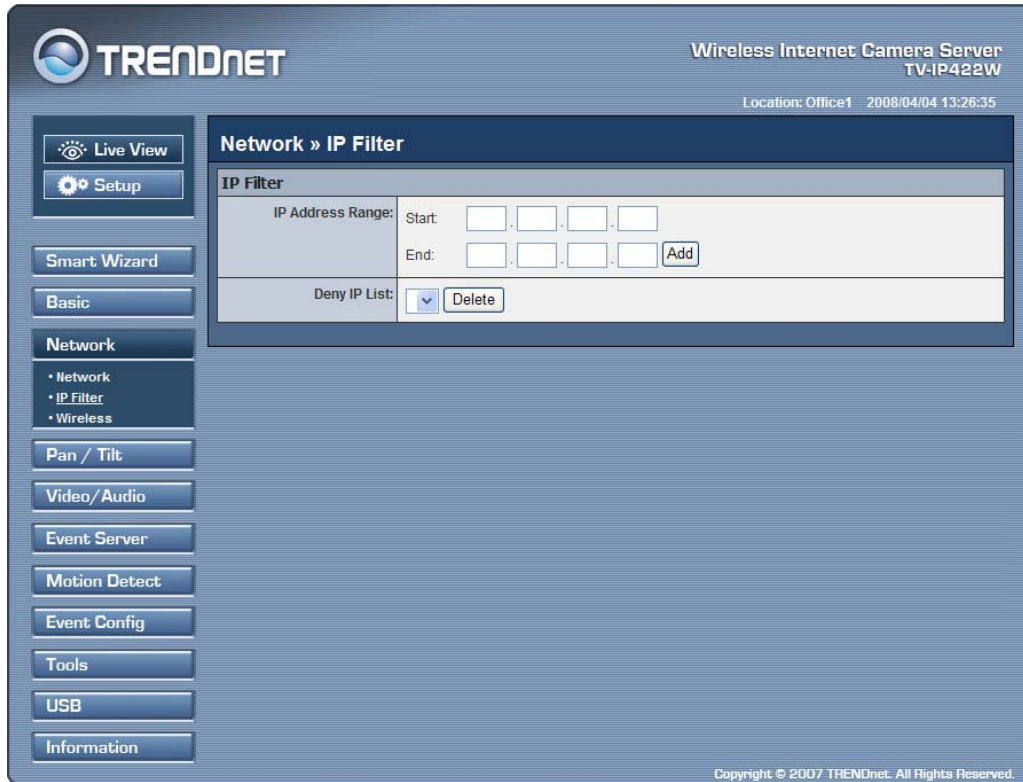

### ■ Start/End IP Address

Assign a range of IP addresses that are not allowed to access the camera by entering the Start IP address and End IP address. When you are finished, click **Add** to save the range setting. You can repeat the action to assign multiple ranges for the camera.

For example, when you enter 192.168.10.50 in Start IP Address and 192.168.10.80 in End IP Address, the user whose IP address located within 192.168.10.50 ~ 192.168.10.80 will not be allowed to access the camera.

## ■ Deny IP List

The list displays the range setting(s) of IP addresses that are not allowed to access the camera. To clear the setting, select a range of IP addresses from the list and click **Delete**.

## Network >> Wireless Setting

The camera supports WLAN while you use the wireless network. Select the **Enable** option to enable this feature.

The screenshot displays the configuration interface for a TRENDnet Wireless Internet Camera Server (TV-IP422W). The main content area is titled "Network » Wireless Setting". Under the "Wireless" section, the "Enable" checkbox is checked. The "Network ID (SSID)" is set to "TRENDnet", with a "Site Survey" button next to it. The "Wireless Mode" is set to "Infrastructure" (selected with a radio button), and "Ad-Hoc" is unselected. The "Channel" is set to "6" via a dropdown menu, and "Authentication" is set to "Open". Below these settings, the "Encryption" is set to "None" (selected), and "WEP" is unselected. The "Format" is set to "ASCII" (selected), and "HEX" is unselected. The "Key Length" is set to "64 bits" (selected), and "128 bits" is unselected. There are four input fields for "WEP Key 1", "WEP Key 2", "WEP Key 3", and "WEP Key 4", all of which are currently empty. At the bottom of the configuration area, there are "Apply" and "Cancel" buttons. The sidebar on the left contains navigation options: Live View, Setup, Smart Wizard, Basic, Network (with sub-options for Network, IP Filter, and Wireless), Pan / Tilt, Video / Audio, Event Server, Motion Detect, Event Config, Tools, USB, and Information. The top right corner shows the device name "Wireless Internet Camera Server TV-IP422W" and the location/time "Location: Office1 2008/04/04 13:28:11". The bottom right corner has a copyright notice: "Copyright © 2007 TRENDnet. All Rights Reserved."

- **Network ID (SSID):** Keep the default setting of this option to connect the camera to any access point under the infrastructure network mode. To connect the camera to a specified access point, set a SSID for the camera to correspond with the access point's ESS-ID. To connect the camera to an Ad-Hoc wireless workgroup, set the same wireless channel and SSID to match with the computer's configuration.

Click **Site Survey** to display the available wireless networks, so that you can easily connect to one of the listed wireless networks.

- **Wireless Mode:** Select the type of wireless communication for the camera: **Infrastructure** or **Ad-Hoc**.
- **Channel:** Select the appropriate channel from the list.
- **Authentication:** Select the authentication method to secure the camera from being used by unauthorized user: **Open**, **Shared-key**, **WPA-PSK**, and **WPA2-PSK**. The following table explains the four options:

<b>Open</b>	The default setting of Authentication mode, which communicates the key across the network.
<b>Shared-key</b>	Allow communication only with other devices with identical WEP settings.
<b>WPA-PSK/ WPA2-PSK</b>	WPA-PSK/WPA2-PSK is specially designed for the users who do not have access to network authentication servers. The user has to manually enter the starting password in their access point or gateway, as well as in each PC on the wireless network.

If you select **Open** or **Shared-key** as the Authentication mode, you need to complete the following settings:

**Encryption:** Select the **WEP** option to enable the data encryption feature to secure the camera within the wireless network.

**Format:** Once you enable the Encryption feature, you need to determine the encryption format by selecting **ASCII** or **HEX**. ASCII format causes each character you type to be interpreted as an eight-bit value. Hex format causes each pair of characters you type to be interpreted as an eight-bit value in hexadecimal (base 16) notation.

**Key Length:** Select the WEP key length you use: **64 bits** or **128 bits**.

**WEP Key 1/2/3/4:** Enter the WEP key(s) in the following boxes.

If you select **WPA-PSK** or **WPA2-PSK** as the Authentication mode, you need to complete the following settings:

**Encryption:** Select **TKIP** or **AES**. TKIP (Temporal Key Integrity Protocol) changes the temporal key every 10,000 packets to insure much greater security than the standard WEP security. AES (Advanced Encryption Standard) is used to ensure the highest degree of security and authenticity for digital information.

**Pre-Shared Key:** This is used to identify each other in the network. Enter the name in the box, and this name must match the Pre-shared key value in the remote device.

## 4.5 Pan/Tilt Settings

The Pan/Tilt menu allows you to configure the pan/tilt functions of the camera.

### Pan & Tilt >> Pan & Tilt Settings





- **Pan/Tilt Calibration:** Click **Calibration** to calibrate the position of the camera lens.
- **Pan Steps:** Set the changing range (1~20 degrees) when you click the Left/Right button.
- **Tilt Steps:** Set the changing range (1~20 degrees) when you click the Up/Down button.
- **Auto Patrol Stay Time:** Set the stay time (1~999 seconds) of each preset positions when the camera is patrolling.

## 4.6 Setting up Video & Audio

The Video & Audio menu contains three sub-menus that provide the video and audio settings for the camera.

### Video & Audio >> Camera

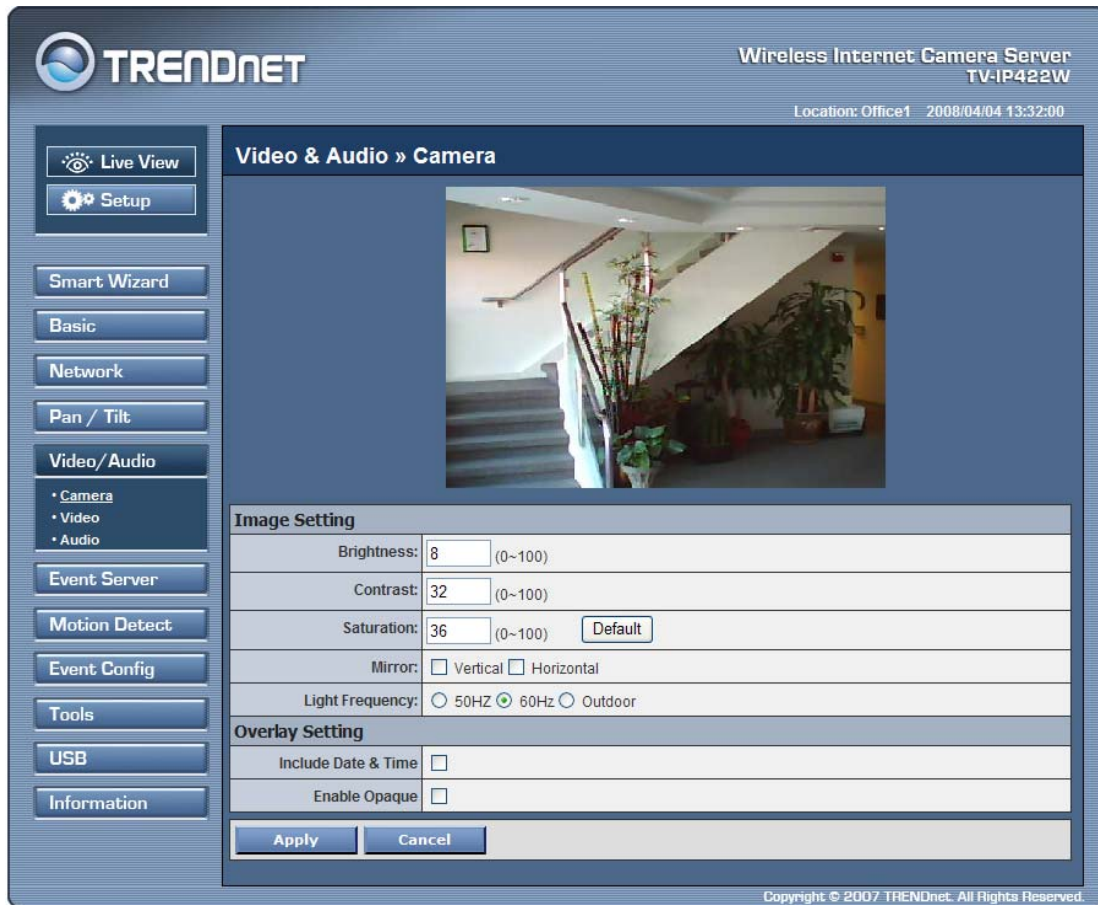

The screenshot displays the configuration interface for a TRENDnet Wireless Internet Camera Server (TV-IP422W). The interface is titled "Video & Audio » Camera" and features a live view window showing a staircase. The configuration options are organized into two sections: "Image Setting" and "Overlay Setting".

Image Setting	
Brightness:	8 (0~100)
Contrast:	32 (0~100)
Saturation:	36 (0~100) <input type="button" value="Default"/>
Mirror:	<input type="checkbox"/> Vertical <input type="checkbox"/> Horizontal
Light Frequency:	<input type="radio"/> 50HZ <input checked="" type="radio"/> 60HZ <input type="radio"/> Outdoor

Overlay Setting	
Include Date & Time	<input type="checkbox"/>
Enable Opaque	<input type="checkbox"/>

Buttons:

Copyright © 2007 TRENDnet. All Rights Reserved.

#### ■ Image Setting

- **Brightness:** Adjust the brightness level from 0 ~ 100.
- **Contrast:** Adjust the contrast level from 0 ~ 100.
- **Saturation:** Adjust the colors level from 0 ~ 100.

Click **Default** to restore the default settings of the three options above.

- **Mirror:** Select the **Horizontal** option to mirror the image horizontally. Select the **Vertical** option to mirror the image vertically.
- **Light Frequency:** Select the proper frequency according to the camera's location: **50Hz**, **60Hz**, or **Outdoor**.

#### ■ **Overlay Setting**

- **Includes Date & Time:** Select this option to display the date & time stamp on the live view image.
- **Enable Opaque:** Select this option to set a black background to the displayed date & time stamp.

## Video & Audio >> Video

The screenshot shows the configuration interface for a Trendnet Wireless Internet Camera Server (TV-IP422W). The page is titled "Video & Audio » Video" and displays settings for three video formats: MPEG4, MJPEG, and 3GPP. The left sidebar contains navigation buttons for Live View, Setup, Smart Wizard, Basic, Network, Pan / Tilt, Video/Audio (with sub-items for Camera, Video, and Audio), Event Server, Motion Detect, Event Config, Tools, USB, and Information. The top right corner shows the location as "Office1" and the date/time as "2008/04/04 13:54:17".

Format	Video Resolution	Video Quality	Frame Rate	Setting
MPEG4	VGA	Highest	30 fps	
MJPEG	VGA	High	30 fps	
3GPP				<input checked="" type="radio"/> Disable <input type="radio"/> 3GPP Without Audio <input type="radio"/> 3Gpp With Audio

Buttons: Apply, Cancel

Copyright © 2007 TRENDnet. All Rights Reserved.

### ■ MPEG4

- **Video Resolution:** Select the desired video resolution from the three formats: **VGA**, **QVGA** and **QQVGA**. The higher setting (VGA) obtains better video quality while it uses more resource within your network.
- **Video Quality:** Select the desired image quality from five levels: **Lowest**, **Low**, **Medium**, **High**, and **Highest**.
- **Frame Rate:** Select **Auto** or a proper setting depending on your network status.

## ■ MJPEG

- **Video Resolution:** Select the desired video resolution from the three formats: **VGA**, **QVGA** and **QQVGA**. The higher setting (VGA) obtains better video quality while it uses more resource within your network.
- **Video Quality:** Select the desired image quality from five levels: **Lowest**, **Low**, **Medium**, **High**, and **Highest**.
- **Frame Rate:** Select **Auto** or a proper setting depending on your network status.

**NOTE** The camera supports both MPEG4 and MJPEG compression. MJPEG capture the images in JPEG format, which require higher bandwidth to view smooth video. The administrator can control the bandwidth of each connection well through the setting options above.

## ■ 3GPP

The camera supports 3GPP specification. Select the **Disable** option to disable this feature. Otherwise, select **3GPP Without Audio** or **3GPP With Audio** to transfer the video clips without or with audio.

If you use a mobile phone that supports 3GPP, you can also view the real-time streaming image captured by the camera on your phone (with the default player on the phone) by entering the RTSP link:  
[rtsp://\(IP address of the camera\)/3gp](rtsp://(IP address of the camera)/3gp).

**NOTE** Your mobile phone and the service provider must support 3GPP function. Please contact your service provider when you are failed to use this service.

## Video & Audio >> Audio

The screenshot shows the configuration interface for a Trendnet Wireless Internet Camera Server (TV-IP422W). The page title is "Video & Audio » Audio". The interface includes a sidebar with navigation options: Live View, Setup, Smart Wizard, Basic, Network, Pan / Tilt, Video/Audio (with sub-options for Camera, Video, and Audio), Event Server, Motion Detect, Event Config, Tools, USB, and Information. The main content area is titled "Video & Audio » Audio" and contains two sections: "Camera Microphone In" and "Camera Speaker Out".

Camera Microphone In	
Enable	<input checked="" type="checkbox"/>

Camera Speaker Out	
Enable	<input checked="" type="checkbox"/>
Volume:	<input type="text" value="90"/>

At the bottom of the configuration area are "Apply" and "Cancel" buttons. The footer of the page reads "Copyright © 2007 TRENDnet. All Rights Reserved."

### ■ Camera Microphone In

Select the **Enable** option to enable the camera's audio function, so that you can receive the on-site sound and voice from the camera.

### ■ Camera Speaker Out

Select the **Enable** option to enable the camera's external speaker function, so that the connected speaker can play the sound and voice through the camera.

- **Volume:** Set the speaker's volume.

## 4.7 Event Server Configuration

The Event Server menu contains three sub-menus that allow you to upload images to FTP, send emails that include still images, and store the images to a NAS system.

When you complete the required settings for FTP, Email, or Network Storage, click **Test** to test the related configuration is correct or not. Once the camera connects to the server successfully, click **Apply**.

### Event Server Setting >> FTP

The screenshot shows the configuration page for the TrendNet Wireless Internet Camera Server (TV-IP422W). The page title is "Event Server Setting » FTP". The interface includes a sidebar with navigation options: Live View, Setup, Smart Wizard, Basic, Network, Pan / Tilt, Video/Audio, Event Server (with sub-options for FTP, Email, and Network Storage), Motion Detect, Event Config, Tools, USB, and Information. The main content area contains the following fields:

FTP	
Host Address:	60.170.180.190
Port Number:	21
User Name:	trendnet
Password:	.....
Directory Path:	/test
Passive mode:	<input checked="" type="checkbox"/> Enable

At the bottom of the form are three buttons: Test, Apply, and Cancel. The footer of the page reads "Copyright © 2007 TRENDnet. All Rights Reserved." The top right corner of the interface displays "Wireless Internet Camera Server TV-IP422W" and "Location: Office1 2008/04/04 14:05:12".

- **Host Address:** Enter the FTP server IP address.
- **Port Number:** Enter the FTP port number.
- **User Name:** Enter the user name to login into the FTP server.



- **Password:** Enter the password to login into the FTP server.
- **Directory Path:** Enter the destination folder for uploading the images. For example, **/Test**.
- **Passive Mode:** Select the **Enable** option to enable passive mode.

## Event Server Setting >> Email

The screenshot shows the Trendnet web interface for a Wireless Internet Camera Server (TV-IP422W). The page title is "Event Server Setting >> Email". The interface includes a sidebar with navigation options: Live View, Setup, Smart Wizard, Basic, Network, Pan / Tilt, Video/Audio, Event Server (with sub-items FTP, Email, and Network Storage), Motion Detect, Event Config, Tools, USB, and Information. The main content area contains the following configuration fields:

Email	
SMTP Server Address:	mailserver.com
Sender Email Address:	joe@mailserver.com
Authentication Mode:	<input type="radio"/> None <input checked="" type="radio"/> SMTP
Sender User Name:	joe
Sender Password:	••••••••
Receiver #1 Email Address:	lisa@mailserver.com
Receiver #2 Email Address:	andy@mailserver.com

At the bottom of the configuration area are three buttons: Test, Apply, and Cancel.

Copyright © 2007 TRENDnet. All Rights Reserved.

- **SMTP Server Address:** Enter the mail server address.
- **Sender Email Address:** Enter the email address of the user who will send the email.
- **Sender User Name:** Enter the user name to login the mail server.
- **Sender Password:** Enter the password to login the mail server.
- **Receiver #1 Email Address:** Enter the first email address of the user who will receive the email.
- **Receiver #2 Email Address:** Enter the second email address of the user who will receive the email.

## Event Server Setting >> Network Storage

The screenshot shows the 'Event Server Setting >> Network Storage' configuration page. The interface includes a sidebar with navigation buttons: Live View, Setup, Smart Wizard, Basic, Network, Pan / Tilt, Video/Audio, Event Server (with sub-items FTP, Email, Network Storage), Motion Detect, Event Config, Tools, USB, and Information. The main content area is titled 'Event Server Setting » Network Storage' and contains the following fields:

Network Storage	
Samba Server Address:	<input type="text"/>
Share:	<input type="text"/>
Path:	<input type="text"/>
User Name:	<input type="text"/> <input checked="" type="checkbox"/> Anonymous
Password:	<input type="text"/>
Split By:	<input checked="" type="radio"/> File Size <input type="text" value="100"/> (MB) <input type="radio"/> Recording Time <input type="text" value="30"/> (Minutes)
When Disk Full:	<input type="radio"/> Stop Recording <input checked="" type="radio"/> Recycle - Delete Oldest Folder

At the bottom of the configuration area are three buttons: Test, Apply, and Cancel.

Copyright © 2007 TRENDnet. All Rights Reserved.

- **Samba Server Address:** Enter the IP address of the Network Storage server.
- **Share:** Assign the folder on the Network Storage server to share the files to users.
- **Path:** Assign the path for uploading the files on the Network Storage server. For example, */Test/*.
- **User Name:** Enter the user name to login into the Network Storage server.
- **Password:** Enter the password to login into the Network Storage server.
- **Split By:** When the file is too large to upload smoothly, use this option to split it by selecting **File Size** or **Recording Time**.

- **When Disk Full:** Select **Stop Recording** or **Recycle – Delete Oldest Folder of File** when the storage space on the Network Storage server is full.

## 4.8 Motion Detect

The Motion Detect menu contains the command and option that allow you to enable and set up the motion detection feature of the camera. The camera provides two detecting areas.

To enable the detecting area, select **Window 1** or **2** from the pull-down list, and then select **Enable**. When the detecting area is enabled, you can use the mouse to move the detecting area and change the area coverage.

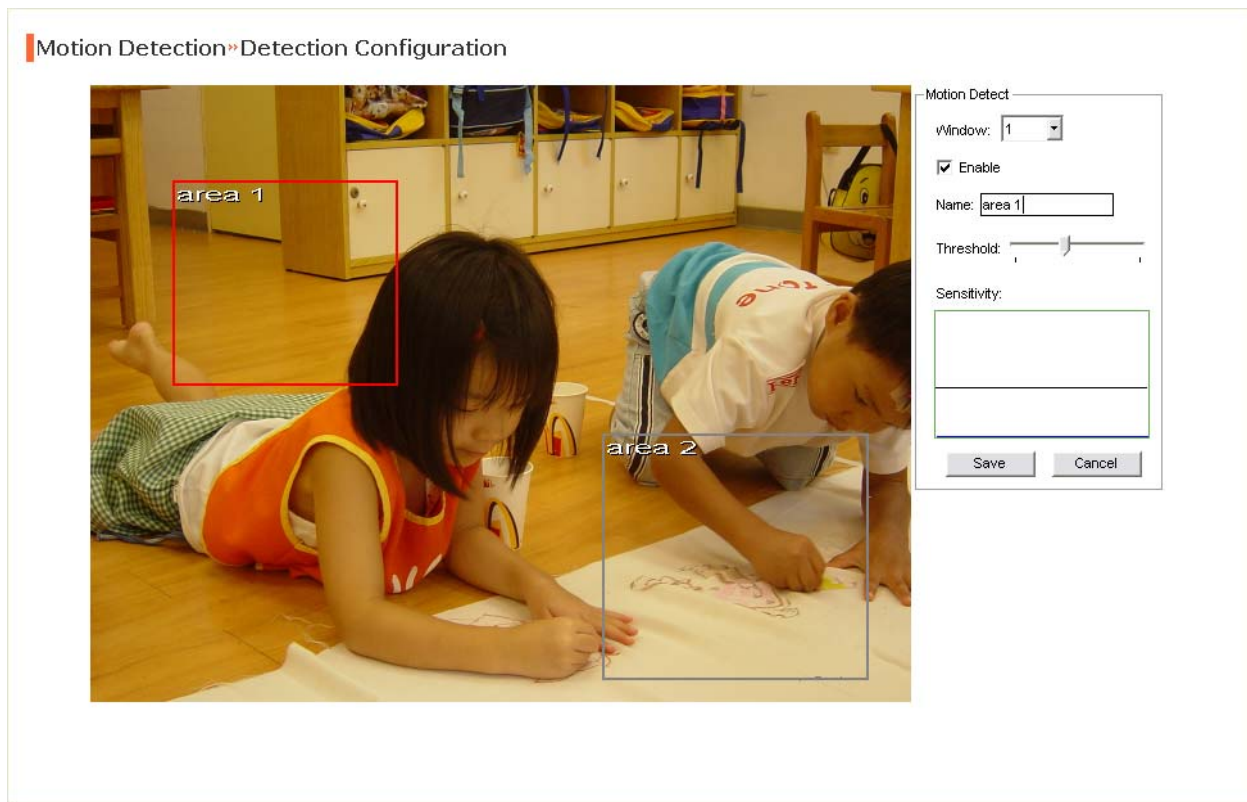

- **Name:** Assign a name to the detecting area.
- **Threshold:** Move the slide bar to adjust the level for detecting motion to record video.

**NOTE** Sliding the Threshold bar to the right will decrease the sensitivity of motion detection; sliding the Threshold bar to the left will increase the sensitivity of motion detection

## 4.9 Event Config

The Event Config menu contains five sub-menus that provide the commands to configure event profiles.

### Event Configuration >> General Setting

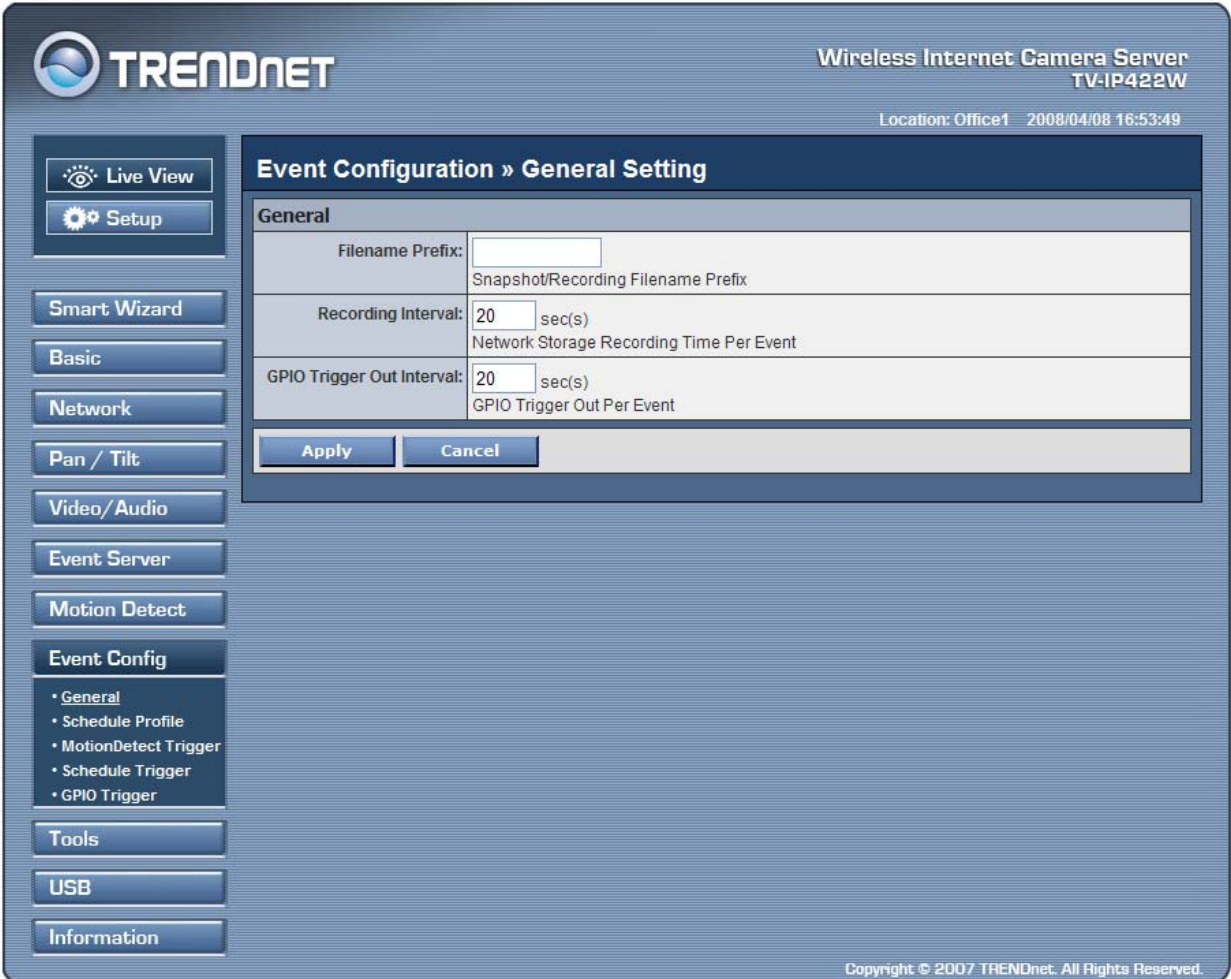

The screenshot displays the Trendnet web interface for a Wireless Internet Camera Server (TV-IP422W). The page title is "Event Configuration >> General Setting". The interface includes a sidebar with navigation buttons: Live View, Setup, Smart Wizard, Basic, Network, Pan / Tilt, Video / Audio, Event Server, Motion Detect, Event Config (with sub-items: General, Schedule Profile, MotionDetect Trigger, Schedule Trigger, GPIO Trigger), Tools, USB, and Information. The main content area shows the "General" settings for the Event Configuration. The settings are as follows:

General	
Filename Prefix:	<input type="text"/> Snapshot/Recording Filename Prefix
Recording Interval:	20 sec(s) Network Storage Recording Time Per Event
GPIO Trigger Out Interval:	20 sec(s) GPIO Trigger Out Per Event

At the bottom of the settings area, there are "Apply" and "Cancel" buttons. The footer of the page reads "Copyright © 2007 TRENDnet. All Rights Reserved."

- **Snapshot/Recording Subfolder:** You can assign a descriptive name for the subfolder to save the captured image/video files. Otherwise, leave this option blank to use the default setting.

- **Network Storage Recording Time Per Event:** Limit the recording time while you are using the Network Storage solution.
- **GPIO Trigger Out Retention Time Per Event:** Limit the retention time of the GPIO Trigger Out function.

## Event Configuration >> Arrange Schedule Profile

This sub-menu displays the scheduled profile(s). To customize the profile, click **Add** and then enter a descriptive name for the profile in the prompt dialog window. After entering the profile name, click **OK** and the profile is added to the Schedule Profiles list. To delete the profile, select the profile in the list and click **Delete**.

The screenshot displays the 'Event Configuration >> Arrange Schedule Profile' interface. On the left sidebar, the 'Event Config' menu is expanded, showing options for General, Schedule Profile, MotionDetect Trigger, Schedule Trigger, and GPIO Trigger. The main area shows a 'Schedule Profile' list with 'Office 1' selected. Below the list, the configuration for 'Office 1' is shown: Profile Name is 'Office 1', Weekdays are set to Sun, and the Time List includes '09:00 - 12:00' and '13:00 - 17:00'. The Start Time is 13:00 and the End Time is 17:00. Buttons for 'Add', 'Delete', 'Copy this to all weekdays', and 'Delete this from all weekdays' are available. The interface is titled 'TRENDNET Wireless Internet Camera Server TV-IP422W' and shows the location 'Office1' and date/time '2008/04/08 16:58:16'.

- **Profile Name:** Display the profile name that you select in the Schedule Profiles list.
- **Weekdays:** Select the weekday(s) that you want to separately assign in the schedule profile. The weekday that has been assigned will be displayed with green color.
- **Time List:** Display the time period that you have assigned within the selected weekday. To assign the same time period to every weekday, click **Add this to all weekdays**; click **Delete this from all weekdays** to remove the selected time period from every weekday. Click Delete to remove the selected time period.
- **Start/End Time:** Enter the start and end time and then click **Add** to assign a time period within in the selected weekday.

## **Event Configuration >> Motion Detect Trigger**

Select the **Enable** option to enable the motion detect trigger function of the camera, so that you can set Trigger Out function or send captured images within the detecting area to the FTP server, email receiver, Network Storage server, or the connected USB device. You have to configure corresponding settings, such as FTP server and email server, to enable this feature.



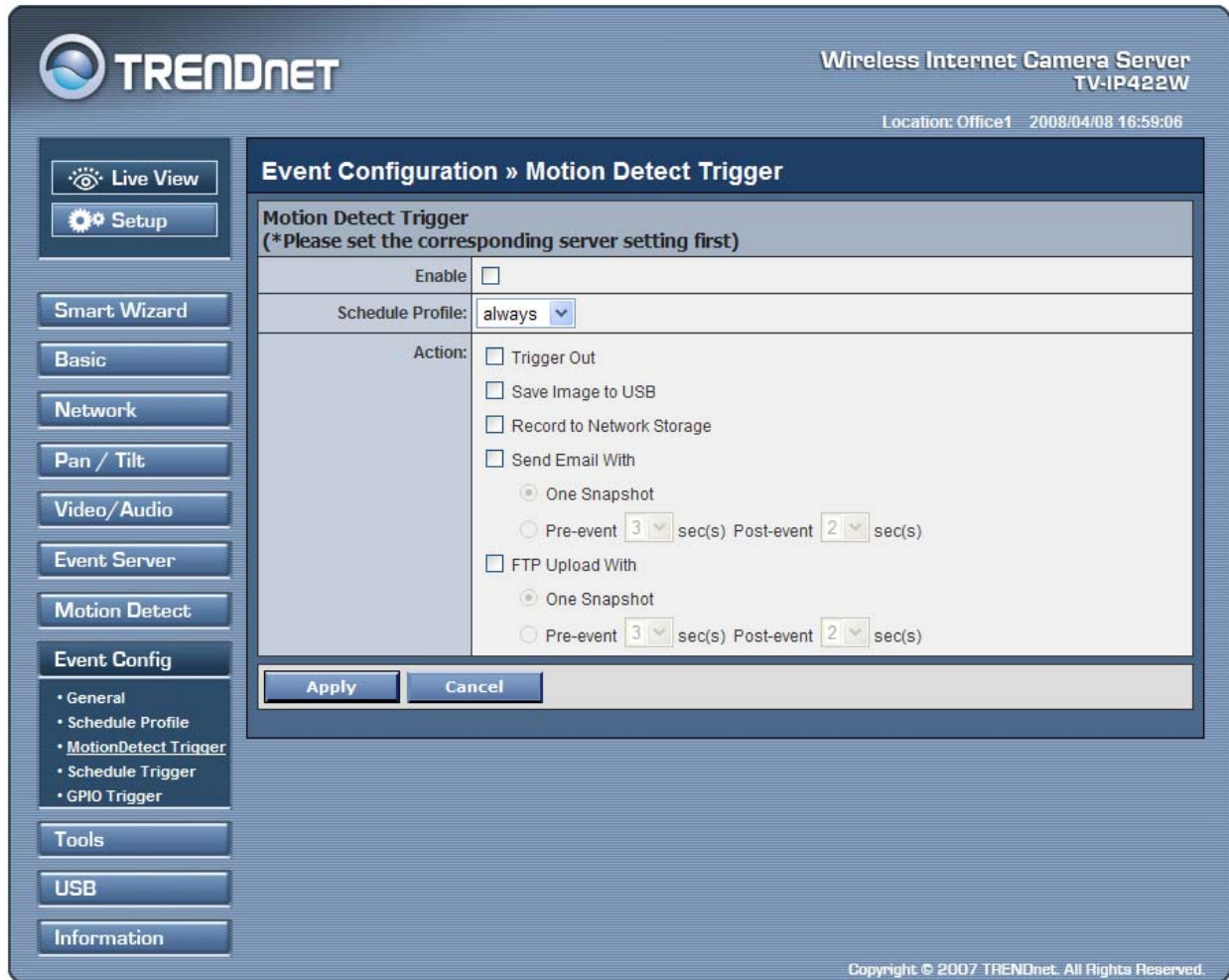

- **Schedule Profile:** Select a schedule profile from the pull-down list.
- **Action:** Set the **Trigger Out** function or select the destination of the captured images: **Save Image to USB, Record to Network Storage, Send Email, or FTP Upload.**

**NOTE** Setting the Pre-event/Post-event time for sending email or uploading to FTP may cause the system overloads.

## Event Configuration >> Schedule Trigger

You can separately configure the schedule for trigger function of the camera by **Email, FTP, or Network Storage**. Select the **Enable** option on each item, and then select a **Schedule Profile** from the pull-down list and set the **Interval** time.



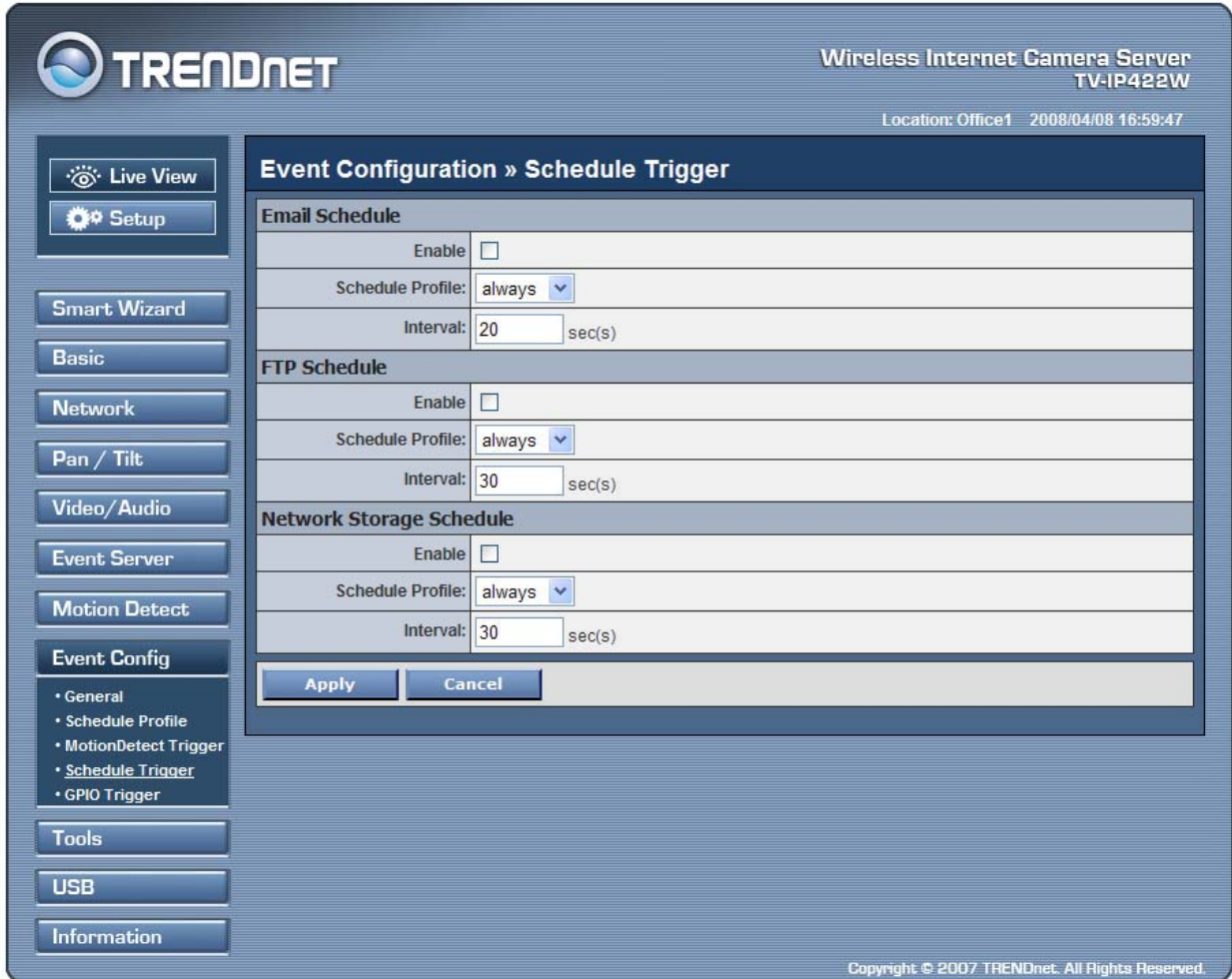

**NOTE** If the setting value of the **Network Storage Recording Time Per Event** option in General Setting is longer than the **Interval** time in Network Storage Schedule, the recorded file will be a continuous video clip.

For example, if you set the **Network Storage Recording Time Per Event** as 10 seconds and the **Interval** as 5 seconds, recorded file becomes a non-stop video clip because the camera will record a 10-second video clip every 5 seconds.

## Event Configuration >> GPIO Trigger

Select the **Enable** option to enable the GPIO trigger function of the camera, so that you can set Trigger Out function or send captured images within the detecting area to the FTP server, email receiver, Network

Storage server, or the connected USB device. You have to configure corresponding settings, such as FTP server and email server, to enable this feature.

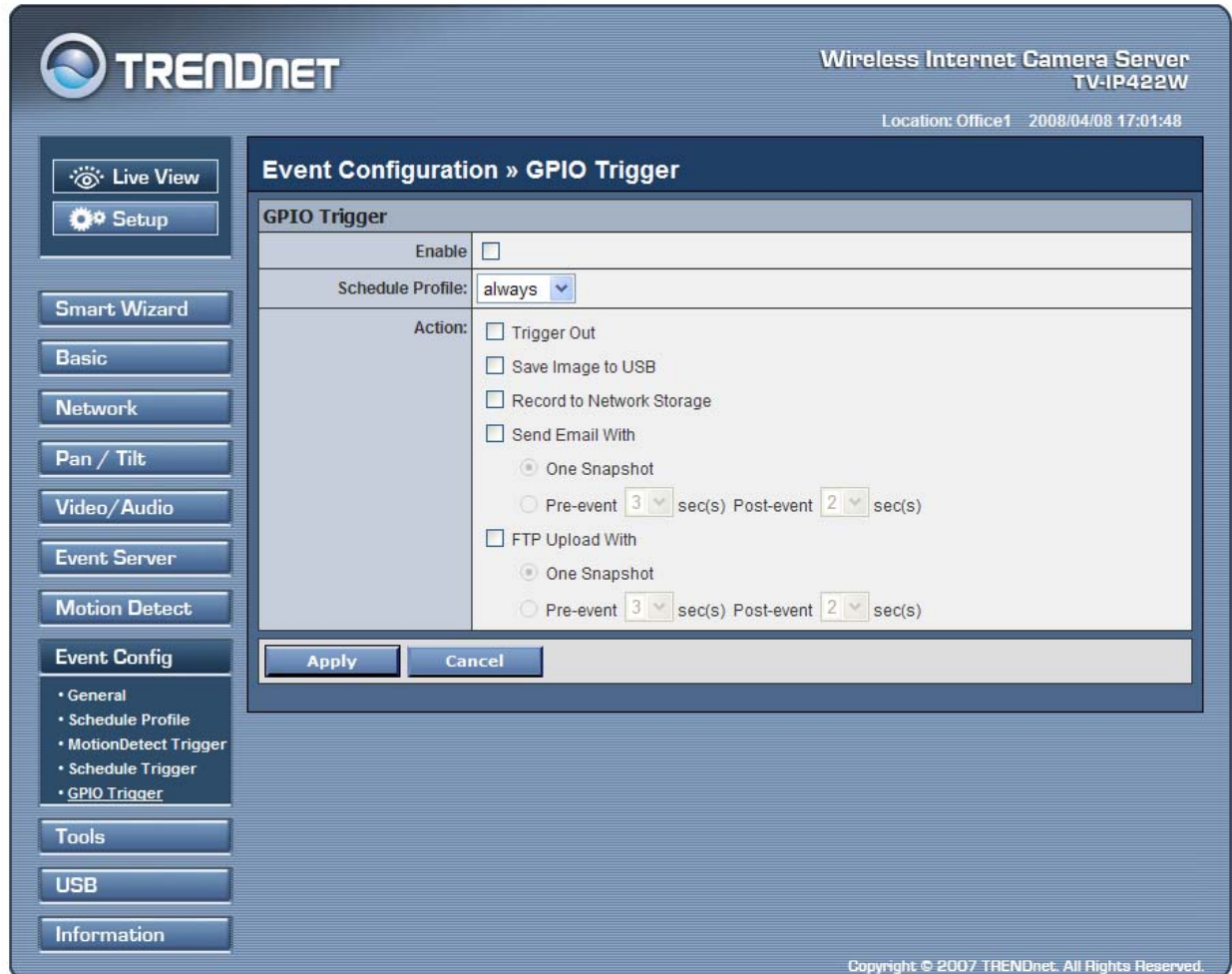

- **Schedule Profile:** Select a schedule profile from the pull-down list.
- **Action:** Set the **Trigger Out** function or select the destination of the captured images: **Save Image to USB, Record to Network, Storage, Send Email, or FTP Upload.**

**NOTE** Setting the Pre-event/Post-event time for sending email or uploading to FTP may cause the system overloads.

## 4.10 Tools

The Tools menu provides the commands that allow you to restart or reset the camera. You can also backup and restore your configuration, and upgrade the firmware for the camera.

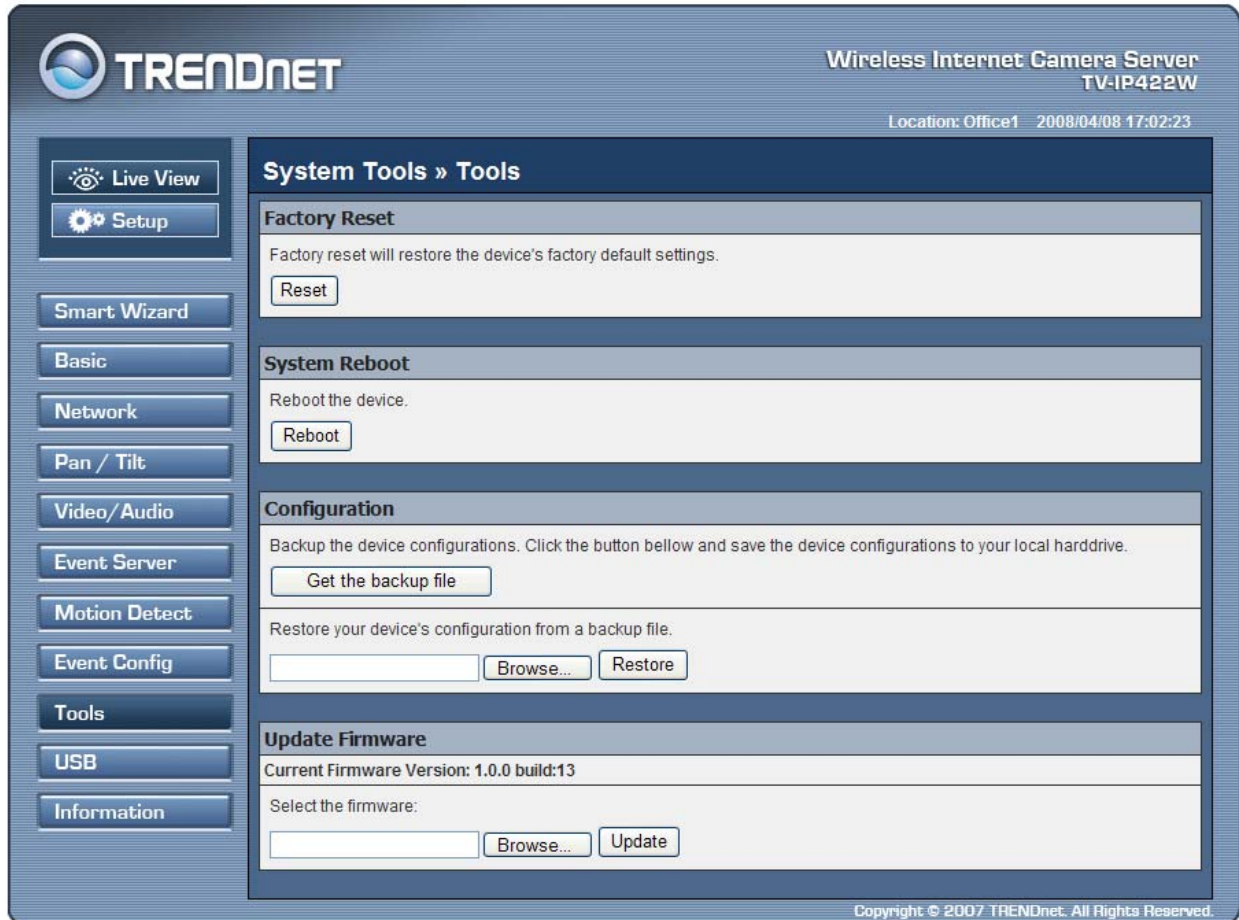

### ■ Factory Reset

Click **Reset** to restore all factory default settings for the camera.

### ■ System Reboot

Click **Reboot** to restart the camera just like turning the device off and on. The camera configuration will be retained after rebooting.

### ■ Configuration

You can save your camera configuration as a backup file on your computer. Whenever you want to resume the original settings, you can restore them by retrieving the backup file.

- **Backup:** Click **Get the backup file** to save the current configuration of the camera.
- **Restore:** Click **Browse** to locate the backup file and then click **Restore**.

## ■ **Update Firmware**

This item displays the current firmware version. You can upgrade the firmware for your camera once you obtained a latest version of firmware.

- **Select the firmware:** Click **Browse** to locate the backup file (.pck) and then click **Update**.

**NOTE** Make sure to keep the camera connected to the power source during the process of upgrading firmware. Otherwise, the camera might be damaged because of failure of upgrading firmware.

## 4.11 USB

The USB menu provides the information and controls of the connected USB device.



### ■ USB Dismount

To safely remove the connected USB device, you can press the Unmount button for four seconds on the camera or click **Dismount** from this item.

### ■ USB Information

Display the **Total space** and **Free space** of the USB device.

### ■ USB Setting

- **When Disk Full:** Select **Stop Recording** or **Recycle – Delete Oldest Folder of File** when the storage space on the USB device is full.

**NOTE** The connected USB storage device can be used to store still images only and as your host system backup. It is not recommended to use the USB device as your major storage device.

## 4.12 Information

The Information menu displays the current configuration and events log of the camera.

**TRENDnet** Wireless Internet Camera Server  
TV-IP422W  
Location: Office1 2008/04/16 13:10:03

**System Information » Device Information**

Basic	
Camera Name:	TV-IP422W
Location:	Office1
Firmware Version:	1.0.0 build: 17
Video & Audio	
MPEG4 Resolution:	VGA
MJPEG Resolution:	VGA
3GPP Enable:	Disable
Microphone In:	Enable
Speaker Out:	Enable
Network	
IP MODE:	DHCP
IP Address:	192.168.1.76
Subnet Mask:	255.255.255.0
Default Gateway:	192.168.1.254
MAC Address:	00:1A:97:00:1A:DD
Primary DNS Address:	192.168.1.245
Secondary DNS address:	
UPnP Enable:	Enable
HTTP Port:	80
RTSP Port:	554
Wireless	
ESSID:	TRENDnet
Connection:	Infrastructure
Channel:	Not Connected
Authentication:	Open
Encryption:	None

Copyright © 2007 TRENDnet. All Rights Reserved.

### ■ Device Info

Display the Basic, Video & Audio, Network, and Wireless settings of the camera.

### ■ System Log

The Logs table displays the events log recorded by the system.



# CHAPTER 5

---

## SECURVIEW™ SOFTWARE

This Chapter describes detail instructions on operating SecurView™ software, a useful friendly application for ease of control and navigation requirement.

### 5.1 INSTALLATION

1. Insert the Installation CD-ROM into your computer's CD-ROM drive to initiate the Auto-Run program.
2. Click the **SecurView** from the Auto-Run menu screen.



**NOTE** To use SecurView™, you must have Microsoft .NET Framework 2.0 installed in the computer. The setup wizard will detect it and, if the program is not installed yet, ask you to install it during the process of installing SecurView™.

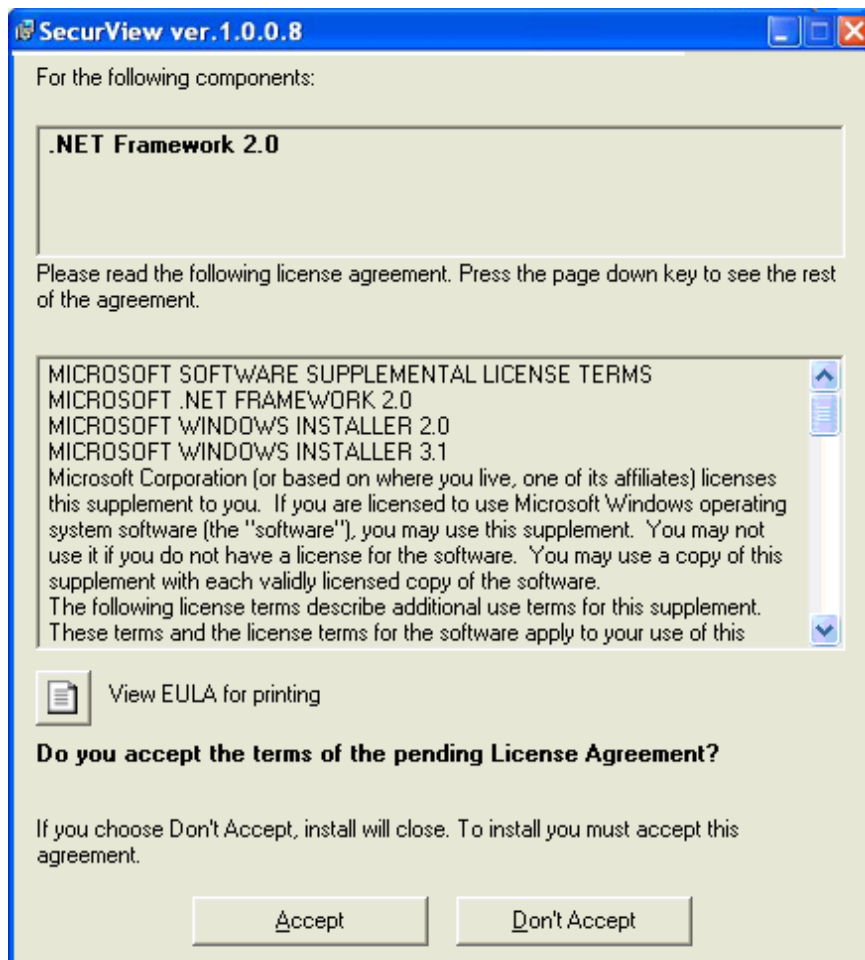

3. Then **SecurView** Setup Wizard will appear. Click "**Next**" when the **Welcome to the SecurView Setup Wizard** appears



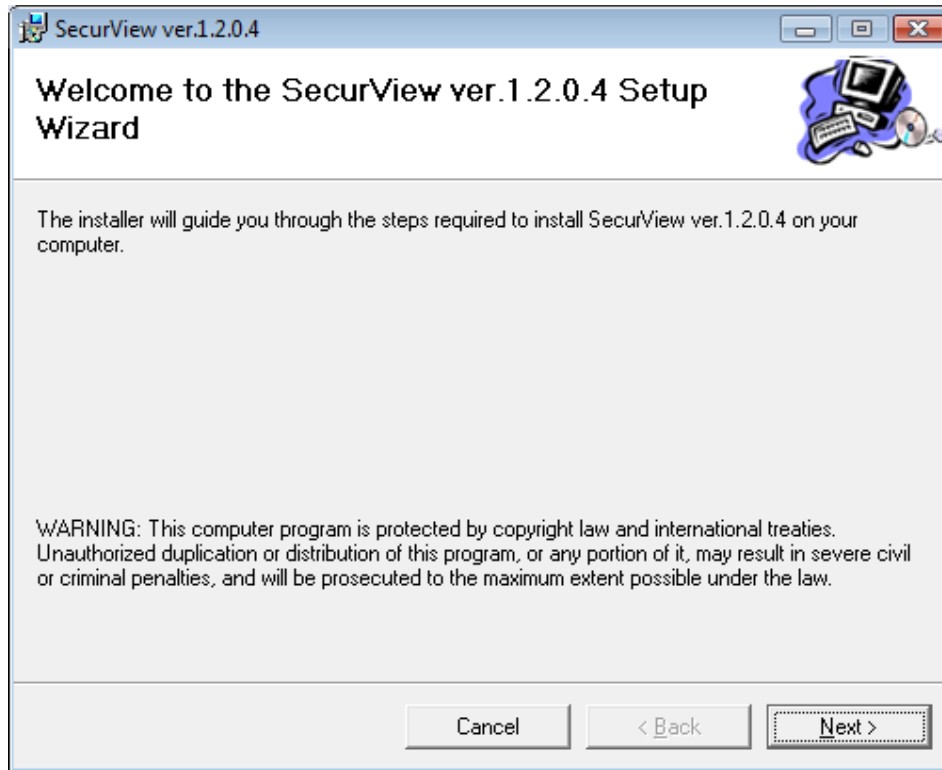

4. Click "**Browse**" to choose the desired destination location. By default, the destination location is C:\Program Files\TRENDnet\SecurView. Then Click "**Next**".

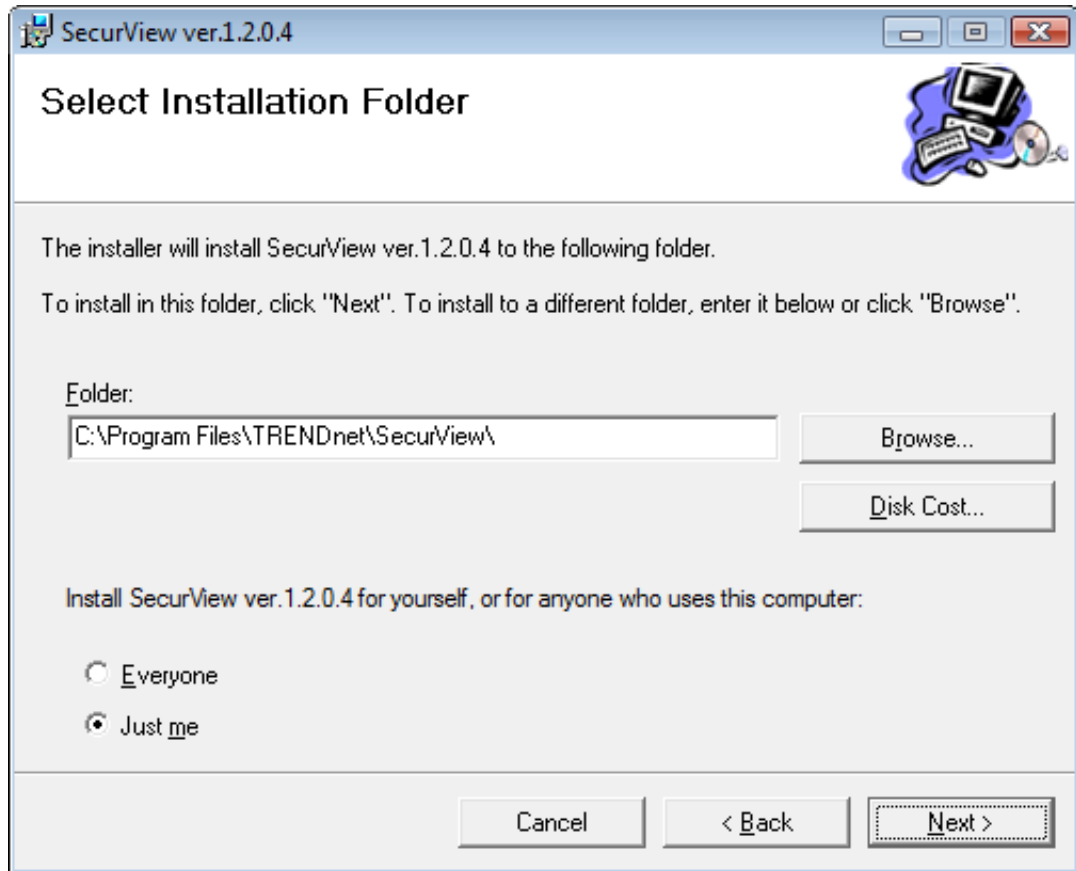

5. Click "**Next**" to confirm the SecurView software to be installed to the computer.

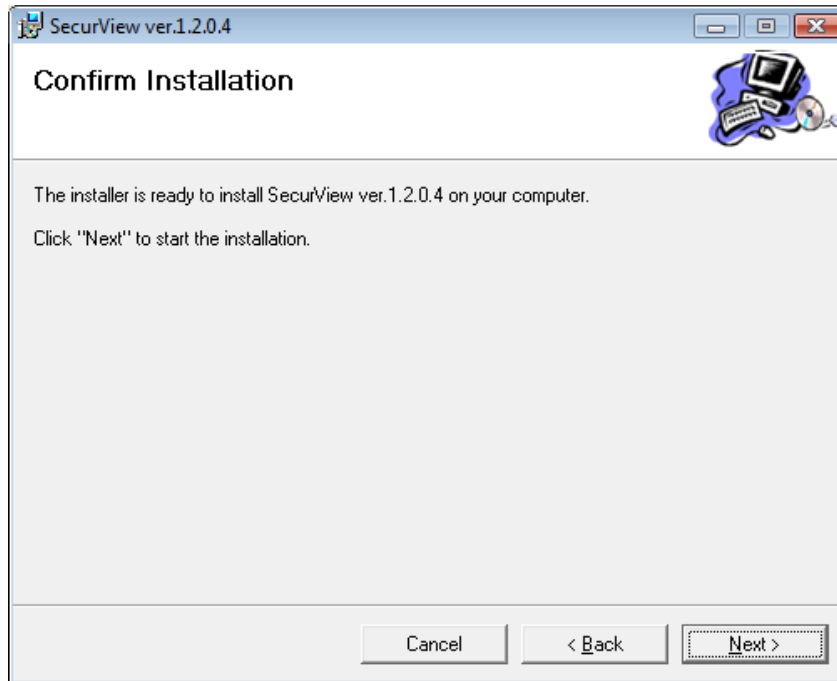

6. Click t When the **Installation Complete** window appears, click **"Close"**.

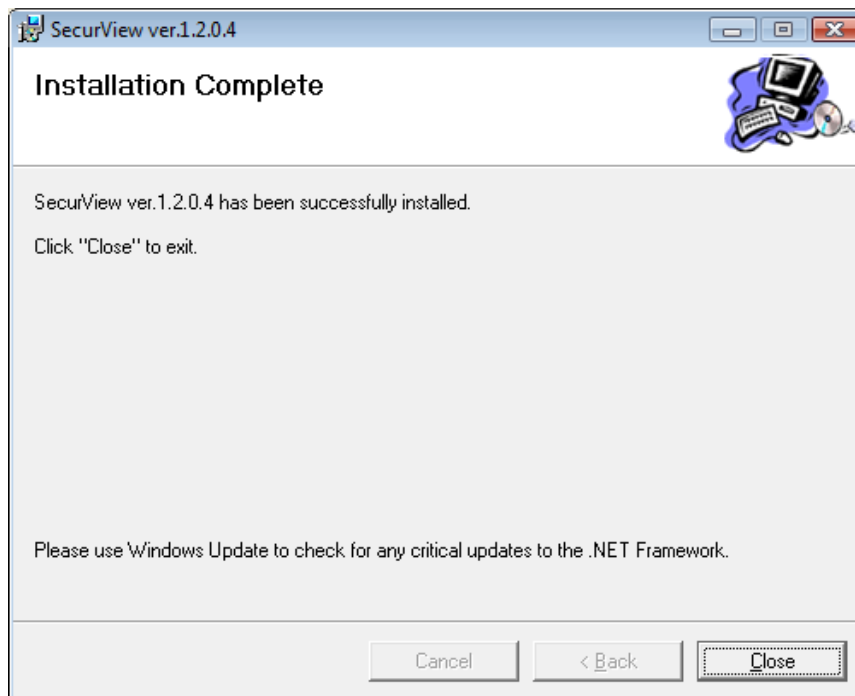

7. After installing the IPSetup utility, the application is automatically installed to your computer, and creates a folder in “ **Start \Program\TRENDnet\SecurView**”.

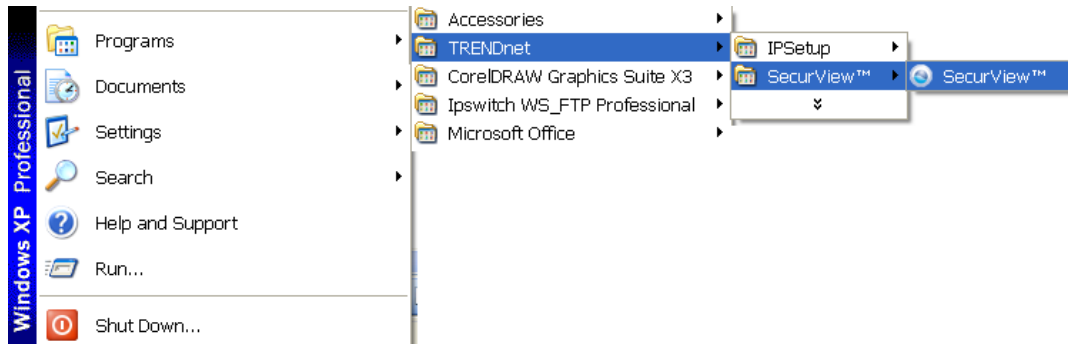

## 5.2 USING INSTALLATION

1. To launch the program, click **Start > Program > TRENDnet > SecurView**, and then click **SecruView™**. The main screen will appear as below.

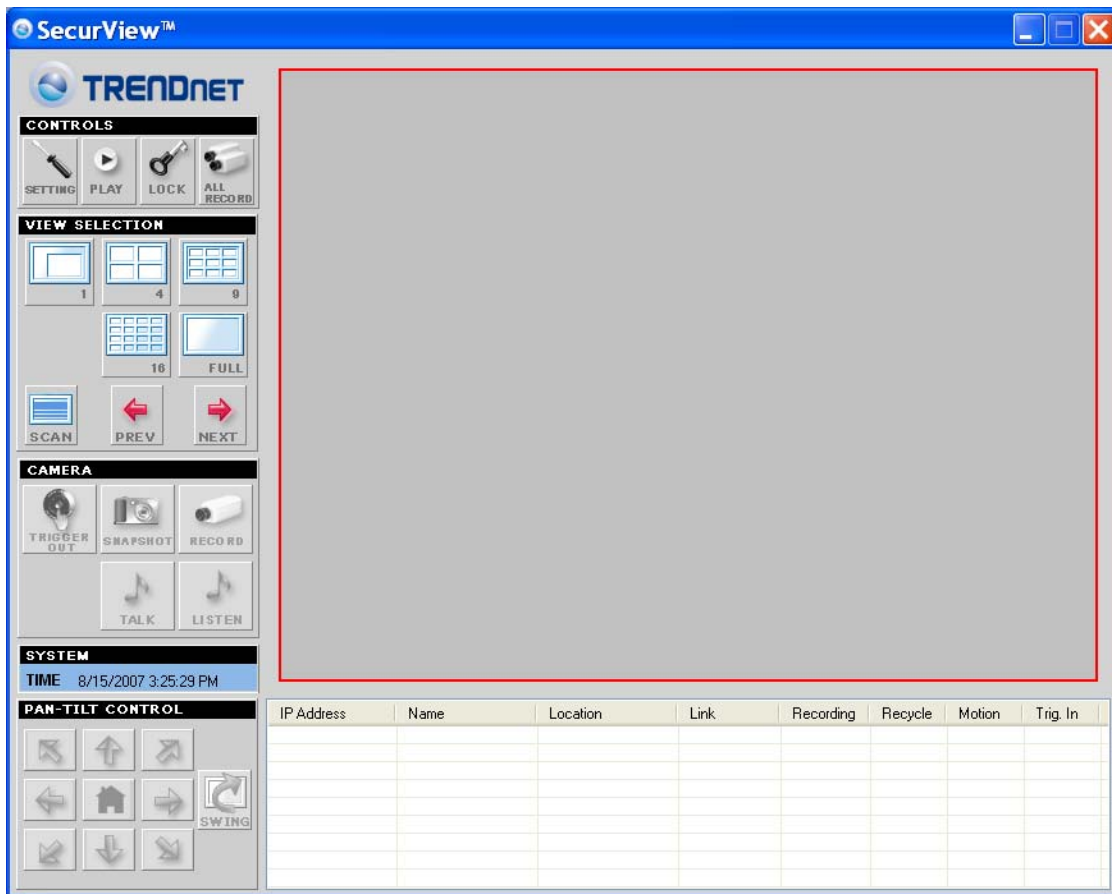

**NOTE** Please set the resolution to 1024x768 or above on your computer while using SecurView™; otherwise, the displayed main screen may be distorted.

## Item features

The following describes the function of each item on the main screen:

- **CONTROLS Panel**



- **SETTING:** Click to enter the Setting screen of SecurView™. Click again to return to the main screen of SecurView™.
- **PLAY:** Click to play the recorded video file using the media player on the computer (for example, Windows Media Player by default).

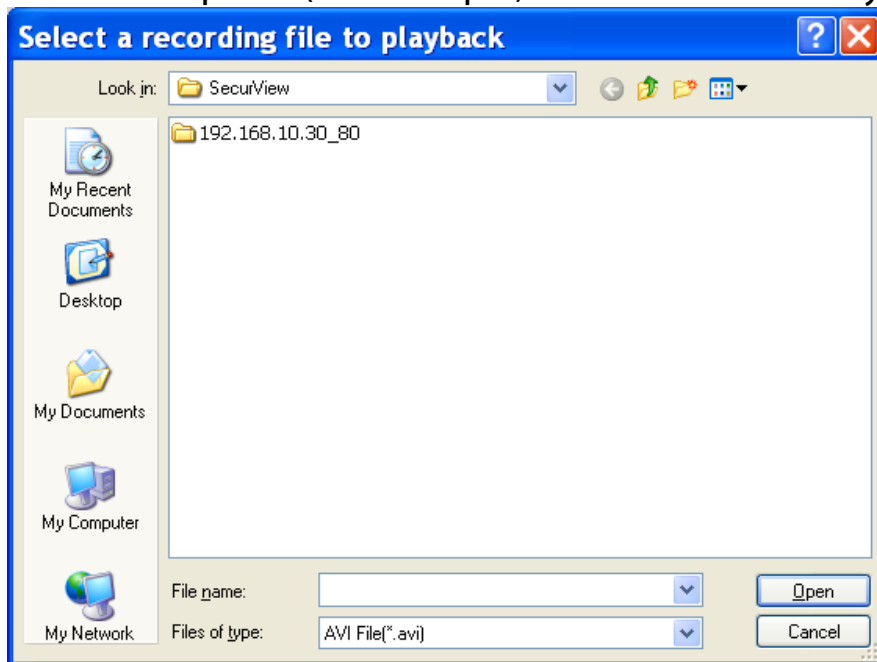

- **LOCK:** Click to lock the camera controls. Click again to resume controls for the camera. If you have set ID and Password in **SETTING > Account**, you will be asked to enter the required information to unlock.

- **ALL RECORD:** Click to start recording video clips using ALL connected cameras. To stop recording, please click Record button  to stop the individual camera. Please note: stop recording only stop the manual recording camera. For schedule recording, please change the setting on configuration.

**TIP** By default, the ID and Password boxes are “blank.” Click **SETTING** > **Account** to change the ID and password of lock/unlock function.

## ■ VIEW SELECTION Panel

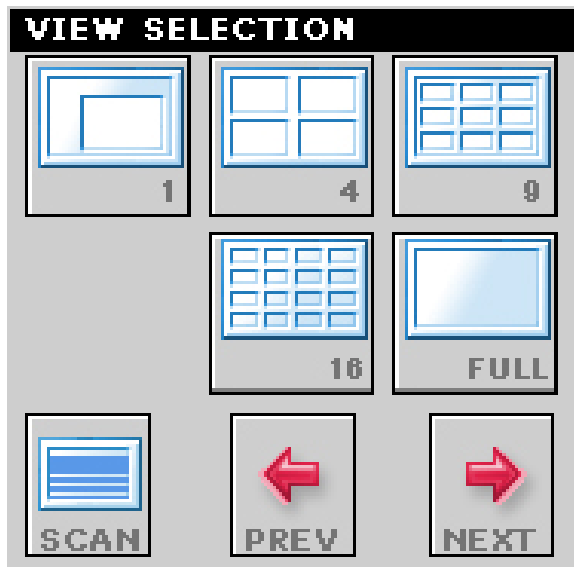

- **View mode buttons:** SecurView™ provides multiple view modes, including 1/4/9/16 windows and Full screen mode.
- **SCAN:** When multiple cameras connected, click this button to display the video views between cameras. Click the Scan button again to stop scanning.
- **PREV:** When multiple cameras connected, click this button to switch the video view to the previous camera.
- **NEXT:** When multiple cameras connected, click this button to switch the video view to the next camera.

**TIP** To set the time interval of scanning, click **SETTING > Other** and then adjust the time from 1 to 10 seconds in the **Time interval of scan** option.



## ■ CAMERA Panel



- **TRIGGER OUT:** Click to turn on the trigger out connector of the camera. This button is available only when the connected camera supports the trigger out connector, which is used to control the external device connected to the camera, such as a light.
- **SNAPSHOT:** Click to capture a still image using the selected camera and save the file in the computer.
- **RECORD:** Click to start recording a video clip using the selected camera. Click again to stop recording and save the file in the computer.
- **TALK:** Click to speak out through the camera. Please note only one user is allowed to use this function at the same time.
- **LISTEN:** Click to receive the on-site sound and voice from the camera.

## ■ SYSTEM Panel

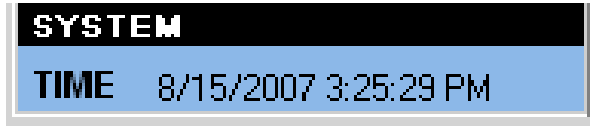





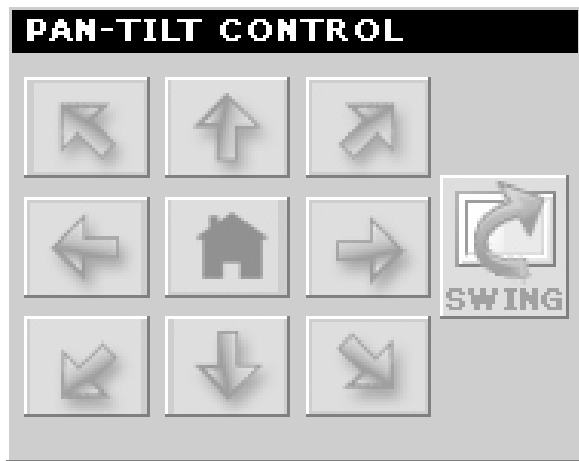



This panel displays the current date and time.

## ■ PAN-TILT CONTROL Panel



When you connect a pan/tilt camera, the system will detect the camera's function automatically and the PAN-TILT CONTROL buttons will become functional. Otherwise, these buttons are displayed as gray out buttons.

- **Direction/Home buttons:** Click these buttons to adjust the camera's viewing angle to Up (  ) / Down (  ) / Left (  ) / Right (  ) / Left-Up (  ) / Left-Down (  ) / Right-Up (  ) / Right-Down (  ).

Click the **Home** button (  ) to return the camera to the default position.

- **SWING:** If you have saved two or more positions for the selected camera, click this button to control the camera swinging from one position to another position.

## ■ Video View Window and Camera List

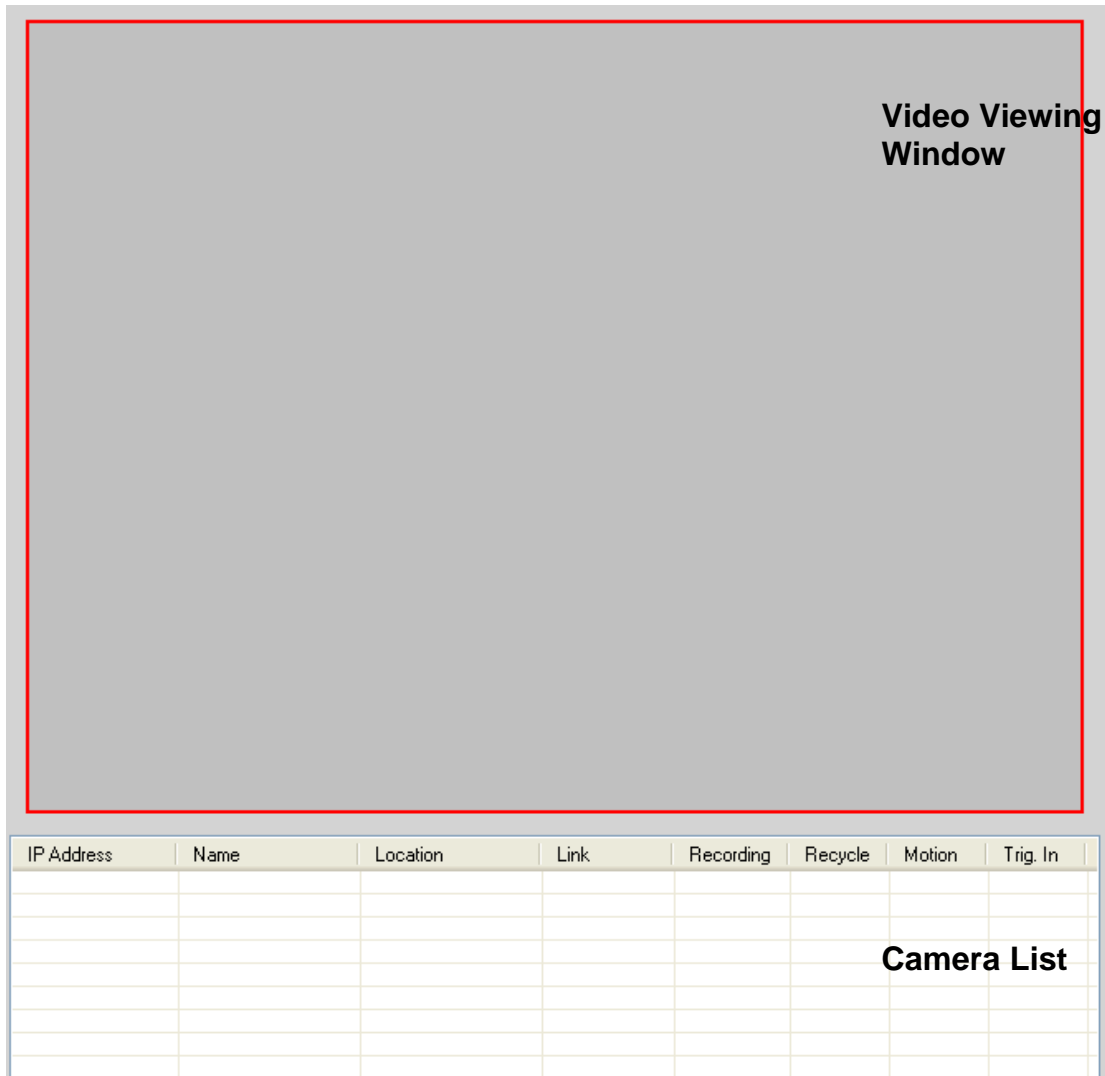

- **Video Viewing Window:** This window displays the video view of the selected camera, which can be divided into 4/9/16 windows according to your selection in VIEW SELECTION panel.
- **Camera List:** This list displays the information of the connected camera(s).

# To add a camera

- 1. Click **SETTING** in the CONTROLS panel to display the Setting screen.
- 2. Click **Add New Camera**.

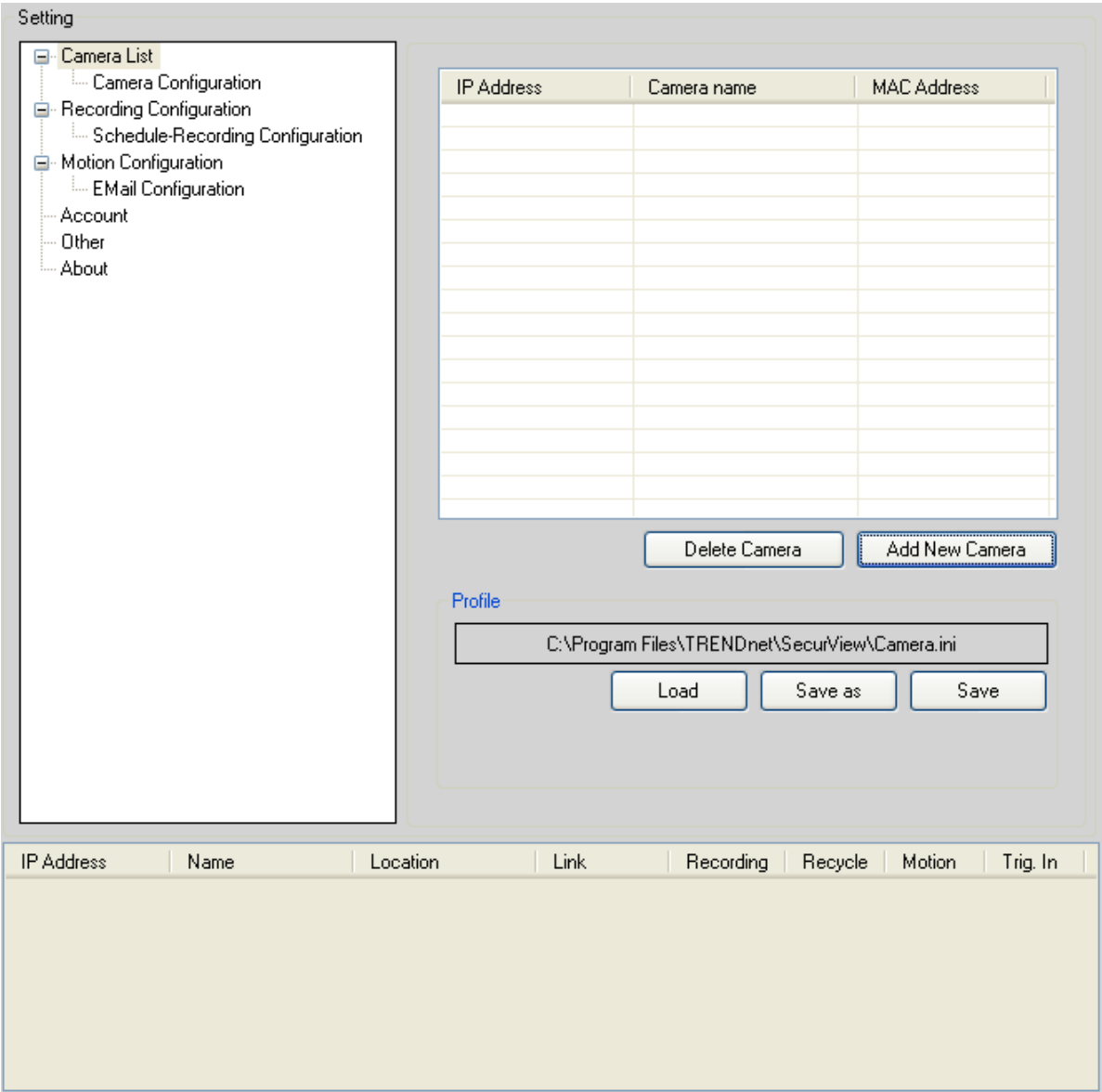

3. In the pop-up Add New Camera dialog window, you can:
- Select the **Search** tab if you are not sure of the camera's IP address. Click **Search camera** to search the available camera within the network. Once the camera is found and is shown in the list, select it and click **Add Camera**.

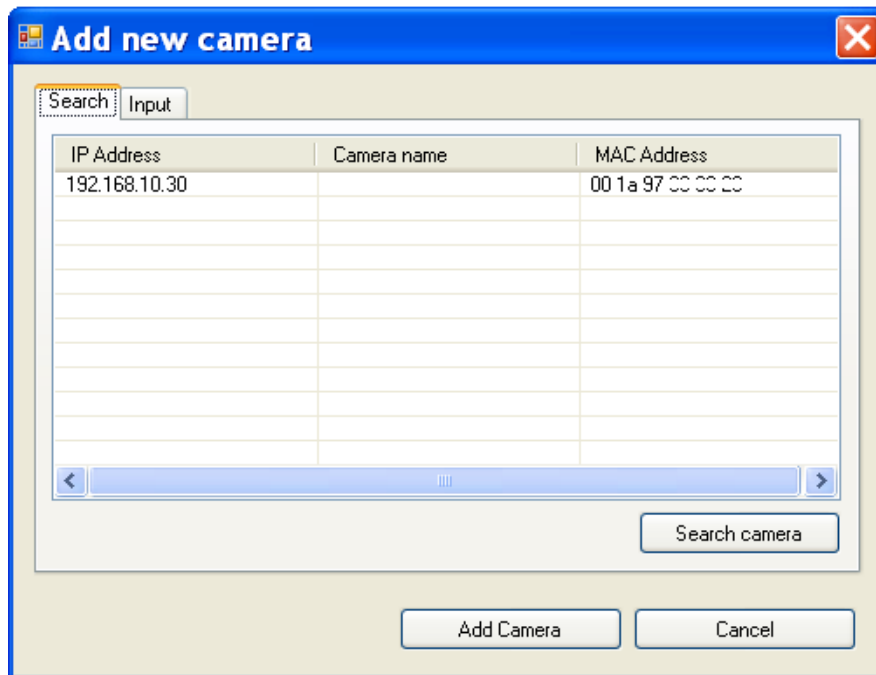

- Select the **Input** tab to add a camera by entering its IP address directly. Enter the camera's IP address and Port (default: **80**), and then click **Add Camera**.

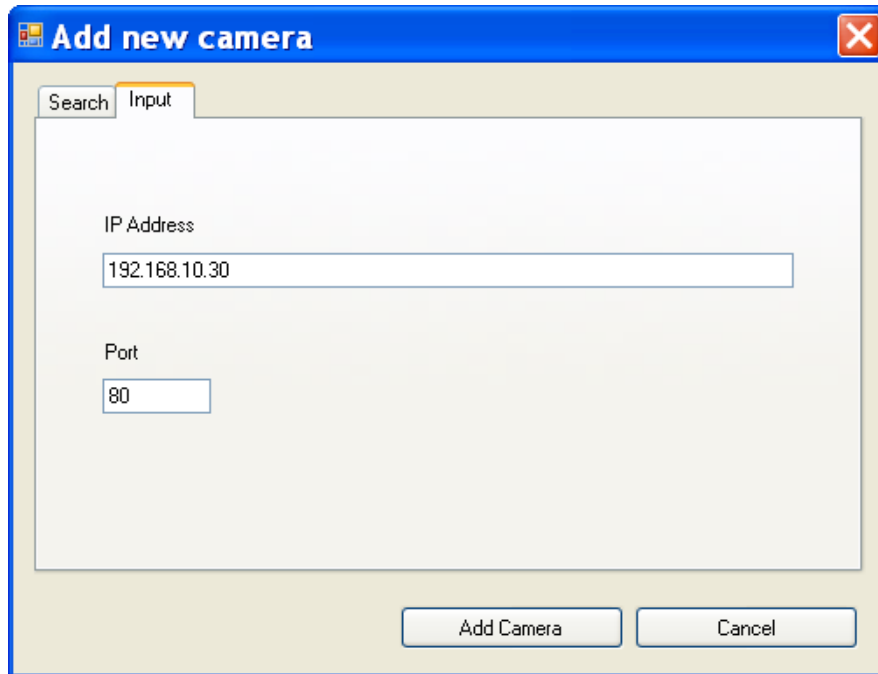

4. Enter the User name and Password for the camera, and then click **OK**. The connected camera will be displayed in the Camera List.

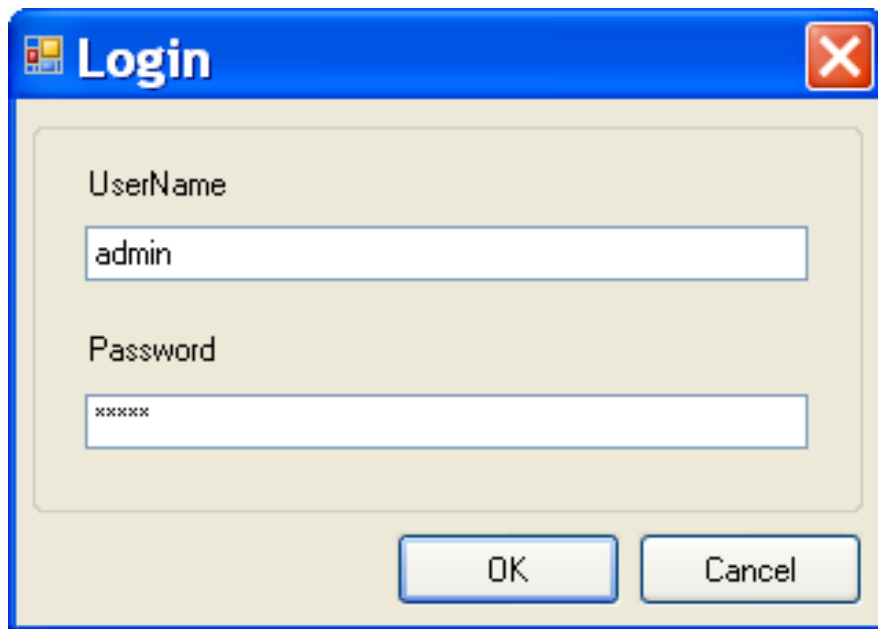

5. Click **SETTING** to return to the Video View Window. The video view of the selected camera will be displayed now.

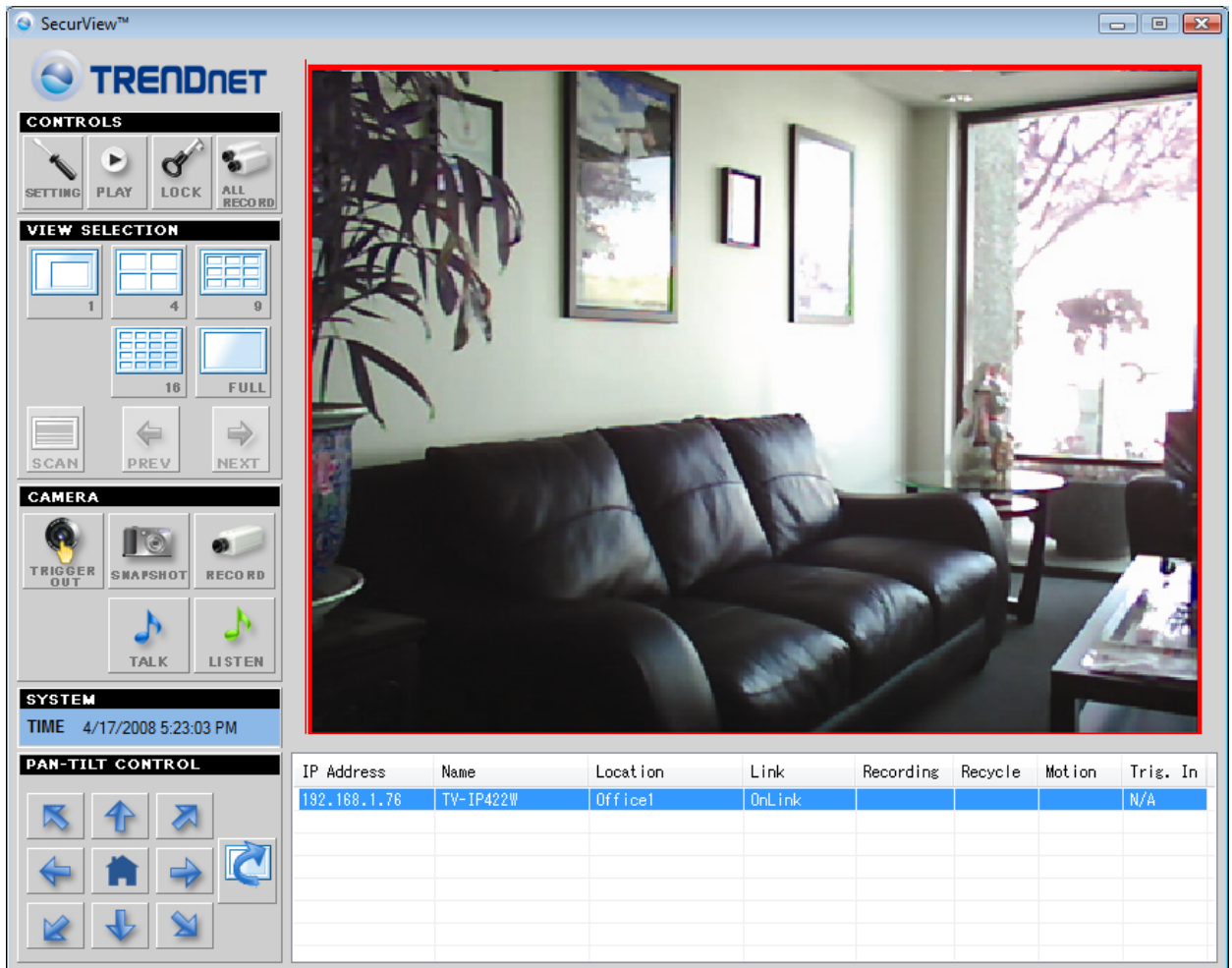

## To remove a camera

1. Click **SETTING** in the CONTROLS panel to display the Setting screen.
2. Select a camera from the list and click **Delete Camera**.

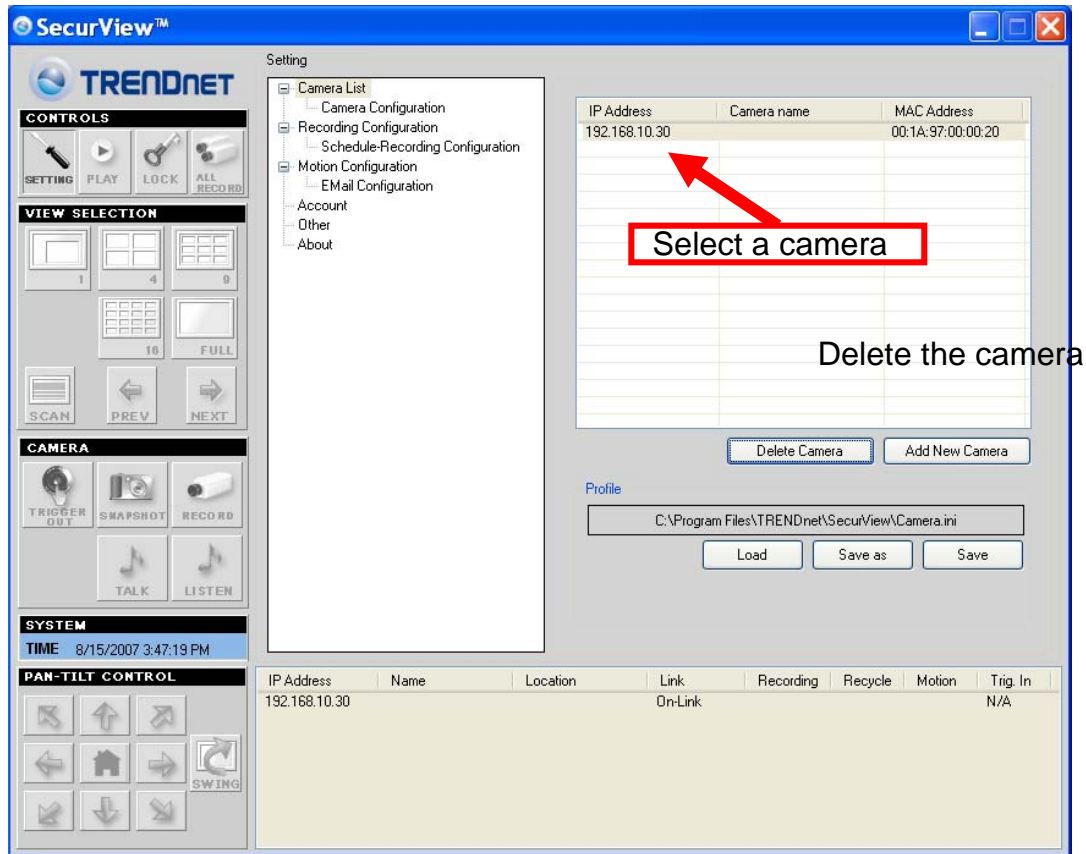

## To link to the Web page of the camera

Click **SETTING** > **Camera List** > **Camera Configuration** and then **Link web page** to launch the Web browser that displays live view image and Web Configuration of the selected camera.



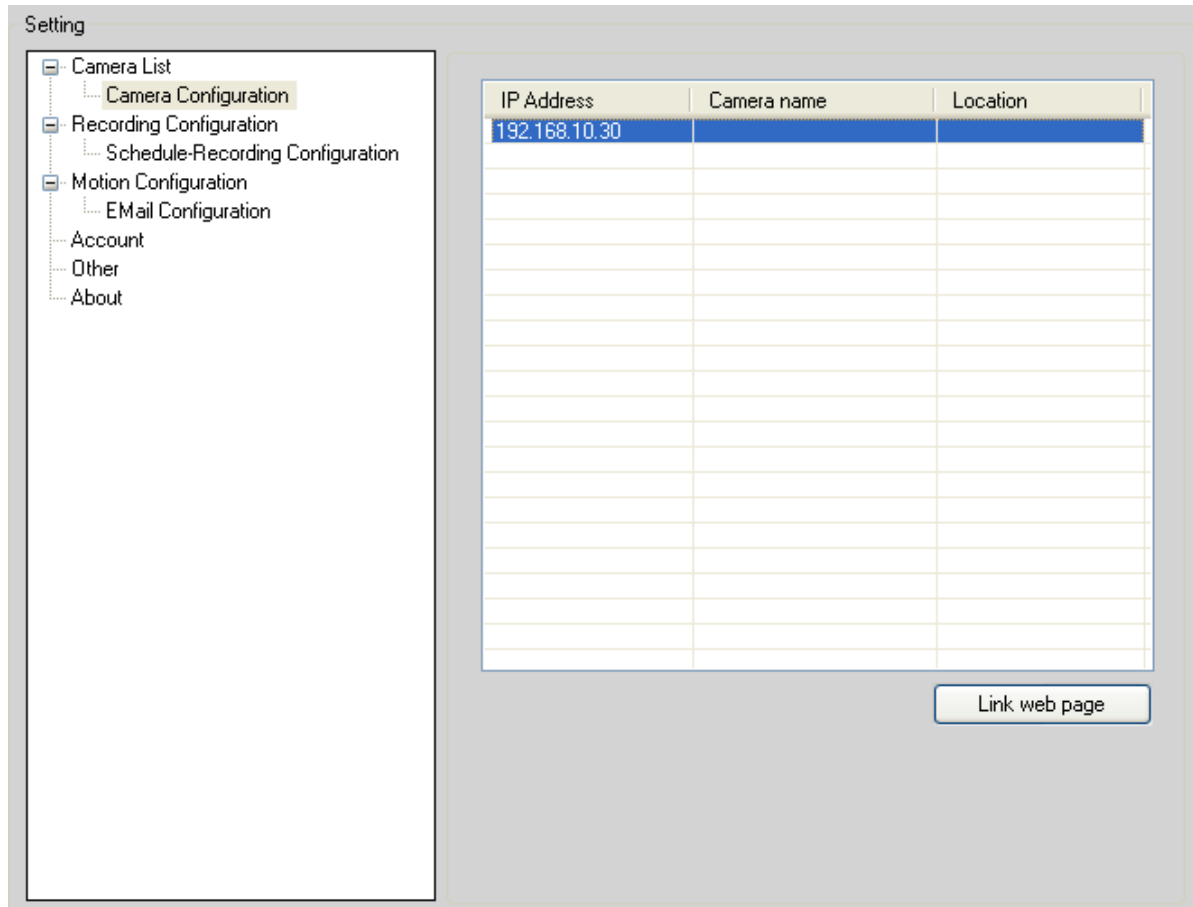

## To record video

SecurView™ provides three methods to record video clips: one is to click the **RECORD/All Record** button to record manually; the second is to record by motion detection; the third is to set the recording schedule in **Setting > Recording Configuration > Schedule Recording Configuration**.

- **Manually recording**

Click **RECORD/All Record** and it starts recording. Click the button again to stop.

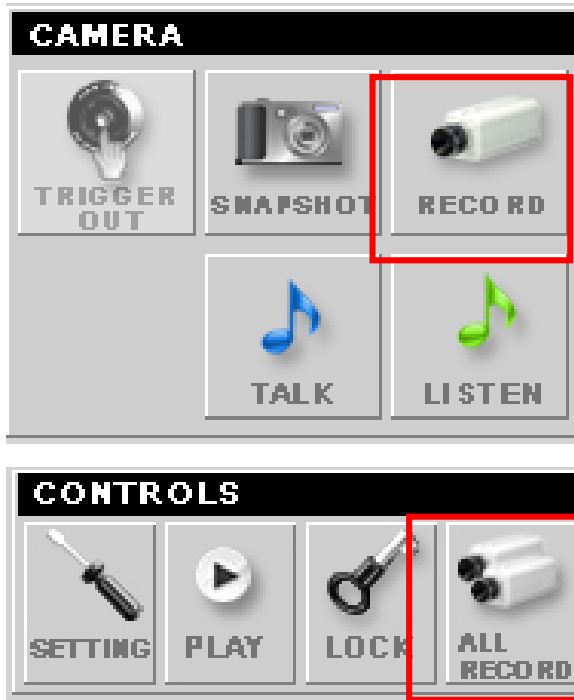

- **Trigger recording by motion detection**

When the motion detection function of the selected camera is enabled, you can configure the camera to start recording triggered by the motion detected. Click **SETTING > Motion Configuration**, and then select the **Recording** option to enable the selected camera to record by motion detection.

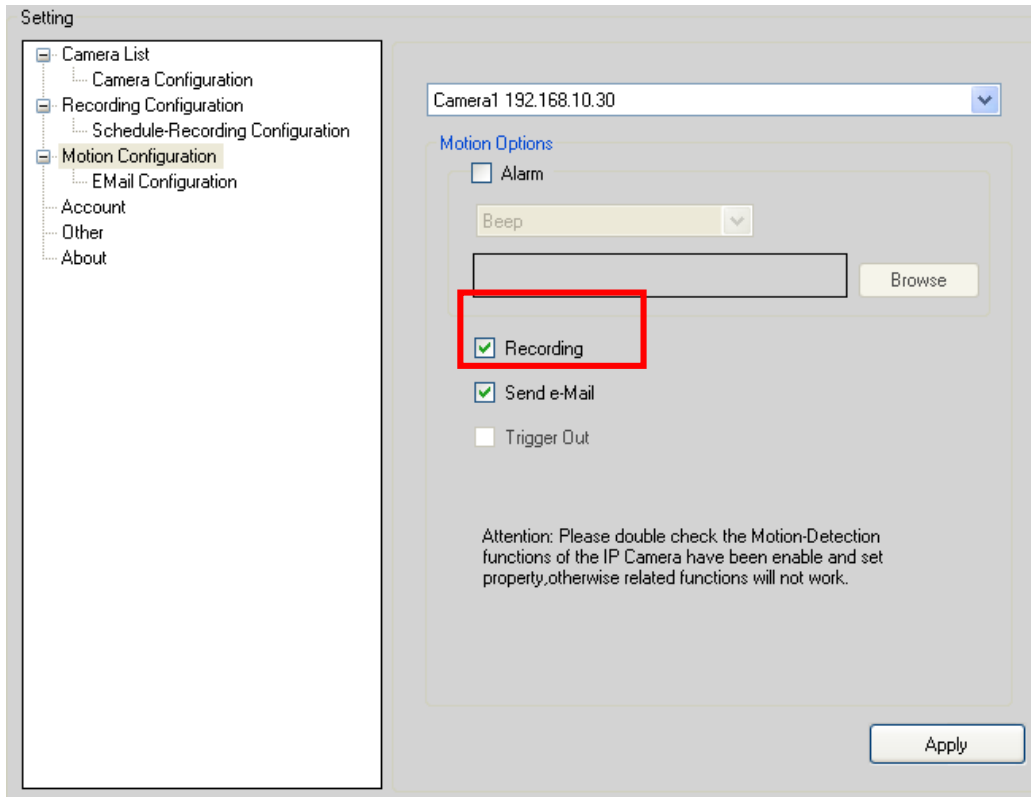

- **Schedule recording Configuration**

This recording method will work after you have completed the required settings in **Schedule Recording Configuration**. The recording schedule can be defined by **Dates** or **Days**.

- **Dates:** Select the camera from the pull-down list..

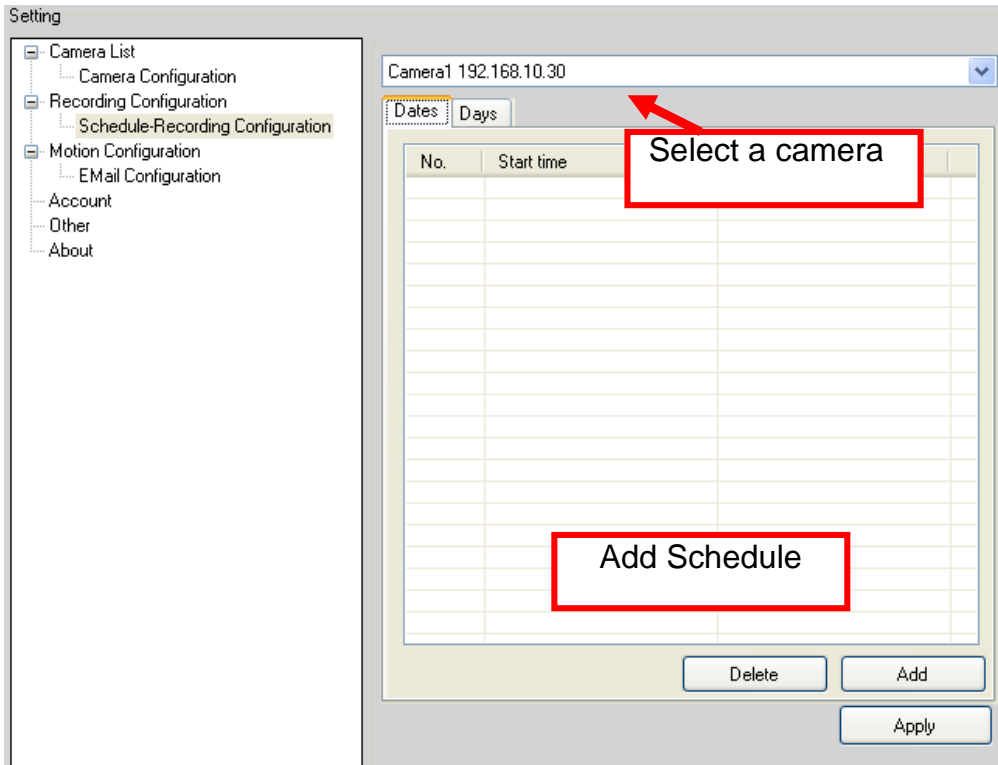

- Then, click **Add** to set the Start/Stop date and time and then click **OK** to add the recording schedule to the list.

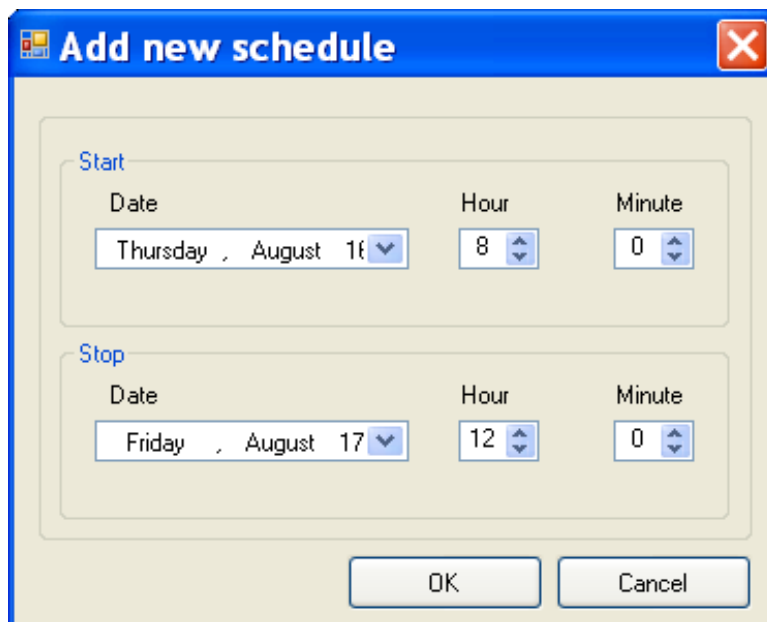

- Click **Apply** to save the settings



**Days:** First, select the camera from the pull-down list and select **Days** tab. Then, select the weekday from the day buttons and then set the time period. Click **Apply** to save the settings.

Camera1 192.168.10.30

Dates Days

Sun Mon Tue Wed Thu Fri Sat

<input type="checkbox"/> 00:00-00:30	<input type="checkbox"/> 07:30-08:00	<input type="checkbox"/> 15:00-15:30	<input type="checkbox"/> 22:30-23:00
<input type="checkbox"/> 00:30-01:00	<input type="checkbox"/> 08:00-08:30	<input type="checkbox"/> 15:30-16:00	<input type="checkbox"/> 23:00-23:30
<input type="checkbox"/> 01:00-01:30	<input type="checkbox"/> 08:30-09:00	<input type="checkbox"/> 16:00-16:30	<input type="checkbox"/> 23:30-00:00
<input type="checkbox"/> 01:30-02:00	<input type="checkbox"/> 09:00-09:30	<input type="checkbox"/> 16:30-17:00	
<input type="checkbox"/> 02:00-02:30	<input type="checkbox"/> 09:30-10:00	<input type="checkbox"/> 17:00-17:30	
<input type="checkbox"/> 02:30-03:00	<input type="checkbox"/> 10:00-10:30	<input type="checkbox"/> 17:30-18:00	
<input type="checkbox"/> 03:00-03:30	<input checked="" type="checkbox"/> 10:30-11:00	<input type="checkbox"/> 18:00-18:30	
<input type="checkbox"/> 03:30-04:00	<input type="checkbox"/> 11:00-11:30	<input type="checkbox"/> 18:30-19:00	
<input type="checkbox"/> 04:00-04:30	<input checked="" type="checkbox"/> 11:30-12:00	<input type="checkbox"/> 19:00-19:30	
<input type="checkbox"/> 04:30-05:00	<input type="checkbox"/> 12:00-12:30	<input type="checkbox"/> 19:30-20:00	
<input type="checkbox"/> 05:00-05:30	<input type="checkbox"/> 12:30-13:00	<input type="checkbox"/> 20:00-20:30	
<input type="checkbox"/> 05:30-06:00	<input type="checkbox"/> 13:00-13:30	<input type="checkbox"/> 20:30-21:00	
<input type="checkbox"/> 06:00-06:30	<input type="checkbox"/> 13:30-14:00	<input type="checkbox"/> 21:00-21:30	
<input type="checkbox"/> 06:30-07:00	<input type="checkbox"/> 14:00-14:30	<input type="checkbox"/> 21:30-22:00	
<input type="checkbox"/> 07:00-07:30	<input type="checkbox"/> 14:30-15:00	<input type="checkbox"/> 22:00-22:30	

< | | >

Fetch Template Paste Template Clear

Apply

## To configure the recording settings

To configure the recording settings, including the storage folder and storage options, click **SETTING > Recording Configuration**.

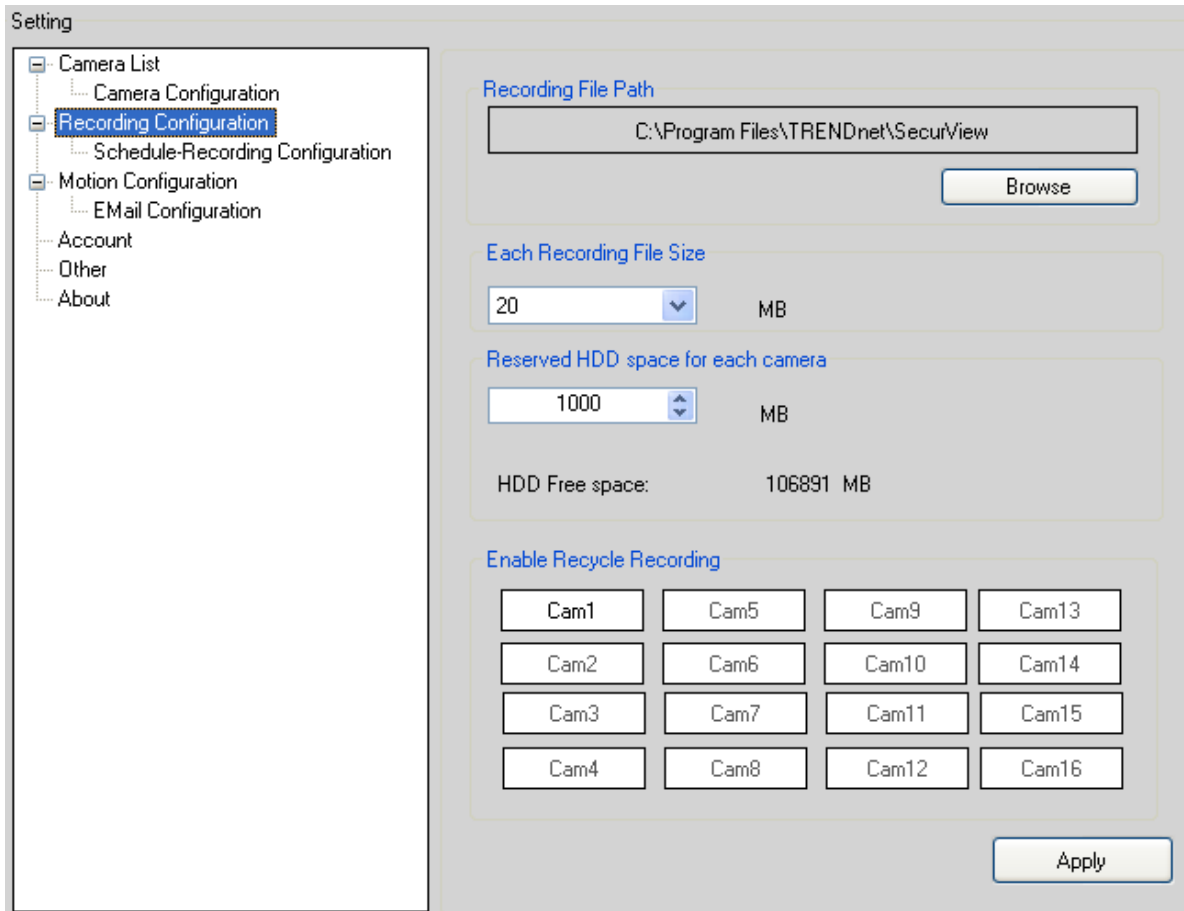

- **Recording File Path:** To change the destination folder to save the recorded video file, click **Browse** under the **Recording File Path** box to assign a new folder.
- **Each Recording File Size:** This option allows you to select from **20** to **100** MB so that the video will be recorded as another file automatically when the recording file reaches the specified size limit.
- **Reserved HDD space for each camera:** This option allows you to set to reserve the storage space on the hard disk drive for the recording of each camera. Before setting the reserve space on the

hard disk drive, you can check the available storage space that is displayed in the **HDD Free space** field.

- **Enable Recycle Recording:** Click on the camera number to clear the files when the unreserved space of the hard disk drive is full.

## To playback the recorded video

The recorded video clips are saved in your computer, and can be played using the media player on the computer, such as Windows Media Player. To start playback, simply click the **PLAY** button on the CONTROLS panel, and the following dialog screen will appear, allowing you to select the file to playback.

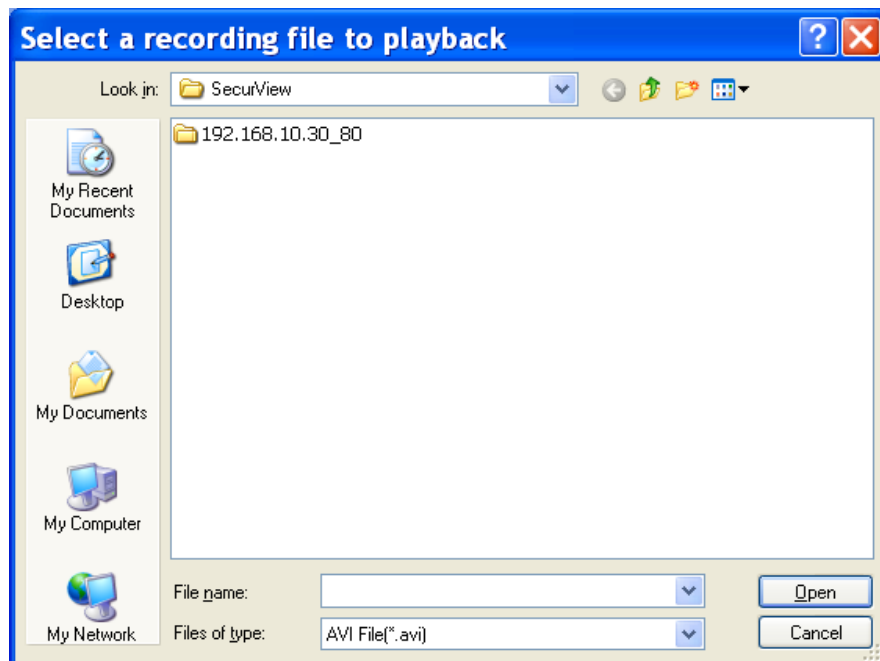

Select the recorded video file under the [camera] path and then click **Open** to launch the media player to playback.



**NOTE** If your player on the computer don't have video codec to playback the recorded video. You can download video codec from <http://www.xvid.org/downloads.15.0.html> to support.

## To set up motion detection options

When the motion detection function of the selected camera is enabled, you can set the **Motion Options** by selecting **Alarm**, **Recording**, **Send e-Mail**, and **Trigger Out** under **SETTING > Motion Configuration**.

Camera1 192.168.10.30

Motion Options

Alarm

Beep

Browse

Recording

Send e-Mail

Trigger Out

Attention: Please double check the Motion-Detection functions of the IP Camera have been enable and set property,otherwise related functions will not work.

Apply

- **Alarm:** Select **Beep** or **Music** to alert you for the motion detected. When you select **Music**, you can customize the sound by clicking

**Browse** and then selecting your favorite music (\*.wav or \*.mp3 file) in the computer.

- **Recording:** Select this option to enable the camera to record by motion detected.
- **Send Email:** Select this option so that the system will be able to send an email to the specified receiver. Once the option is selected, you have to complete the required information in **SETTING > Motion Configuration > Email Configuration.**

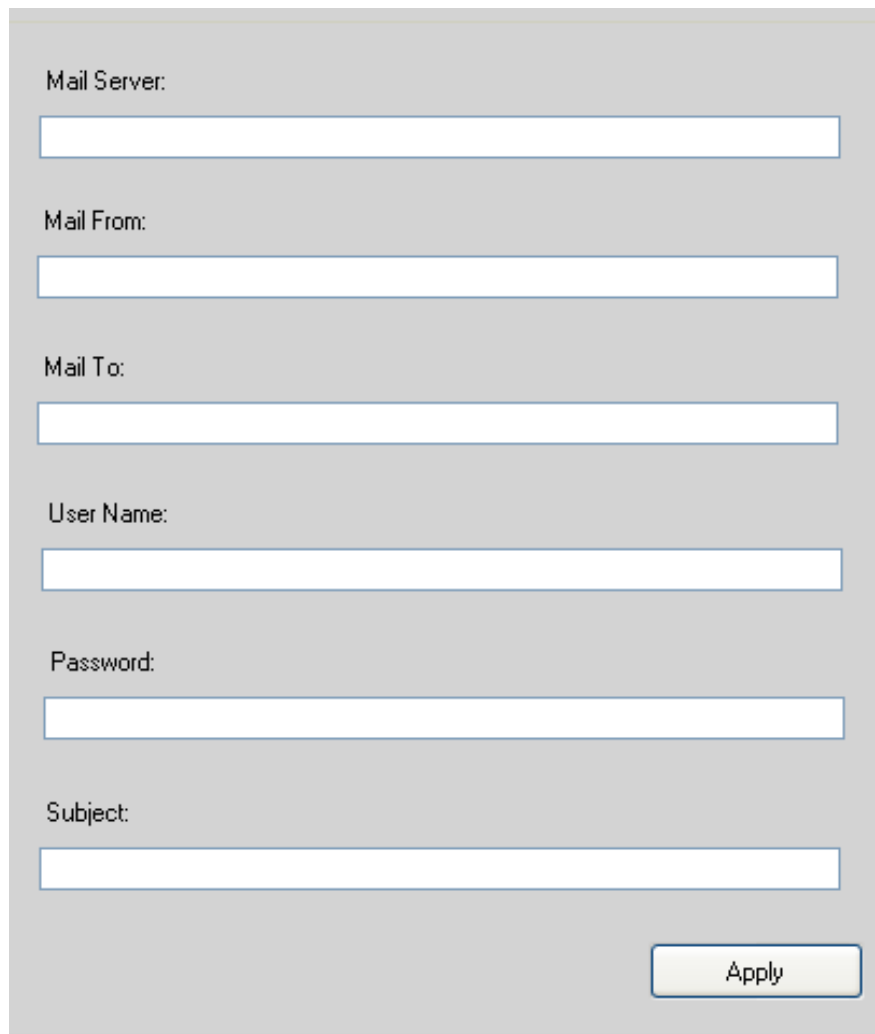

Mail Server:

Mail From:

Mail To:

User Name:

Password:

Subject:

Apply

- **Mail Server:** Enter the mail server address. For example, [mymail.com](mailto:mymail.com).

- **Mail From:** Enter the email address of the user who will send the email. For example, [John@mymail.com](mailto:John@mymail.com).
- **Mail To:** Enter the email address of the user who will receive the email.
- **User Name:** Enter the user name to login the mail server.
- **Password:** Enter the password to login the mail server.
- **Subject:** Enter a subject for the notification email.
- **Trigger Out:** If the selected camera supports Trigger Out connector, select this option to enable the Trigger Out function.

## Account

Click **SETTING > Account** to setup the username & password to lock & unlock the main screen of the SecurView.

## Other

Click **SETTING > Other** to setup the scanning time between cameras. The default setting is 2 seconds. You can set the interval time between 2 ~ 20 seconds.

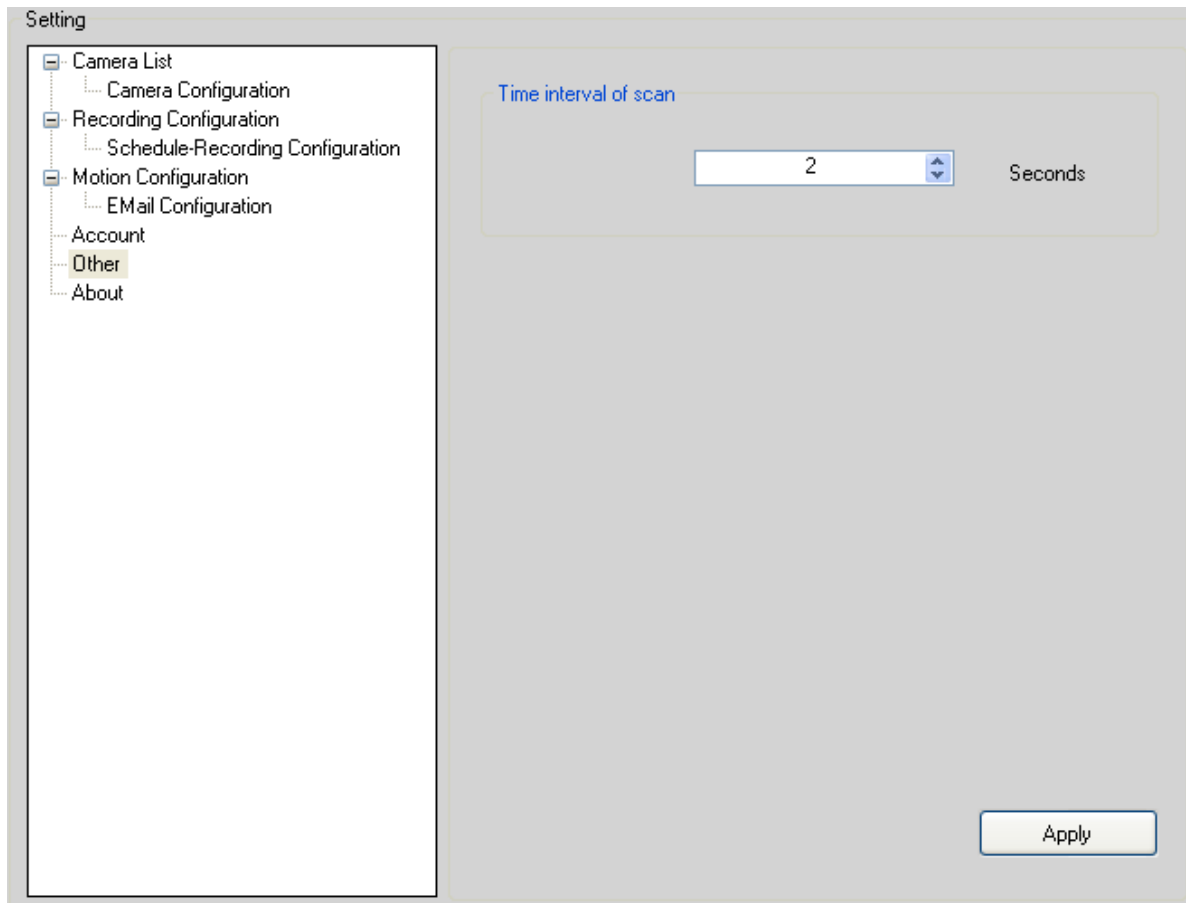

## Information

Click **SETTING** > **About** to display the information of the software application.

Camera List  
 Camera Configuration  
 Recording Configuration  
 Schedule-Recording Configuration  
 Motion Configuration  
 Email Configuration  
 Account  
 Other  
 About

SecurView™ 1.2.0.4

This application is designed to remotely manage the Camera Server.

Warning: This computer program is protected by copyright law and international treaties. Unauthorized reproduction or distribution of this program, or any portion of it, or the use with a registration key without the explicit permission may result in severe criminal and civil penalties, and will be prosecuted to the maximum extent possible under law.

IP Address	Name	Location	Link	Recording	Recycle	Motion	Trig. In
192.168.1.76	TV-IP422W	Office1	OnLink				N/A

---

# APPENDIX

---

## A.1 Specification

### ■ Image Sensor

<b>Sensor</b>	1/4" color CMOS
<b>Resolution</b>	640x480

### ■ Video

<b>Compression</b>	MPEG4/MJPEG
<b>Video resolution</b>	VGA/QVGA/QQVGA; 30fps max.

### ■ Audio

<b>Input</b>	Built-in MIC
<b>Output</b>	Headphone output jack (Mono)
<b>Codec</b>	PCM/AMR (AMR is for 3GPP only)

### ■ User Interface

<b>LAN</b>	One RJ-45 port
<b>Antenna</b>	One external antenna
<b>Reset</b>	One Reset button
<b>USB</b>	USB 1.1 port, with one unmount button; Power distribution: 500mA Max. Support FAT, FAT32 file system
<b>GPIO</b>	1 in/1 out connectors Input: active high: 9~40V DC; dropout: 0V DC

Output: close circuit current 70mA AC or 100mA DC maximum, 30 Ohm; open circuit voltage 240V AC or 350V DC maximum

## **LEDs**

Power LED (amber); Link LED (green)

## ■ **System Hardware**

**Processor** ARM9 base  
**RAM** 32MB SDRAM  
**ROM** 8MB NOR Flash  
**Power** DC 12V

## ■ **Communication**

**LAN** 10/100Mbps Fast Ethernet, auto-sensed, Auto-MDIX  
**WLAN** IEEE 802.11b/g  
**Protocol support** TCP/IP, UDP, ICMP, DHCP, NTP, DNS, DDNS, SMTP, FTP, Samba, PPPoE, UPnP, Bonjour, RTP, RTSP, RTCP

## ■ **Pan/Tilt**

**Pan** 165 degree (left) to 165 degree (right)  
**Tilt** 90 degree (up) to 15 degree (down)

## ■ **Software**

**OS Support** Windows 2000/XP/Vista  
**Browser** Internet Explorer 6.0 or above  
Apple Safari 2 or above  
Mozilla Firefox 2.00 or above  
**Software** SecurView for playback/recording/  
configuration features

## ■ Operating Environment

### Temperature

- Operation: 0°C ~ 45°C
- Storage: -15°C ~ 60°C

### Humidity

- Operation: 20% ~ 85% non-condensing
- Storage: 0% ~ 90% non-condensing

## ■ EMI

FCC Class B, CE Class B

## A.2 GPIO Terminal Application

Typically used in association with programming scripts for developing applications for motion detection, event triggering, alarm notification via e-mail, and a variety of external control functions. The GPIO connectors are located on the rear panel of the camera, which provide the interface of connecting the sensor device (IN) and controlled device (OUT).

### Connector Pin Assignment

PIN	SPECIFICATION
IN	Active High voltage 9~40V DC; Dropout-out voltage 0V DC
OUT	Close circuit current 70mA AC or 100mA DC maximum, Output resistance 30 Ohm; Open circuit voltage 240V AC or 350V DC maximum



## Interface Schematic

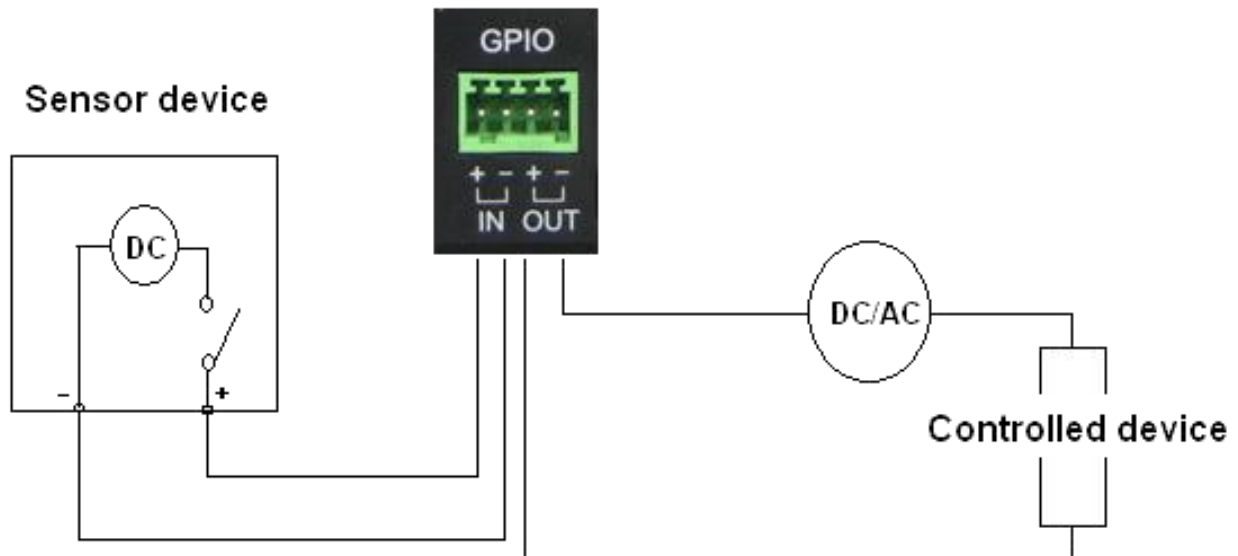

## A.3 Glossary of Terms

### NUMBERS

#### **10BASE-T**

10BASE-T is Ethernet over UTP Category III, IV, or V unshielded twisted-pair media.

#### **100BASE-TX**

The two-pair twisted-media implementation of 100BASE-T is called 100BASE-TX.

### A

#### **ADPCM**

Adaptive Differential Pulse Code Modulation, a new technology improved from PCM, which encodes analog sounds to digital form.

#### **AMR**

AMR (Adaptive Multi-Rate) is an audio data compression scheme optimized for speech coding, which is adopted as the standard speech codec by 3GPP.

#### **Applet**

Applets are small Java programs that can be embedded in an HTML page. The rule at the moment is that an applet can only make an Internet connection to the computer form that

the applet was sent.

## **ASCII**

American Standard Code For Information Interchange, it is the standard method for encoding characters as 8-bit sequences of binary numbers, allowing a maximum of 256 characters.

## **ARP**

Address Resolution Protocol. ARP is a protocol that resides at the TCP/IP Internet layer that delivers data on the same network by translating an IP address to a physical address.

## **AVI**

Audio Video Interleave, it is a Windows platform audio and video file type, a common format for small movies and videos.

## **B**

### **BOOTP**

Bootstrap Protocol is an Internet protocol that can automatically configure a network device in a diskless workstation to give its own IP address.

## **C**

### **Communication**

Communication has four components: sender, receiver, message, and medium. In networks, devices and application tasks and processes communicate messages to each other over media. They represent the sender and receivers. The data they send is the message. The cabling or transmission method they use is the medium.

### **Connection**

In networking, two devices establish a connection to communicate with each other.

## **D**

### **DHCP**

Developed by Microsoft, DHCP (Dynamic Host Configuration Protocol) is a protocol for assigning dynamic IP addresses to devices on a network. With dynamic addressing, a device can have a different IP address every time it connects to the network. In some systems, the device's IP address can even change while it is still connected. It also supports a mix of

static and dynamic IP addresses. This simplifies the task for network administrators because the software keeps track of IP addresses rather than requiring an administrator to manage the task. A new computer can be added to a network without the hassle of manually assigning it a unique IP address. DHCP allows the specification for the service provided by a router, gateway, or other network device that automatically assigns an IP address to any device that requests one.

## **DNS**

Domain Name System is an Internet service that translates domain names into IP addresses. Since domain names are alphabetic, they're easier to remember. The Internet however, is really based on IP addresses every time you use a domain name the DNS will translate the name into the corresponding IP address. For example, the domain name *www.network\_camera.com* might translate to *192.167.222.8*.

## **E**

### **Enterprise network**

An enterprise network consists of collections of networks connected to each other over a geographically dispersed area. The enterprise network serves the needs of a widely distributed company and operates the company's mission-critical applications.

### **Ethernet**

The most popular LAN communication technology. There are a variety of types of Ethernet, including 10Mbps (traditional Ethernet), 100Mbps (Fast Ethernet), and 1,000Mbps (Gigabit Ethernet). Most Ethernet networks use Category 5 cabling to carry information, in the form of electrical signals, between devices. Ethernet is an implementation of CSMA/CD that operates in a bus or star topology.

## **F**

### **Fast Ethernet**

Fast Ethernet, also called 100BASE-T, operates at 10 or 100Mbps per second over UTP, STP, or fiber-optic media.

## **Firewall**

Firewall is considered the first line of defense in protecting private information. For better security, data can be encrypted. A system designed to prevent unauthorized access to or from a private network. Firewalls are frequently used to prevent unauthorized Internet users from accessing private networks connected to the Internet, especially Intranets all messages entering or leaving the intranet pass through the firewall, which examines each message and blocks those that do not meet the specified security criteria.

## **G**

### **Gateway**

A gateway links computers that use different data formats together.

### **Group**

Groups consist of several user machines that have similar characteristics such as being in the same department.

## **H**

### **HEX**

Short for hexadecimal refers to the base-16 number system, which consists of 16 unique symbols: the numbers 0 to 9 and the letters A to F. For example, the decimal number 15 is represented as F in the hexadecimal numbering system. The hexadecimal system is useful because it can represent every byte (8 bits) as two consecutive hexadecimal digits. It is easier for humans to read hexadecimal numbers than binary numbers.

## **I**

### **Intranet**

This is a private network, inside an organization or company that uses the same software you will find on the public Internet. The only difference is that an Intranet is used for internal usage only.

### **Internet**

The Internet is a globally linked system of computers that are logically connected based on the Internet Protocol (IP). The Internet provides different ways to access private and public information worldwide.

- Internet address** To participate in Internet communications and on Internet Protocol-based networks, a node must have an Internet address that identifies it to the other nodes. All Internet addresses are IP addresses
- IP** Internet Protocol is the standard that describes the layout of the basic unit of information on the Internet (the *packet*) and also details the numerical addressing format used to route the information. Your Internet service provider controls the IP address of any device it connects to the Internet. The IP addresses in your network must conform to IP addressing rules. In smaller LANs, most people will allow the DHCP function of a router or gateway to assign the IP addresses on internal networks.
- IP address** IP address is a 32-binary digit number that identifies each sender or receiver of information that is sent in packets across the Internet. For example 80.80.80.69 is an IP address. When you “call” that number, using any connection methods, you get connected to the computer that “owns” that IP address.
- ISP** ISP (Internet Service Provider) is a company that maintains a network that is linked to the Internet by way of a dedicated communication line. An ISP offers the use of its dedicated communication lines to companies or individuals who can't afford the high monthly cost for a direct connection.
- J**
- JAVA** Java is a programming language that is specially designed for writing programs that can be safely downloaded to your computer through the Internet without the fear of viruses. It is an object-oriented multi-thread programming best for creating applets and applications for the Internet, Intranet and other complex, distributed network.
- L**
- LAN** Local Area Network a computer network that spans a relatively small area sharing common resources. Most LANs are confined to a single building or group of buildings.

## **M**

### **MJPEG**

MJPEG (Motion JPEG) composes a moving image by storing each frame of a moving picture sequence in JPEG compression, and then decompressing and displaying each frame at rapid speed to show the moving picture.

### **MPEG4**

MPEG4 is designed to enable transmission and reception of high-quality audio and video over the Internet and next-generation mobile telephones.

## **N**

### **NAT**

Network Address Translator generally applied by a router that makes many different IP addresses on an internal network appear to the Internet as a single address. For routing messages properly within your network, each device requires a unique IP address. But the addresses may not be valid outside your network. NAT solves the problem. When devices within your network request information from the Internet, the requests are forwarded to the Internet under the router's IP address. NAT distributes the responses to the proper IP addresses within your network.

### **Network**

A network consists of a collection of two or more devices, people, or components that communicate with each other over physical or virtual media. The most common types of network are:

**LAN** – (local area network): Computers are in close distance to one another. They are usually in the same office space, room, or building.

**WAN** – (wide area network): The computers are in different geographic locations and are connected by telephone lines or radio waves.

### **NWay Protocol**

A network protocol that can automatically negotiate the highest possible transmission speed between two devices.

## **P**

### **PCM**

PCM (Pulse Code Modulation) is a technique for converting analog audio signals into digital form for transmission.

### **PING**

Packet Internet Groper, a utility used to determine whether a specific IP address is accessible. It functions by sending a packet to the specified address and waits for a reply. It is primarily used to troubleshoot Internet connections.

### **PPPoE**

Point-to-Point Protocol over Ethernet. PPPoE is a specification for connecting the users on an Ethernet to the Internet through a common broadband medium, such as DSL or cable modem. All the users over the Ethernet share a common connection.

### **Protocol**

Communication on the network is governed by sets of rules called protocols. Protocols provide the guidelines devices use to communicate with each other, and thus they have different functions. Some protocols are responsible for formatting and presenting and presenting data that will be transferred from file server memory to the file server's network adapter Others are responsible for filtering information between networks and forwarding data to its destination. Still other protocols dictate how data is transferred across the medium, and how servers respond to workstation requests and vice versa. Common network protocols responsible for the presentation and formatting of data for a network operating system are the Internetwork Packet Exchange (IPX) protocol or the Internet Protocol (IP). Protocols that dictate the format of data for transferors the medium include token-passing and Carrier Sense Multiple Access with Collision Detection (CSMA/CD), implemented as token-ring, ARCNET, FDDI, or Ethernet. The Router Information Protocol (RIP), a part of the Transmission Control Protocol/Internet Protocol (TCP/IP) suite, forwards packets from one network to another using the same network protocol.

## **R**

**RJ-45** RJ-45 connector is used for Ethernet cable connections.

**Router** A router is the network software or hardware entity charged with routing packets between networks.

**RTP** RTP (Real-time Transport Protocol) is a data transfer protocol defined to deliver **live media** to the clients at the same time, which defines the transmission of video and audio files in real time for Internet applications.

**RTSP** RTSP (Real-time Streaming Protocol) is the standard used to transmit **stored media** to the client(s) at the same time, which provides client controls for random access to the content stream.

## S

**Server** It is a simple computer that provides resources, such as files or other information.

**SIP** SIP (Session Initiated Protocol) is a standard protocol that delivers the real-time communication for Voice over IP (VoIP), which establishes sessions for features such as audio and video conferencing.

**SMTP** The Simple Mail Transfer Protocol is used for Internet mail.

**SNMP** Simple Network Management Protocol. SNMP was designed to provide a common foundation for managing network devices.

**Station** In LANs, a station consists of a device that can communicate data on the network. In FDDI, a station includes both physical nodes and addressable logical devices. Workstations, single-attach stations, dual-attach stations, and concentrators are FDDI stations.

**Subnet mask** In TCP/IP, the bits used to create the subnet are called the subnet mask.

## T

**(TCP/IP)** Transmission Control Protocol/Internet Protocol is a widely used transport protocol that connects diverse computers of



various transmission methods. It was developed by the Department of Defense to connect different computer types and led to the development of the Internet.

**Transceiver**

A transceiver joins two network segments together. Transceivers can also be used to join a segment that uses one medium to a segment that uses a different medium. On a 10BASE-5 network, the transceiver connects the network adapter or other network device to the medium. Transceivers also can be used on 10BASE-2 or 10BASE-T networks to attach devices with AUI ports.

**U**

**UDP**

The User Datagram Protocol is a connectionless protocol that resides above IP in the TCP/IP suite

**User Name**

The USERNAME is the unique name assigned to each person who has access to the LAN.

**Utility**

It is a program that performs a specific task.

**UTP**

Unshielded twisted-pair. UTP is a form of cable used by all access methods. It consists of several pairs of wires enclosed in an unshielded sheath.

**W**

**WAN**

Wide-Area Network. A wide-area network consists of groups of interconnected computers that are separated by a wide distance and communicate with each other via common carrier telecommunication techniques.

**WEP**

WEP is widely used as the basic security protocol in Wi-Fi networks, which secures data transmissions using 64-bit or 128-bit encryption.

**Windows**

Windows is a graphical user interface for workstations that use DOS.

**WPA**

WPA (Wi-Fi Protected Access ) is used to improve the security of Wi-Fi networks, replacing the current WEP standard. It uses its own encryption, Temporal Key Integrity Protocol

(TKIP), to secure data during transmission.

## **WPA2**

Wi-Fi Protected Access 2, the latest security specification that provides greater data protection and network access control for Wi-Fi networks. WPA2 uses the government-grade AES encryption algorithm and IEEE 802.1X-based authentication, which are required to secure large corporate networks.

# Limited Warranty

TRENDnet warrants its products against defects in material and workmanship, under normal use and service, for the following lengths of time from the date of purchase.

## **TV-IP422/TV-IP422W– 3 Years Warranty**

If a product does not operate as warranted above during the applicable warranty period, TRENDnet shall, at its option and expense, repair the defective product or part, deliver to customer an equivalent product or part to replace the defective item, or refund to customer the purchase price paid for the defective product. All products that are replaced will become the property of TRENDnet. Replacement products may be new or reconditioned.

TRENDnet shall not be responsible for any software, firmware, information, or memory data of customer contained in, stored on, or integrated with any products returned to TRENDnet pursuant to any warranty.

There are no user serviceable parts inside the product. Do not remove or attempt to service the product by any unauthorized service center. This warranty is voided if (i) the product has been modified or repaired by any unauthorized service center, (ii) the product was subject to accident, abuse, or improper use (iii) the product was subject to conditions more severe than those specified in the manual.

Warranty service may be obtained by contacting TRENDnet office within the applicable warranty period for a Return Material Authorization (RMA) number, accompanied by a copy of the dated proof of the purchase. Products returned to TRENDnet must be pre-authorized by TRENDnet with RMA number marked on the outside of the package, and sent prepaid, insured and packaged appropriately for safe shipment.

**WARRANTIES EXCLUSIVE:** IF THE TRENDNET PRODUCT DOES NOT OPERATE AS WARRANTED ABOVE, THE CUSTOMER'S SOLE REMEDY SHALL BE, AT TRENDNET'S OPTION, REPAIR OR REPLACEMENT. THE FOREGOING WARRANTIES AND REMEDIES ARE EXCLUSIVE AND ARE IN LIEU OF ALL OTHER WARRANTIES, EXPRESSED OR IMPLIED, EITHER IN FACT OR BY OPERATION OF LAW, STATUTORY OR OTHERWISE, INCLUDING WARRANTIES OF MERCHANTABILITY AND FITNESS FOR A PARTICULAR PURPOSE. TRENDNET NEITHER ASSUMES NOR AUTHORIZES ANY OTHER PERSON TO ASSUME FOR IT ANY OTHER LIABILITY IN CONNECTION WITH THE SALE, INSTALLATION MAINTENANCE OR USE OF TRENDNET'S PRODUCTS.

TRENDNET SHALL NOT BE LIABLE UNDER THIS WARRANTY IF ITS TESTING AND EXAMINATION DISCLOSE THAT THE ALLEGED DEFECT IN THE PRODUCT DOES NOT EXIST OR WAS CAUSED BY CUSTOMER'S OR ANY THIRD PERSON'S MISUSE, NEGLIGENCE, IMPROPER INSTALLATION OR TESTING, UNAUTHORIZED ATTEMPTS TO REPAIR OR MODIFY, OR ANY OTHER CAUSE BEYOND THE RANGE OF THE INTENDED USE, OR BY ACCIDENT, FIRE, LIGHTNING, OR OTHER HAZARD.

LIMITATION OF LIABILITY: TO THE FULL EXTENT ALLOWED BY LAW TRENDNET ALSO EXCLUDES FOR ITSELF AND ITS SUPPLIERS ANY LIABILITY, WHETHER BASED IN CONTRACT OR TORT (INCLUDING NEGLIGENCE), FOR INCIDENTAL, CONSEQUENTIAL, INDIRECT, SPECIAL, OR PUNITIVE DAMAGES OF ANY KIND, OR FOR LOSS OF REVENUE OR PROFITS, LOSS OF BUSINESS, LOSS OF INFORMATION OR DATA, OR OTHER FINANCIAL LOSS ARISING OUT OF OR IN CONNECTION WITH THE SALE, INSTALLATION, MAINTENANCE, USE, PERFORMANCE, FAILURE, OR INTERRUPTION OF THE POSSIBILITY OF SUCH DAMAGES, AND LIMITS ITS LIABILITY TO REPAIR, REPLACEMENT, OR REFUND OF THE PURCHASE PRICE PAID, AT TRENDNET'S OPTION. THIS DISCLAIMER OF LIABILITY FOR DAMAGES WILL NOT BE AFFECTED IF ANY REMEDY PROVIDED HEREIN SHALL FAIL OF ITS ESSENTIAL PURPOSE.

**Governing Law:** This Limited Warranty shall be governed by the laws of the state of California.

AC/DC Power Adapter, Cable, Cooling Fan, and Power Supply carry 1 year warranty.



# TRENDnet<sup>®</sup>

## TRENDnet Technical Support

### US • Canada

**Toll Free Telephone:** 1(866) 845-3673

24/7 Tech Support



### Europe (Germany • France • Italy • Spain • Switzerland • UK)

**Toll Free Telephone:** +00800 60 76 76 67

English/Espanol - 24/7

Francais/Deutsch - 11 am-8pm, Monday - Friday MET

### Worldwide

**Telephone:** +[31] [0] 20 504 05 35

English/Espanol - 24/7

Francais/Deutsch - 11 am-8pm, Monday - Friday MET

## Product Warranty Registration

Please take a moment to register your product online.

Go to TRENDnet's website at <http://www.trendnet.com/register>

# TRENDnet<sup>®</sup>

20675 Manhattan Place  
Torrance, CA 90501  
USA