

# TRENDnet<sup>®</sup>



---

## Quick Installation Guide

### TV-IP312PI (V1)

# Table of Content

---

## **1 English**

1. Before You Start
2. Hardware Installation and Configuration

# 1. Before You Start

---

## Package Contents

- TV-IP312PI
- CD-ROM (Utility and User's Guide)
- Quick Installation Guide
- Mounting kit

## Minimum Requirements

- Power over Ethernet (PoE) switch (e.g. TPE-S50) or PoE Injector (e.g. TPE-113GI)
- A networked computer and web browser
- Wired network
- Network cable

**Note:** The TV-IP312PI only works with Power over Ethernet (PoE) devices that follow the IEEE 802.3af standard.

## Free Mobile App: TRENDnet IPView Requirements

| Supported Operating Systems                                      |
|--|
| Android (version 2.3.3 or above)<br>iOS (version 5.1.1 or above) |

## 2. Hardware Installation and Configuration

**Note:** You can also download the utility at <http://www.trendnet.com/support/TV-IP312PI>.

1. Do not install or mount the IP camera until after you complete the installation steps below. Temporarily place the IP camera next to your computer.
2. Insert the Utility CD-ROM into your CD-ROM drive.



3. Click **Install Camera Utility**.

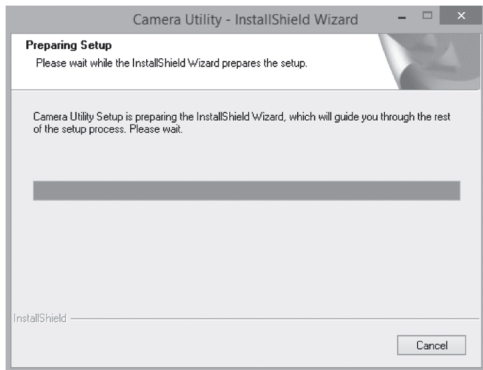

4. Run the utility and you will see your camera is set to Inactive under security.

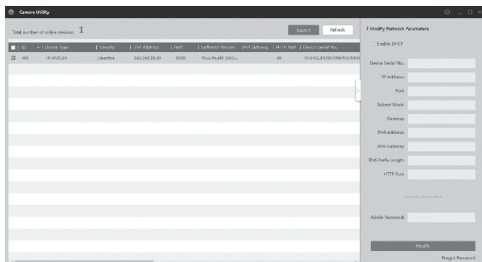

5. After the utility is done scanning. Click on the IP address section of the camera you would like to access.

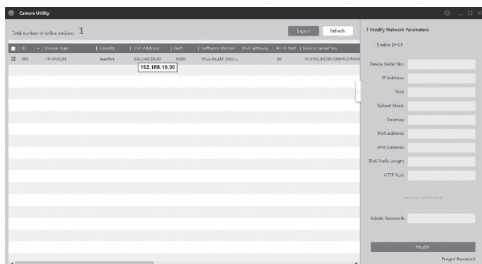

6. Once you get to the login page you will be prompted to change the password. Please follow the password requirements and enter your new password.

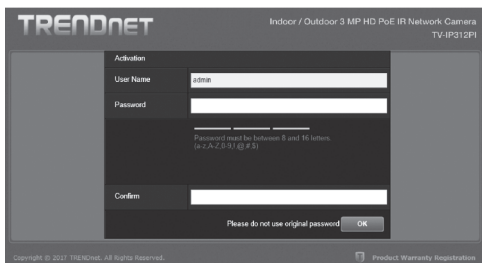

7. Once you login the camera will prompt you for a password change. Please change the default password.

Please enter your new administrator password

|           |                                    |
|-----------|------------------------------------|
| User Name | <input type="text" value="admin"/> |
| Password  | <input type="password"/>           |
| Confirm   | <input type="password"/>           |

OK

8. Now you can access the camera's configuration page for Live view and additional settings. For more details, please refer to the User's Guide.
9. Scan the QR code below to download a free mobile app to view the camera from your IOS or Android device. Please refer to the quick install guide for instructions on how to setup your camera in the app from your cameras download page at [www.TRENDnet.com](http://www.TRENDnet.com).



Android



iOS

## Using the TV-IP312PI with a PoE switch (TPE-S50)

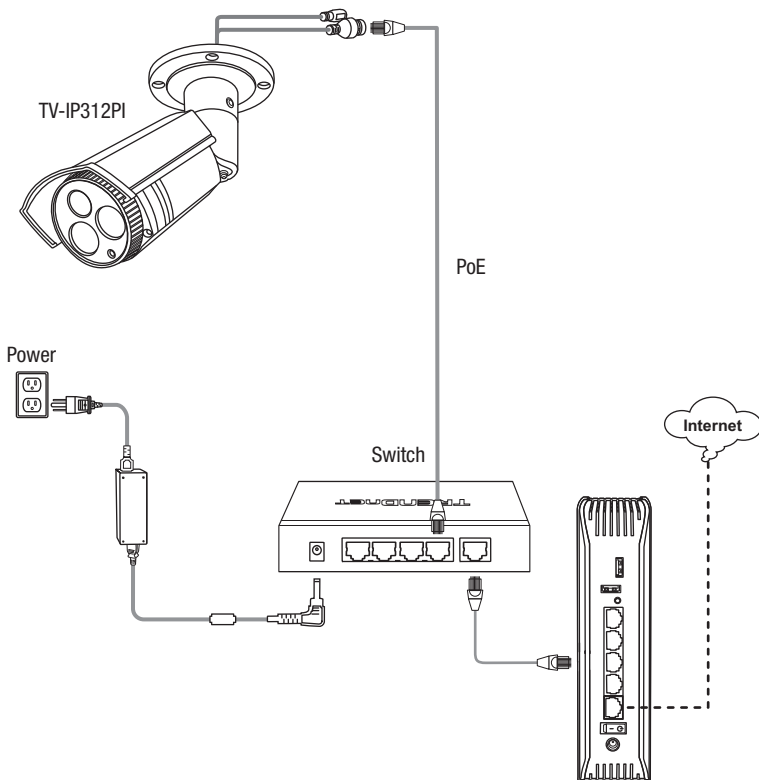

- Connect the provided network cable from the Power over Ethernet switch (e.g. TPE-S50) to the network port on the IP Camera.
- Connect the switch to your network.

## Mounting the camera

**Note:** For tips on capturing appropriate camera viewing angle, please refer to the user's guide.

1. Loosen the adjustable nut and manually position the camera as desire.

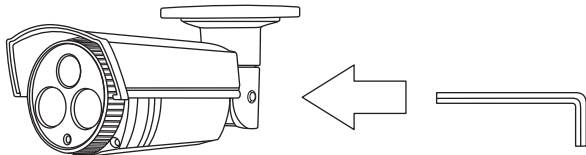

2. Place the provided template label on the wall or ceiling.

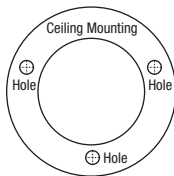

3. Drill holes at each marked position on the template. Make sure the drill bit matches the size of the holes on the template.
4. Insert the provided screw anchors into the holes.
5. Insert the cables through the hole in the wall or ceiling.



6. Align the mounting bracket with the screw anchors, and then use the provided screws to secure the camera to the mounting surface.

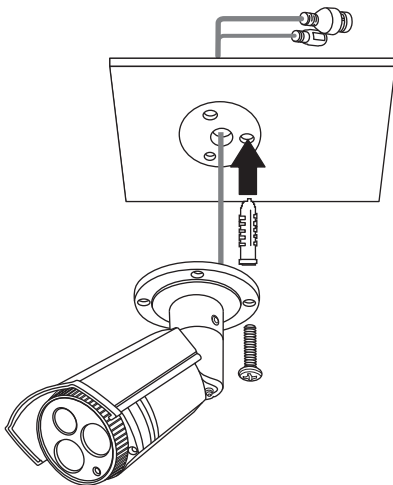

7. Manually adjust the zoom and focus. Using the free app, confirm the zoom and focus matches installation requirements.

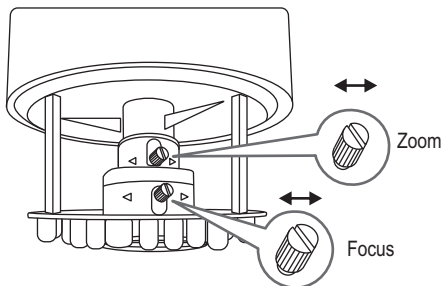

8. Refer to User's Guide for more details on installation and configuration.

# Declaration of Conformity

TRENDnet<sup>®</sup>

## Manufacturer's Name and Address

TRENDnet, Inc.  
20675 Manhattan Place  
Torrance, CA 90501 USA

Zwolsestraat 156 2587 WB  
The Hague The Netherlands



## Product Information

**Model Number:** TV-IP312PI  
**Product Name:** Indoor/Outdoor 3MP HD PoE IR Network Camera  
**Trade Name:** TRENDnet

TRENDnet hereby declare that the product is in compliance with the essential requirements and other relevant provisions under our sole responsibility.

## EMC

EN 55022: 2010 + AC: 2011 Class A  
EN 61000-3-2: 2006 + A1: 2009 + A2: 2009  
EN 61000-3-3: 2008  
EN 50130-4: 2011 + A1: 2014

This product is herewith confirmed to comply with the Directives.

## Directives:

Directive LVD 2014/35/EU  
Directive EMC 2014/30/EU  
Directive RoHS 2011/65/UE  
REACH Règlement (CE) N° 1907/2006

Person responsible for this declaration.

Place of Issue: Torrance, California, USA

Date: January 05, 2017

Name: Sonny Su

Title: Director of Technology

Signature:

A handwritten signature in black ink, appearing to read 'Sonny Su', is written over a horizontal line.

## Certifications

This device complies with Part 15 of the FCC Rules. Operation is subject to the following two conditions:  
(1) this device may not cause harmful interference, and  
(2) this device must accept any interference received.  
Including interference that may cause undesired operation.



Waste electrical and electronic products must not be disposed of with household waste. Please recycle where facilities exist. Check with your Local Authority or Retailer for recycling advice.

Applies to PoE Products Only: This product is to be connected only to PoE networks without routing to the outside plant.

## Note

The Manufacturer is not responsible for any radio or TV interference caused by unauthorized modifications to this equipment. Such modifications could void the user's authority to operate the equipment.

## Advertencia

En todos nuestros equipos se mencionan claramente las características del adaptador de alimentación necesario para su funcionamiento. El uso de un adaptador distinto al mencionado puede producir daños físicos y/o daños al equipo conectado. El adaptador de alimentación debe operar con voltaje y frecuencia de la energía eléctrica domiciliaria existente en el país o zona de instalación.

## Technical Support

If you have any questions regarding the product installation, please contact our Technical Support.

Toll free US/Canada: **1-866-845-3673**

Regional phone numbers available at [www.trendnet.com/support](http://www.trendnet.com/support)

## TRENDnet

20675 Manhattan Place  
Torrance, CA 90501  
USA

## Product Warranty Registration

Please take a moment to register your product online. Go to TRENDnet's website at:  
**[www.trendnet.com/register](http://www.trendnet.com/register)**