

## Quick Installation Guide

TV-IP1514PI  
TV-IP1515PI  
TV-NVR1508

### Hardware Installation

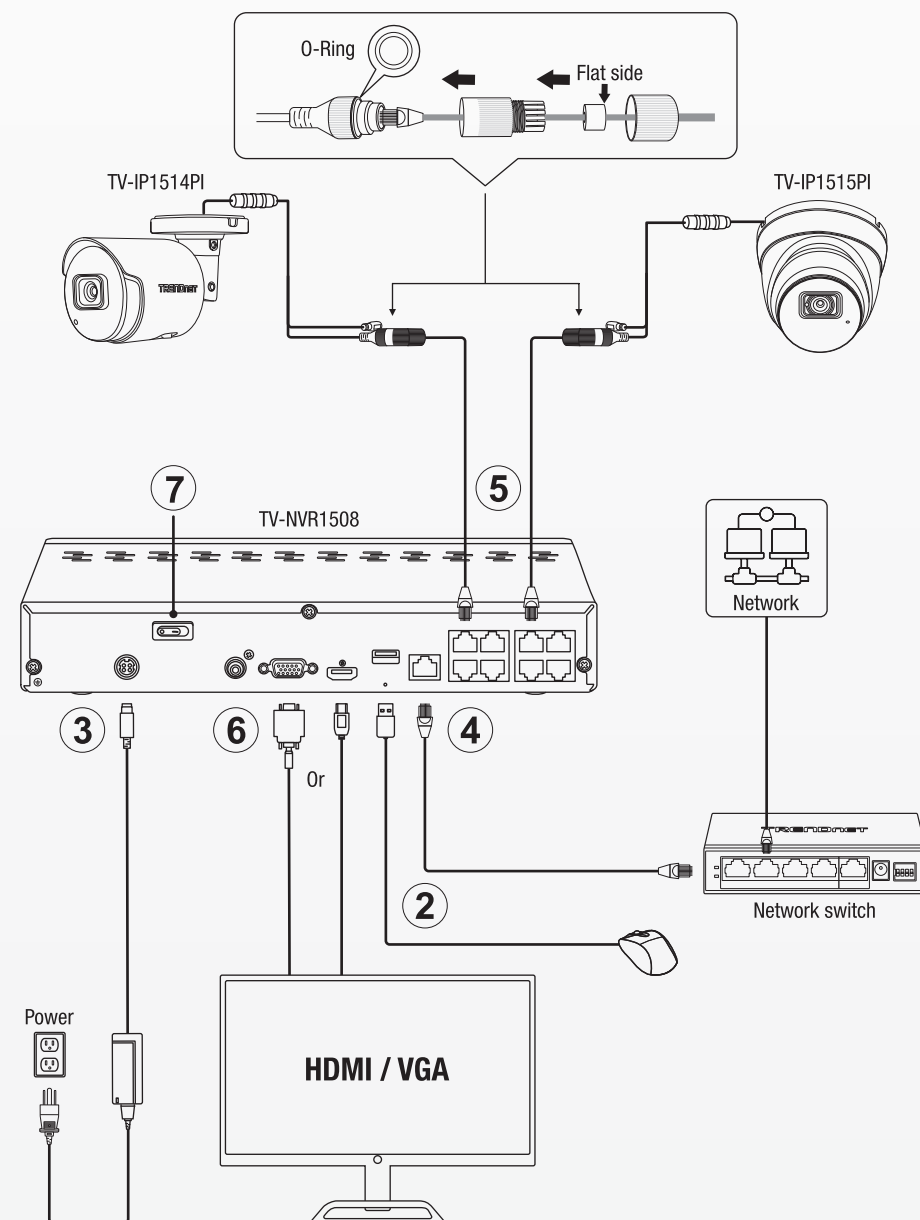

1. Install hard drive. Refer to the diagram on the right.
2. Plug a USB mouse into the USB port.
3. Plug the power adapter into the NVR's power socket.
4. Connect the NVR to a network switch.
5. Connect PoE IP cameras to the NVR's PoE ports with network cables.
6. Connect a monitor to the NVR with a HDMI or VGA cable.
7. Make sure all cables are properly connected and power on the NVR.

### TRENDnet Sentinel (Free Mobile App)

1. Download and Install Sentinel

#### Supported Operating Systems

Android (version 12 or above)  
iOS (version 11 or above)



Sentinel iOS



Sentinel Android

2. Tap the "+" sign to add the NVR then tap Scan QR Code on the bottom of the devices.

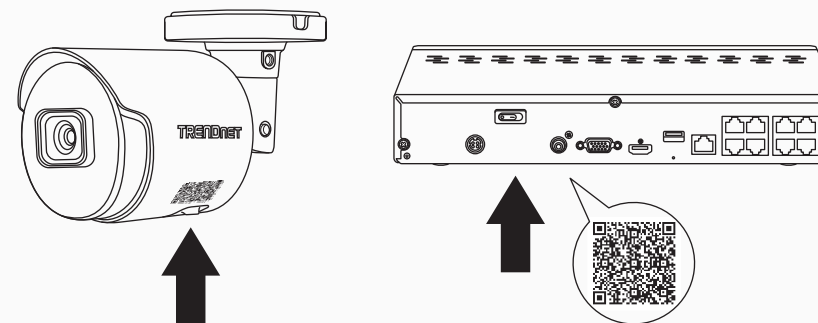

3. To activate a new NVR or camera you will need to create a password then tap on **Activate**.

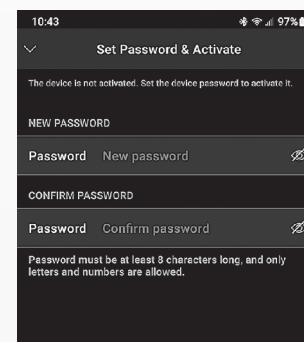

4. Once added you should see a live image from the NVR or camera.



### 1 Hard drive Installation

Skip to App installation if you do not have NVR.

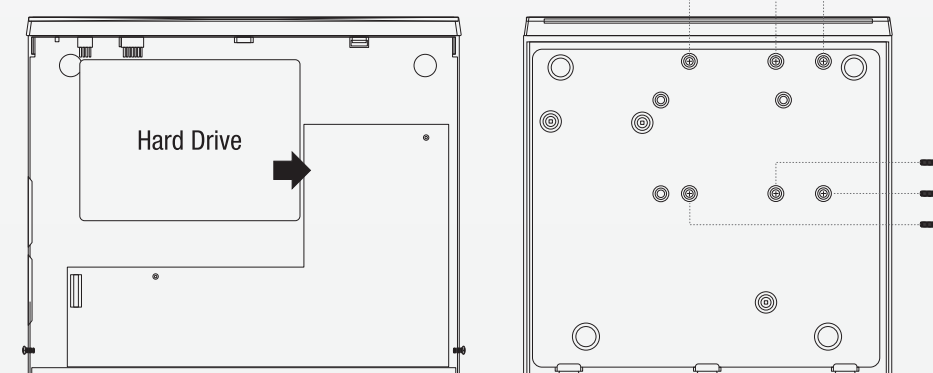

### Mounting the Camera

Place the provided template label on the wall or ceiling. Drill holes at each marked position on the template. Make sure the drill bit matches the size of the holes on the template.

For TV-IP1514PI

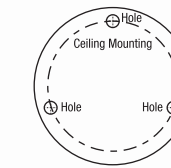

For TV-IP1515PI

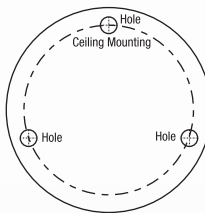

### Bullet Camera Installation

#### Ceiling Mounting

Insert 3 anchors into the ceiling and affix the camera with 3 screws.

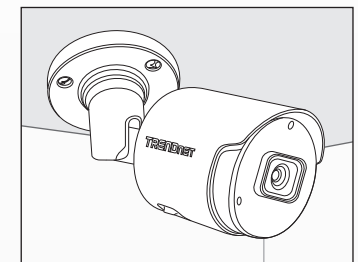
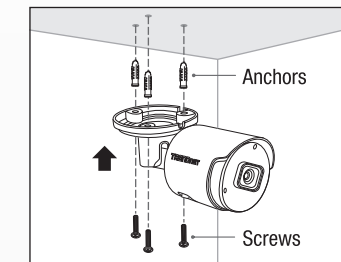

#### Wall Mounting

Insert 3 anchors into the wall and affix the camera with 3 screws.

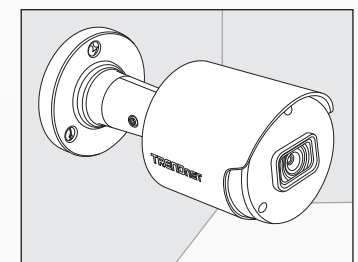
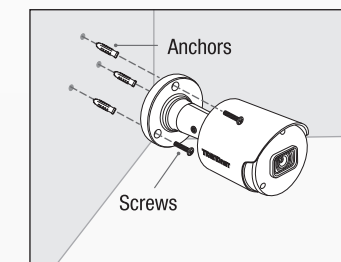

### Mini Dome Camera Installation

#### Ceiling Mounting

Remove the fixed ring off the camera by rotating it down clockwise.

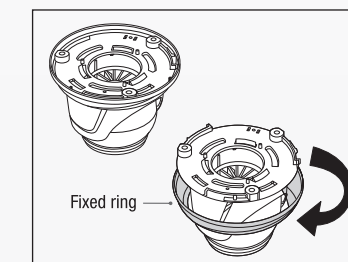

Insert 3 anchors into the ceiling and affix the camera with 3 screws.

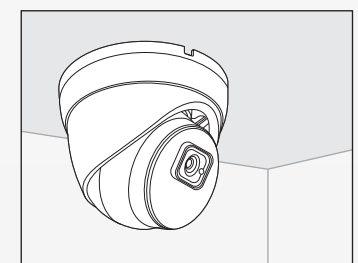
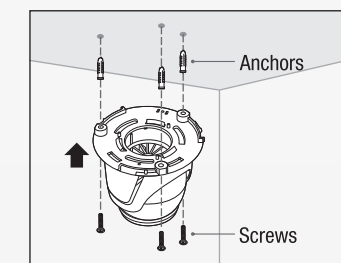

Adjust the camera to your desired angle then mount the fixed ring back into place by rotating it up counter-clockwise until locked.

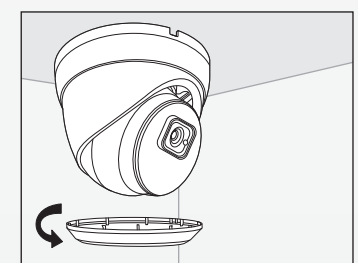
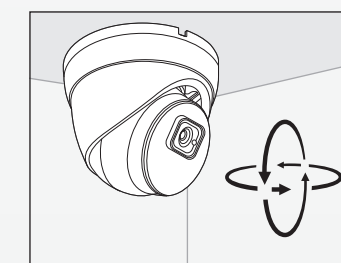

For additional configuration information, please refer to the user's guide.

