

Quick Installation Guide

TV-IP1514PI
TV-IP1515PI
TV-NVR1508

Hardware Installation

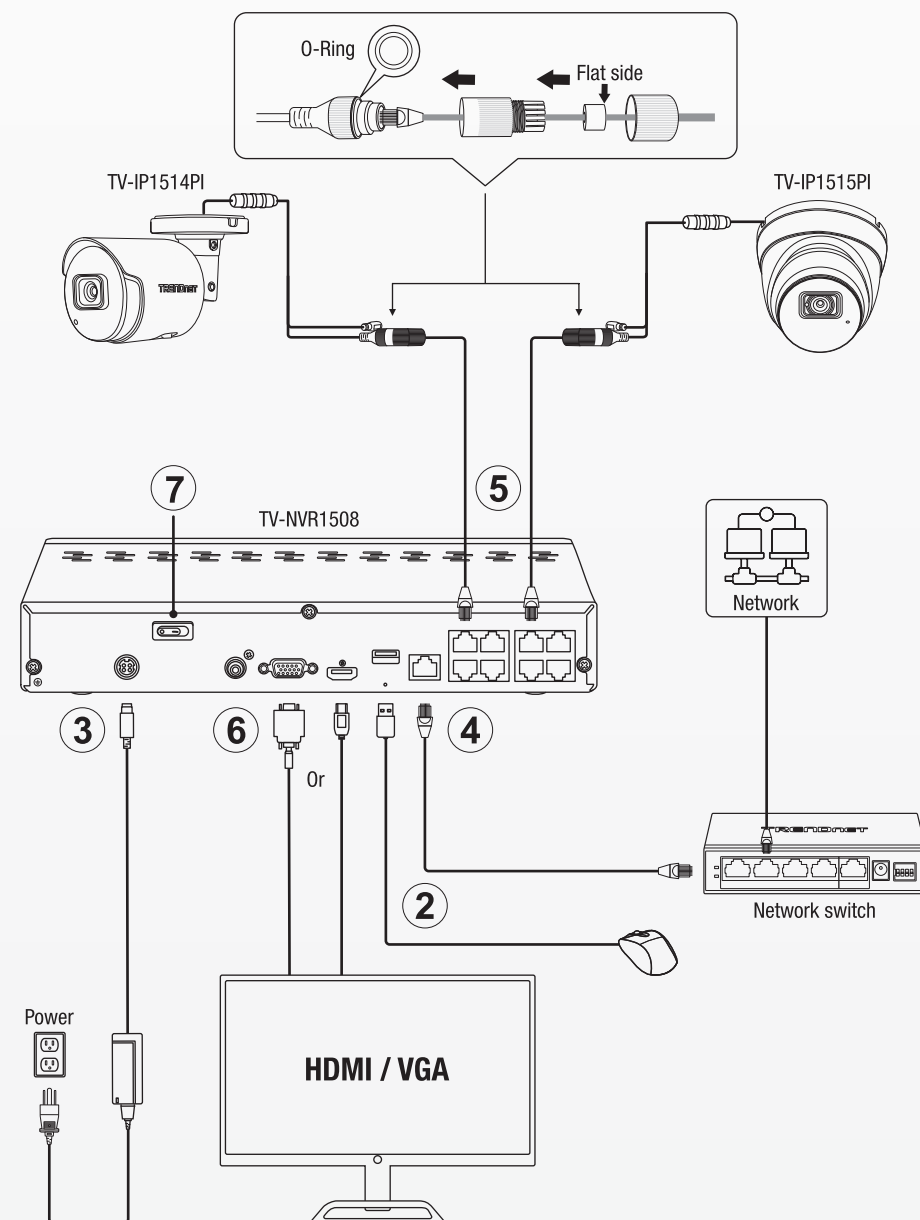

1. Install hard drive. Refer to the diagram on the right.
2. Plug a USB mouse into the USB port.
3. Plug the power adapter into the NVR's power socket.
4. Connect the NVR to a network switch.
5. Connect PoE IP cameras to the NVR's PoE ports with network cables.
6. Connect a monitor to the NVR with a HDMI or VGA cable.
7. Make sure all cables are properly connected and power on the NVR.

TRENDnet Sentinel (Free Mobile App)

1. Download and Install Sentinel

Supported Operating Systems

Android (version 12 or above)
iOS (version 11 or above)



Sentinel iOS



Sentinel Android

2. Tap the "+" sign to add the NVR then tap Scan QR Code on the bottom of the devices.

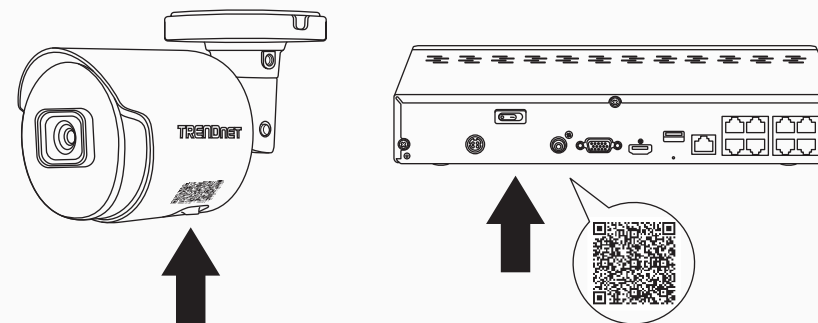

3. To activate a new NVR or camera you will need to create a password then tap on **Activate**.

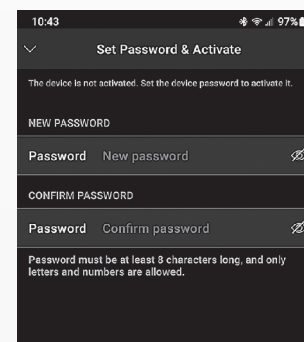

4. Once added you should see a live image from the NVR or camera.



1 Hard drive Installation

Skip to App installation if you do not have NVR.

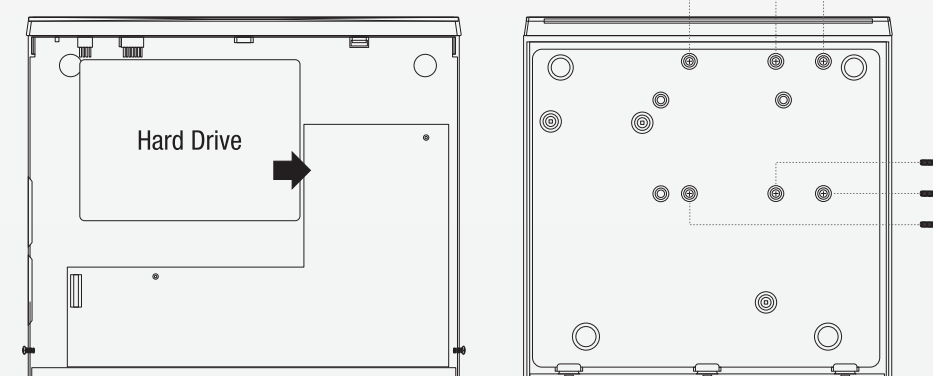

Mounting the Camera

Place the provided template label on the wall or ceiling. Drill holes at each marked position on the template. Make sure the drill bit matches the size of the holes on the template.

For TV-IP1514PI

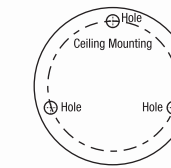

For TV-IP1515PI

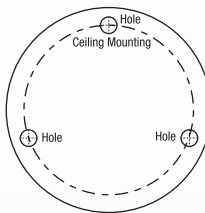

Bullet Camera Installation

Ceiling Mounting

Insert 3 anchors into the ceiling and affix the camera with 3 screws.

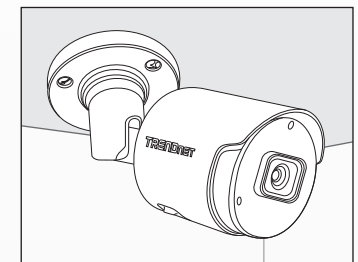
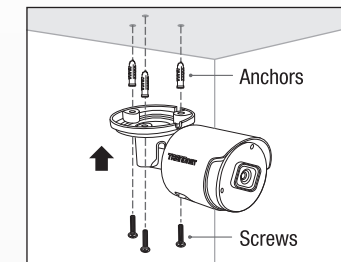

Wall Mounting

Insert 3 anchors into the wall and affix the camera with 3 screws.

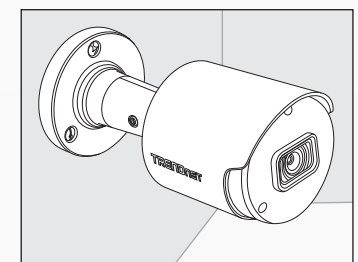
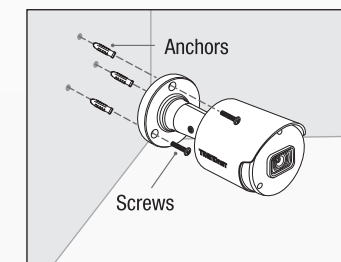

Mini Dome Camera Installation

Ceiling Mounting

Remove the fixed ring off the camera by rotating it down clockwise.

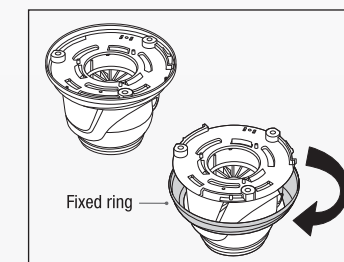

Insert 3 anchors into the ceiling and affix the camera with 3 screws.

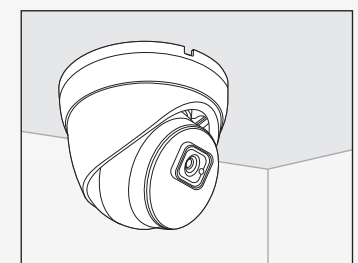
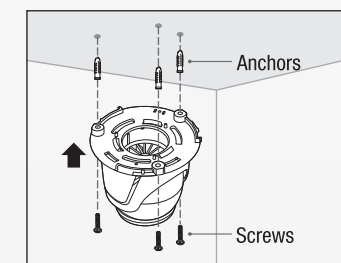

Adjust the camera to your desired angle then mount the fixed ring back into place by rotating it up counter-clockwise until locked

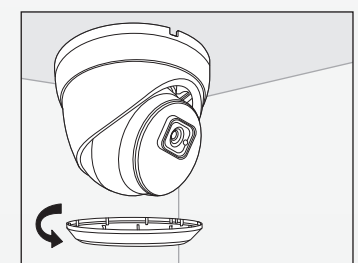
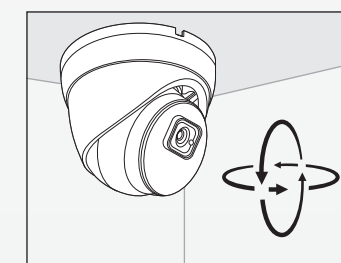

For additional configuration information, please refer to the user's guide.

Declaration of Conformity

TRENDNET

Manufacturer's Name and Address

TRENDnet, Inc.
20675 Manhattan Place
Torrance, CA 90501 USA

Zwolsestraat 156 2587 WB
The Hague The Netherlands



Product Information:

Model Number: TV-IP1514PI / TV-IP1515PI / TV-NVR1508

Product Name: Indoor/Outdoor 5MP H.265 WDR PoE IR Bullet Network Camera
Indoor/Outdoor 5MP H.265 WDR PoE IR Fixed Turret Network Camera
8-Channel H.265 4K (8MP) PoE NVR

Trade Name: TRENDnet

TRENDnet hereby declares that the product is in compliance with the essential requirements and other relevant provisions under our sole responsibility.

EMC EN 55032: 2015
EN 61000-3-2: 2019
EN 61000-3-3: 2013
EN 50130-4: 2011 + A1: 2014

This product is herewith confirmed to comply with the Directives.

Directives: EMC Directive 2014/30/EU
RoHS Directive 2011/65/EU
REACH Regulation (EC) No. 1907/2006

Person responsible for this declaration.

Place of Issue: Torrance, California, USA

Date: Apri, 2023

Title: VP of Technology

Name: Sonny Su

Signature:



Déclaration de conformité

TRENDNET

Nom et adresse du fabricant

TRENDnet, Inc.
20675 Manhattan Place
Torrance, CA 90501 USA

Zwolsestraat 156 2587 WB
The Hague The Netherlands



Nom du produit:

Modèle: TV-IP1514PI / TV-IP1515PI / TV-NVR1508

Détails du produit Caméra réseau Bullet IR PoE WDR H.265 5MP pour intérieur/extérieur
Caméra réseau Tourette fixe IR PoE WDR H.265 5 MP pour intérieur/extérieur
NVR PoE H.265 4K (8MP) à 8 canaux

Nom Commercial: TRENDnet

TRENDnet déclare par la présente que le produit est conforme aux exigences essentielles et aux autres dispositions pertinentes de la Directive en vertu de notre seule responsabilité.

CEM EN 55032: 2015
EN 61000-3-2: 2019
EN 61000-3-3: 2013
EN 50130-4: 2011 + A1: 2014

Ce produit est conforme à la directives suivante.

Directives: Directive CEM 2014/30/UE
Directive RoHS 2011/65/UE
REACH Règlement (CE) N° 1907/2006

Personne responsable de cette déclaration.

Lieu de délivrance: Torrance, California, USA

Date: 28 avril, 2023

Position: Vice-président de Technologie

Nom: Sonny Su

Signature:



Konformitätserklärung

TRENDNET

Name und Adresse des Herstellers

TRENDnet, Inc.
20675 Manhattan Place
Torrance, CA 90501 USA

Zwolsestraat 156 2587 WB
The Hague The Netherlands



Informationen zum Produkt

Modellnummer: TV-IP1514PI / TV-IP1515PI / TV-NVR1508

Produktname: Indoor/Outdoor 5 MP H.265 WDR PoE IR-Stift-Netzwerkamera
5MP H.265 WDR PoE IR feste Turm-Netzwerkamera für den Innen- und Außenbereich
8-Kanal H.265 4K (8MP) PoE NVR

Handelsname: TRENDnet

TRENDnet erklärt hiermit, dass das Produkt den grundlegenden Anforderungen und anderen relevanten Bestimmungen unter unserer alleinigen Verantwortung entspricht.

EMV EN 55032: 2015
EN 61000-3-2: 2019
EN 61000-3-3: 2013
EN 50130-4: 2011 + A1: 2014

Hiermit wird bestätigt, dass dieses Produkt den folgenden Richtlinien entspricht.

Richtlinien: EMV-Richtlinie 2014/30/EU
RoHS-Richtlinie 2011/65/EU
REACH-Verordnung (EG) Nr. 1907/2006

Für diese Erklärung verantwortliche Person.

Ort der Ausstellung: Torrance, California, USA

Datum: April 28, 2023

Titel: Vice President of Technology

Name: Sonny Su

Unterschrift:



Declaration of Conformity

TRENDNET

Manufacturer's Name and Address

TRENDnet, Inc.
20675 Manhattan Place
Torrance, CA 90501 USA



Authorized Representative:
Office: +44 (0) 1635 887 399
Unit 4 Rivermead Business Park,
Pipers Way, Thatcham, RG19 4EP England

Product Information:

Model Number: TV-IP1514PI / TV-IP1515PI / TV-NVR1508

Product Name: Indoor/Outdoor 5MP H.265 WDR PoE IR Bullet Network Camera
Indoor/Outdoor 5MP H.265 WDR PoE IR Fixed Turret Network Camera
8-Channel H.265 4K (8MP) PoE NVR

Trade Name: TRENDnet

TRENDnet hereby declares that the product is in compliance with the essential requirements and other relevant provisions under our sole responsibility.

EMC BS EN 55032: 2015
BS EN 61000-3-2: 2019
BS EN 61000-3-3: 2013
BS EN 50130-4: 2011 + A1: 2014

This product is herewith confirmed to comply with the Directives.

Directives: Electromagnetic Compatibility Regulations 2016
The Restriction of the Use of Certain Hazardous Substances in Electrical and Electronic Equipment Regulations 2012
The REACH Enforcement Regulations 2008 (as amended)

Person responsible for this declaration.

Place of Issue: Torrance, California, USA

Date: April 28, 2023

Title: VP of Technology

Name: Sonny Su

Signature:



Limited Warranty

TRENDnet warrants its products against defects in material and workmanship, under normal use and service. Specific warranty periods are listed on each of the respective product pages on the TRENDnet website.

Garantie Limitée

TRENDnet garantit ses produits contre les problèmes de matériel ou de fabrication, dans des conditions normales d'utilisation et de service. Les périodes de garanties précises sont mentionnées sur chacun des pages produits du site web de TRENDnet.

Eingeschränkte Garantie

TRENDnet gewährt eine Garantie für seine Produkte im Falle von Material- und Bearbeitungsdefekten, bei normaler Verwendung und Wartung. Spezielle Garantiezeiträume werden auf jeder Produktseite auf der Website von TRENDnet genannt.

Garantía limitada

TRENDnet garantiza que sus productos carecen de defectos en el material y la fabricación, en condiciones de uso y funcionamiento normales. Los periodos específicos de garantía figuran en cada una de las páginas de producto del sitio web de TRENDnet.

Ограниченная гарантия

Компания TRENDnet предоставляет гарантию на свои изделия от дефектов материалов и сборки при нормальном использовании и обслуживании. Конкретные гарантийные сроки указаны на странице каждого продукта на сайте компании TRENDnet.

Garantia Limitada

A TRENDnet garante seus produtos contra defeitos de material e mão de obra sob condições normais de uso e serviço. Os períodos de garantia específicos estão listados em cada uma das páginas dos respectivos produtos no site da TRENDnet.

Piiratud garantii

TRENDneti garantii hõlmab materjali- ja koostamisdefekte, mis ilmnevad toote tavapärasel kasutamisel. Garantiiaja täpne pikkus konkreitse toote puhul on leitav TRENDneti kodulehelt vastava toote infolehelt.

Garanzia limitata

TRENDnet garantisce i propri prodotti da difetti di materiali e manodopera, in condizioni di normale uso ed esercizio. I periodi di garanzia specifici sono elencati sulle rispettive pagine di prodotto sul sito TRENDnet.

English

<https://www.trendnet.com/qig/1095>



Certifications

This device complies with Part 15 of the FCC Rules. Operation is subject to the following two conditions:

- (1) This device may not cause harmful interference.
- (2) This device must accept any interference received, including interference that may cause undesired operation.



Waste electrical and electronic products must not be disposed of with household waste. Please recycle where facilities exist. Check with your Local Authority or Retailer for recycling advice.

Technical Support

If you have any questions regarding the product installation, please contact our Technical Support.

Toll free US/Canada: **1-866-845-3673**

Regional phone numbers available at www.trendnet.com/support

Product Warranty Registration

Please take a moment to register your product online. Go to TRENDnet's website at: www.trendnet.com/register

TRENDnet
20675 Manhattan Place
Torrance, CA 90501
USA

Applies to PoE Products Only: This product is to be connected only to PoE networks without routing to the outside plant.

Note

The Manufacturer is not responsible for any radio or TV interference caused by unauthorized modifications to this equipment. Such modifications could void the user's authority to operate the equipment.

Advertencia

En todos nuestros equipos se mencionan claramente las características del adaptador de alimentación necesario para su funcionamiento. El uso de un adaptador distinto al mencionado puede producir daños físicos y/o daños al equipo conectado. El adaptador de alimentación debe operar con voltaje y frecuencia de la energía eléctrica domiciliaria existente en el país o zona de instalación.



Power Input Range: 100-240V~, 50/60Hz, 6A
Power Output Rating: 54V/8.15A, 12V/2.5A
This lightning flash with arrowhead symbol within an equilateral triangle, is intended to alert the user to the presence of non-insulated "dangerous voltage" within the product's enclosure that may be of sufficient magnitude to constitute a risk of electric shock.



The exclamation point within an equilateral triangle is intended to alert the user to the presence of important operating and maintenance (servicing) instructions in the literature accompanying the appliance



WARNING: SHOCK HAZARD - DO NOT OPEN
AVIS: RISQUE DE CHOC ELECTRIQUE - NE PAS OUVRI
Note: The appliance inlet is served as disconnect device, the socket-outlet shall be installed near the equipment and shall be easily accessible