

TRENDnet®



Quick Installation Guide

PoE Web Smart Switch Series

Table of Contents

1 Português

1. Antes de Iniciar
2. Referência Rápida
3. Instalação de Hardware e Configuração

1. Antes de Iniciar

Conteúdo da Embalagem

- Guia de Instalação Rápida
- Cabo de alimentação (1,8 m / 6 pés)
- Kit para Montagem em Rack

Requisitos de Sistema

- Um computador com uma porta Ethernet e navegador da Web
- Rede cabeada

Equipamento Opcional

- Rack 19" Padrão EIA
- Módulos SFP Opcionais (exemplo: TE100-MGBFX, TEG-MGBSX, TEG-MGBS10, TEG-MGBS40, TEG-MGBS80, TEG-MGBS10D3, TEG-MGBS10D5, TEG-MGBS40D3, TEG-MGBS40D5)

2. Referência Rápida

PoE Camera



PoE Camera

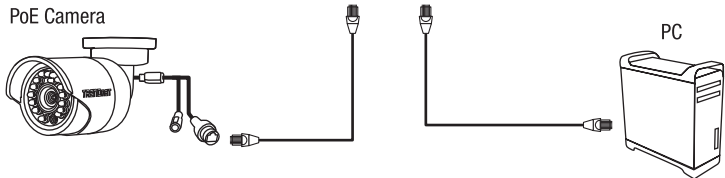

Nota: O modelo de switch pode ser diferente do exemplo mostrado abaixo.

3. Instalação de Hardware e Configuração

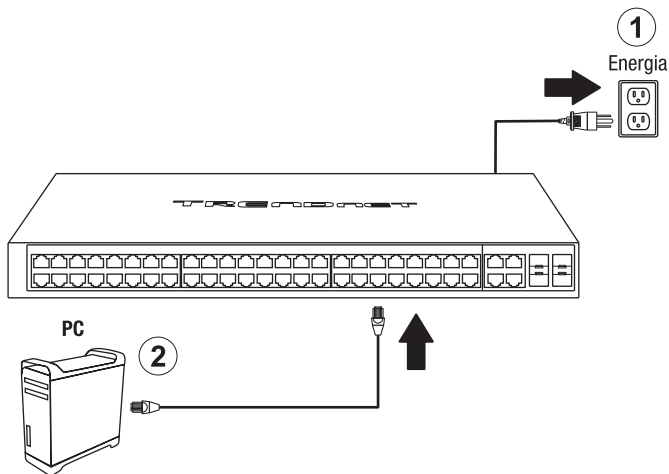

3. Colocar um endereço IP estático, na placa de rede do seu computador, na gama de Ips 192.168.10.x (por exemplo: 192.168.10.25) e colocar no campo da subnet mask 255.255.255.0.
4. Abra seu web browser, digite endereço IP do switch na barra de endereços e então pressione **Enter**. O endereço IP padrão é 192.168.10.200.

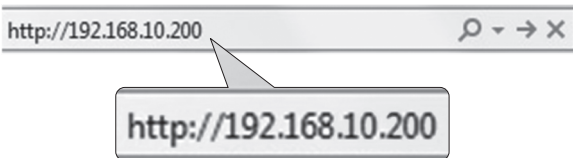

5. Entre com o **User Name** (Nome de Usuário) e **Password** (Senha) e então clique **LOGIN**.

Por padrão:

User Name(Nome de Usuário): **admin**

Password (Senha): **admin**

Nota: User Name (Nome do usuário) e Password (senha) são sensíveis a maiúsculas e minúsculas.

The screenshot shows a login form with two input fields. The first field is labeled 'User Name:' and contains the text 'admin'. The second field is labeled 'Password:' and contains six dots. Below the fields is a 'LOGIN' button. Callout boxes point to the 'admin' text in both fields and the 'LOGIN' button. A larger 'LOGIN' button is also shown to the right of the form.

6. Clique em **System** (Sistema) e depois clique em **IPv4 Setup** (Configuração IPv4).

7. Configure o switch para adequar-se aos requisitos de sua rede local. Clicar em **Apply**.

The screenshot shows two configuration pages side-by-side. The left page is titled 'Switch Info' and has a 'System' menu item highlighted with a callout box. The right page is titled 'IPv4 Setup' and has an 'IPv4 Setup' menu item highlighted with a callout box. The IPv4 Setup page contains the following fields: System MAC Address (00:01:02:03:04:05), System IP Address (192 . 168 . 10 . 200), System Subnet Mask (255 . 255 . 255 . 0), System Default Gateway (0 . 0 . 0 . 0), and System IP Mode (Static). An 'Apply' button is located at the bottom of the IPv4 Setup page, with a callout box pointing to it.

8. Clicar em **OK**.

The screenshot shows a 'WARNING' dialog box with a warning icon and the text: 'The management session will be disconnected. Use new IP address to connect to device.' Below the text are two buttons: 'OK' and 'Cancel'. The 'OK' button is highlighted with a callout box.

9. No painel do lado esquerdo, clique em **Ferramentas**, clique em **Configuração** e clique em **Salvar**.

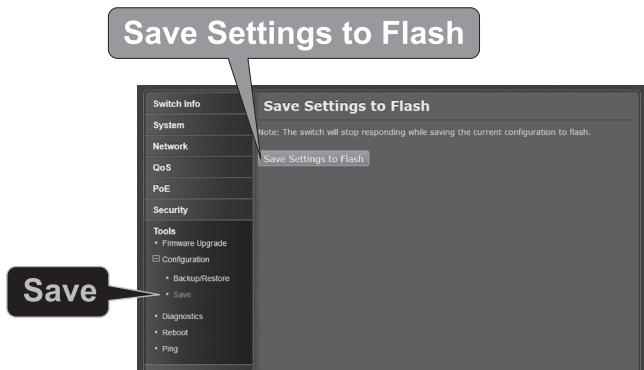

10. Clicar em **OK**.

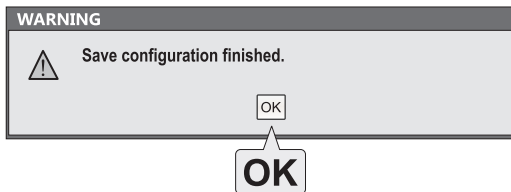

Nota:

1. Se você quiser descobrir facilmente todos os switches gerenciáveis da rede local, definir endereço IP, alterar senha, fazer upgrade para novo firmware, então instale o Utilitário de Gerenciamento de switches gerenciáveis via web. Siga os passos constantes do guia do usuário.
2. Para fazer o download da versão mais recente do guia do usuário, acesse: <http://www.trendnet.com/support> e selecione o **Switch Model** na lista suspensa Download do Produto.

UL Warning

- 1) Elevated Operating Ambient Temperature - If installed in a closed or multi-unit rack assembly, the operating ambient temperature of the rack environment may be greater than room ambient. Therefore, consideration should be given to installing the equipment in an environment compatible with the manufacturer's maximum rated ambient temperature (Tmra).
- 2) Reduced Air Flow - Installation of the equipment in a rack should be such that the amount of air flow required for safe operation of the equipment is not compromised.
- 3) Mechanical Loading - Mounting of the equipment in the rack should be such that a hazardous condition is not achieved due to uneven mechanical loading.
- 4) Circuit Overloading - Consideration should be given to the connection of the equipment to the supply circuit and the effect that overloading of circuits might have on over current protection and supply wiring. Appropriate consideration of equipment nameplate ratings should be used when addressing this concern.
- 5) Reliable Earthing - Reliable earthing of rack-mounted equipment should be maintained. Particular attention should be given to supply connections other than direct connections to the branch circuit (e.g., use of power strips).

Rack Installation

The Switch can be mounted in an EIA standard, 19-inch rack, which can be placed in a wiring closet with other equipment. To install, attach the mounting brackets to the switch's front panel (one on each side) and secure them with the screws provided.

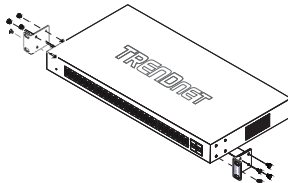

Attaching the mounting brackets to the Switch

Use the screws provided with the equipment rack to mount the Switch on the rack.

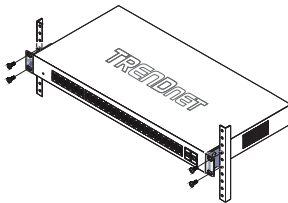

Installing the Switch in an equipment rack

Certifications

This device complies with Part 15 of the FCC Rules.

Operation is subject to the following two conditions:

- (1) This device may not cause harmful interference.
- (2) This device must accept any interference received.

Including interference that may cause undesired operation.



Waste electrical and electronic products must not be disposed of with household waste. Please recycle where facilities exist. Check with your Local Authority or Retailer for recycling advice.

FCC warning:

This equipment has been tested and found to comply with the limits for a Class A digital device, pursuant to part 15 of the FCC Rules. These limits are designed to provide reasonable protection against harmful interference when the equipment is operated in a commercial environment. This equipment generates, uses, and can radiate radio frequency energy and, if not installed and used in accordance with the instruction manual, may cause harmful interference to radio communications. Operation of this equipment in a residential area is likely to cause harmful interference in which case the user will be required to correct the interference at his own expense.

FCC Caution:

Any changes or modification not expressly approved by the party responsible for compliance could void the user's authority to operate this equipment.

Technical Support

If you have any questions regarding the product installation, please contact our Technical Support.

Toll free US/Canada: **1-855-373-4741**

Regional phone numbers available at www.trendnet.com/support

TRENDnet

20675 Manhattan Place
Torrance, CA 90501
USA

Applies to PoE Products Only: This product is to be connected only to PoE networks without routing to the outside plant.

Note

The Manufacturer is not responsible for any radio or TV interference caused by unauthorized modifications to this equipment. Such modifications could void the user's authority to operate the equipment.

Avertissement

S'applique uniquement aux produits PoE: Ce produit doit être raccordé qu'aux réseaux PoE sans routage vers l'installation extérieure.

Advertencia

En todos nuestros equipos se mencionan claramente las características del adaptador de alimentación necesario para su funcionamiento. El uso de un adaptador distinto al mencionado puede producir daños físicos y/o daños al equipo conectado. El adaptador de alimentación debe operar con voltaje y frecuencia de la energía eléctrica domiciliaria existente en el país o zona de instalación.

UL warning:

The equipment power supply cord shall be connected to a socket-outlet with earthing connection.

Le cordon d'alimentation de l'appareil doit être raccordé à une prise de courant avec mise à la terre.

Fiber product warning note:

If the Optical Transceiver doesn't ship with the unit, the user manual shall have the description as below or equivalent:

"This product is intended to be used with a UL Listed Optical Transceiver product, Rated DC3.3V, Laser Class I."

Laser warning note:

This product is intended to be used with a UL Listed Optical Transceiver product, Rated DC3.3V, Laser Class I.

Product Warranty Registration

Please take a moment to register your product online. Go to TRENDnet's website at:

www.trendnet.com/register