

**User's Guide**

**TRENDNET<sup>®</sup>**



**14 dBi WiFi 6 AX1200 Outdoor Directional PoE Access Point  
14 dBi WiFi 6 AX1200 Outdoor PoE Preconfigured  
Point-to-Point Bridge Kit**

**TEW-940APB0 / TEW-940APB02K**

## Contents

- Product Overview .....1**
  - Package Contents ..... 1
  - Features ..... 1
  - Product Hardware Features..... 3
- Primary Product Application.....5**
  - Application Diagram ..... 5
- Minimum Installation Requirements .....6**
- Wireless Installation Tips .....6**
- Model Differences .....7**
  - TEW-940APBO ..... 7
  - TEW-940APBO2K ..... 7
- TEW-940APBO Setup & Installation .....8**
  - Note the WiFi MAC Addresses..... **Error! Bookmark not defined.**
  - TEW-940APBO #1 ..... **Error! Bookmark not defined.**
  - TEW-940APBO #2 ..... 14
  - Confirm Connectivity ..... 15
  - Pole Mount Installation ..... **Error! Bookmark not defined.**
  - Completed Installation Reference ..... **Error! Bookmark not defined.**
- TEW-940APBO2K Setup and Installation .....17**
  - Setup and Confirm Connectivity ..... 18
  - Pole Mount Installation ..... 21
  - Completed Installation Reference ..... 22
- Channel Access Method .....23**
  - Carrier-Sense Multiple Access with Collision Avoidance (CSMA/CA) ..... 23
  - Time-Division Multiple Access (TDMA)..... **Error! Bookmark not defined.**

- Application Modes .....24**
  - Access Point (AP) ..... 24
  - Client Bridge ..... 24
  - WDS Access Point (WiFi Distribution System) ..... **Error! Bookmark not defined.**
  - WDS Station..... **Error! Bookmark not defined.**
  - WDS Bridge (CSMA ONLY) ..... **Error! Bookmark not defined.**
- Accessing your access point management page .....26**
  - Access your access point management page ..... 26
- Overview .....27**
  - Device Status ..... 27
  - Connections ..... 28
  - Real-time ..... **Error! Bookmark not defined.**
- Network .....Error! Bookmark not defined.**
  - Basic..... **Error! Bookmark not defined.**
  - Wireless ..... **Error! Bookmark not defined.**
- Management .....Error! Bookmark not defined.**
  - Advanced ..... **Error! Bookmark not defined.**
  - Time Zone ..... **Error! Bookmark not defined.**
  - WiFi Scheduler..... **Error! Bookmark not defined.**
  - Tools ..... **Error! Bookmark not defined.**
- System Manager .....Error! Bookmark not defined.**
  - Account..... **Error! Bookmark not defined.**
  - Firmware ..... **Error! Bookmark not defined.**
  - System Log..... **Error! Bookmark not defined.**
  - Log Out ..... **Error! Bookmark not defined.**
- Technical Specifications .....45**
- Appendix .....48**

## Product Overview

**TEW-940APBO****TEW-940APBO2K**

### Package Contents

**TEW-940APBO** package includes:

- TEW-940APBO
- Quick Installation Guide
- Proprietary/Passive PoE injector (54V DC, 0.6A)
- Mounting hardware

**TEW-940APBO2K** package includes:

- 2 x TEW-940APBO
- Quick Installation Guide
- Proprietary/Passive PoE injectors (54V DC, 0.6A)
- Mounting hardware

If any package contents are missing or damaged, please contact the retail store, online retailer, or reseller/distributor from which the product was purchased.

### Features

TRENDnet's 14 dBi WiFi 6 AX1200 Outdoor Directional PoE Access Point, model TEW-940APBO, is designed for point-to-point WiFi bridging applications. The 5GHz outdoor wireless access point supports wireless point-to-point installation scenarios with Access Point, Client Bridge, and Repeater modes. The IP55 rated housing is designed for outdoor environments, and includes wall and pole mounting hardware. Faster speeds are possible on this WiFi 6 access point with OFDMA and MU-MIMO technologies. MU-MIMO technology processes multiple data streams simultaneously, increasing real-time WiFi performance on the outdoor wireless access point when multiple devices access the network.

TRENDnet's 14 dBi WiFi 6 AX1200 Outdoor PoE Preconfigured Point-to-Point Bridge Kit, model TEW-940APBO2K, provides reliable, long-range wireless AX1200 point-to-point connectivity. This preconfigured 5GHz outdoor WiFi 6 bridge kit provides installers the simplest way to create a long-distance wireless point-to-point bridge. The outdoor WiFi 6 bridge kit conveniently links two locations together with WiFi 6 AX1200 speed and performance. Faster speeds are possible with this outdoor point-to-point WiFi 6 bridge kit with OFDMA and MU-MIMO technologies. MU-MIMO technology processes multiple data streams simultaneously, increasing real-time WiFi performance on the outdoor wireless access point when multiple devices access the network. The IP55 rated housing is designed for outdoor environments, and includes wall and pole mounting hardware.

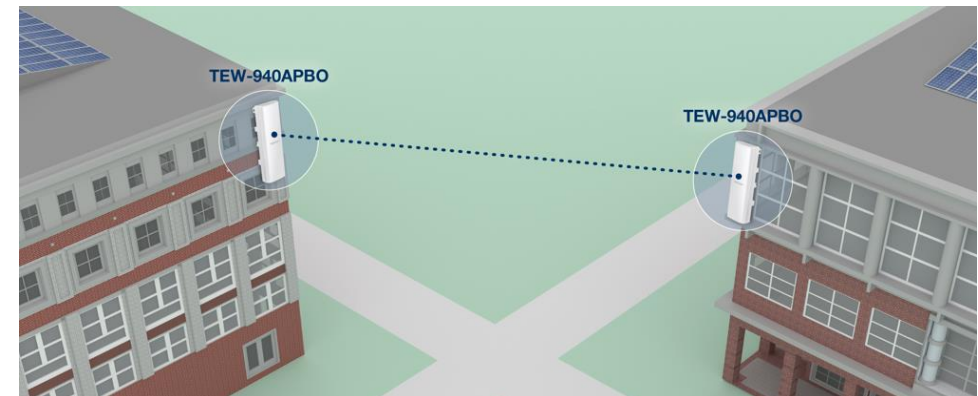

### Preconfigured Kit (*TEW-940APBO2K ONLY*)

Reduce installation and setup time with this preconfigured and pre-encrypted outdoor long-range WiFi 6 access points

### Wireless Modes

Supports Access Point, Client Bridge, and Repeater modes

### WiFi AX1200 (5GHz)

Compliant with 802.11ax/n/ac 5GHz technology with data rates up to 1.2Gbps\*

### Outdoor Rated

Durable enclosure with an IP55 outdoor weather rating

### Directional Antenna

14 dBi directional antenna

### PoE Power Adapter

Proprietary PoE power adapter(s) included

### Encrypted Wireless

Support for wireless encryption of up to WPA3

### Mounting Hardware

Pole and wall mount hardware included

### LED Indicators

LEDs convey wireless connection quality for ease of installation

#### Disclaimer

\* Effective wireless coverage may vary depending on the wireless device's output power, antenna gain, antenna alignment, receiving sensitivity, and radio interference. Additionally, environmental factors such as weather conditions, physical obstacles, and other considerations may affect performance. For optimal results, we recommended consulting a professional installer for site survey, safety precautions, and proper installation.

\*\* The distance listed in the specification is based on internal wireless connectivity between two TEW-940APBO units with consideration to acceptable data transmission rates performance throughput. Actual achievable connectivity and performance throughput may vary based on environmental factors in the installed locations.

**Product Hardware Features**

Front View



IP55 Weather Rated Housing with built-in directional sector antenna

Back View (Closed)

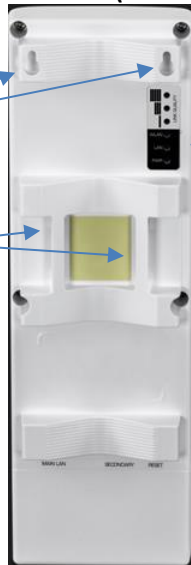

Wall Mount Holes

Pole Mount Holes

LED indicators

Bottom View (Open)



IP55 weather rated

Reset Button

Main LAN Port (PoE)

Secondary LAN Port (Non-PoE)

- **Main LAN (PoE) Port** – This Gigabit Ethernet interface will be used to provide both power and network data connectivity to the access point from the PoE port on the proprietary PoE injector.
- **Secondary LAN Port (Non-PoE)** – This Gigabit Ethernet interface is a secondary gigabit LAN port that can also be used to also access the access point management interface. The Main LAN port and Secondary LAN port are bridged.
- **Reset Button** – The reset button resets the access point to factory default settings. Using a paper clip, push and hold the reset button for 15 sec. and release. The LEDs will flash when the device reset has been initiated.
- **PoE Power Injector Reset Button** – The included PoE injector also has a reset button to reset the access point to factory default. Using a paper clip, push and hold the reset button for 15 sec. and release. The LEDs will flash when the device reset has been initiated.

**LED Description**

- **Power (PWR) LED** – When the LED is ON and, this will indicate that the device is receiving power and OFF if the device is not receiving power.
- **LAN LED** – When the LED is ON, this indicates an active network connection from the LAN port of the PoE injector. When the LED is BLINKING, this indicates data is being transmitted or received on the LAN1 port. The LED is OFF when there is no active network connection to the LAN port on the PoE injector.
- **WLAN LED** – When the LED is ON, the wireless radio on the device is on. When the LED is OFF, the wireless radio on the device has been disabled.

LED	Status	Description
PWR	Solid Green	Device is receiving power
LAN	Solid Green	1G Data link established
	Solid Orange	100M/10M Data link established
	Blinking	Data transmission
WLAN	Solid Green	5GHz radio is enabled
	Blinking	Data transmission
Link Quality (Only functions if TEW-940APBO is in Client Bridge operation mode)	Solid Green (Best)	When connected to remote wireless access point in client bridge mode, indicates wireless connection quality.
	Solid Orange (Better)	
	Solid Red (Good)	

- **Link Quality LEDs (Client Bridge Mode only)** – These LEDs will indicate the wireless connection quality to the remote access point when configured in Client Bridge mode.



Proprietary PoE Injector (54V DC, 0.6A)



**Important Note:**

The access point **does not** support standard IEEE 802.3at/af PoE/PoE+. Only the included proprietary PoE injector may be used to supply power to the access point. For safety, use only the included PoE injector to supply power to the access point.

- Connect the included power cord to this input and the other end into an AC power source to supply power to the injector.
- **PoE** – Connect an Ethernet RJ-45 cable to this port and the other side to the device Main LAN port (PoE) to supply power to the access point. Please note that the RJ-45 Ethernet cable between the proprietary PoE injector and the LAN1 (PoE) port of the access points supports a maximum length of up to 60 m (197 ft.). RJ-45 Ethernet cables longer than the maximum length specified may result in insufficient power to the device, intermittent connectivity/power loss, and unstable physical link.
- **LAN** – Connect an Ethernet RJ-45 cable to this port and connect the other to your Gigabit network or directly to a computer for initial device setup.



## Primary Product Application

The intended purpose and application for this product is to extend network connectivity across long physical distances outside of an area or building that lacks local connectivity using point-to-point wireless bridge capability using 802.11 standards. Two access points configured in point-to-point bridge mode and can connect/link the two physical locations or buildings together through an encrypted wireless connection. The basic installation will only cover the primary application of point to point wireless connectivity one access using standard Access Point Mode and the other access point using Client Bridge Mode with WPA2/WPA3 AES encryption for security.

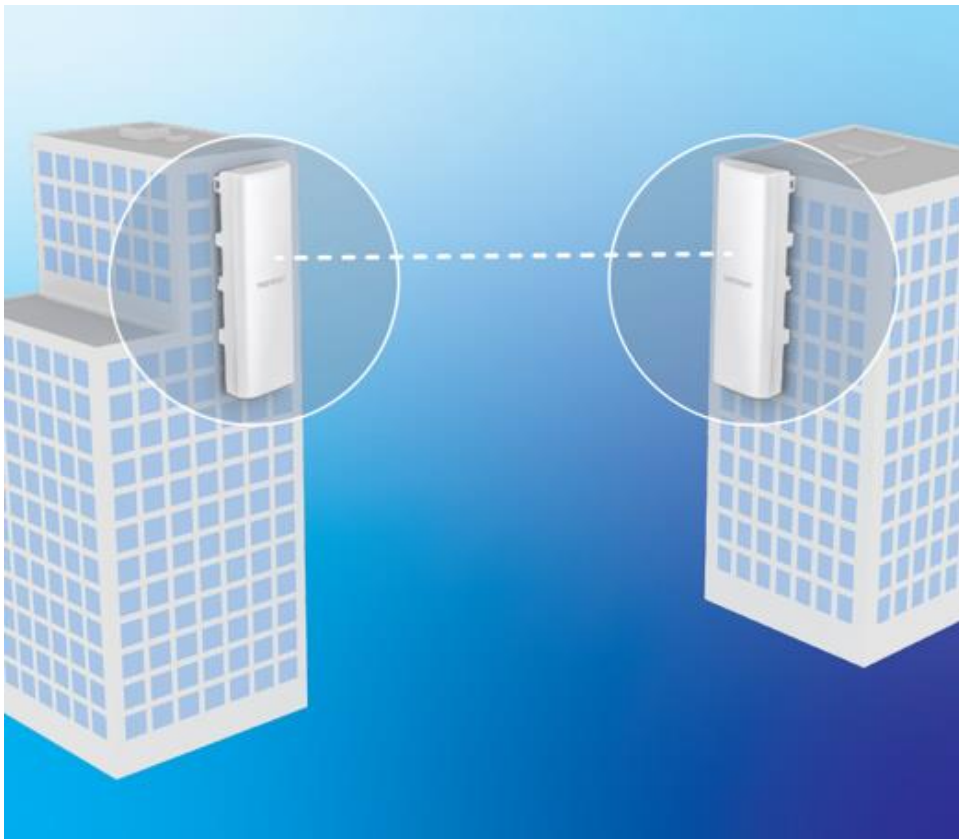

## Application Diagram

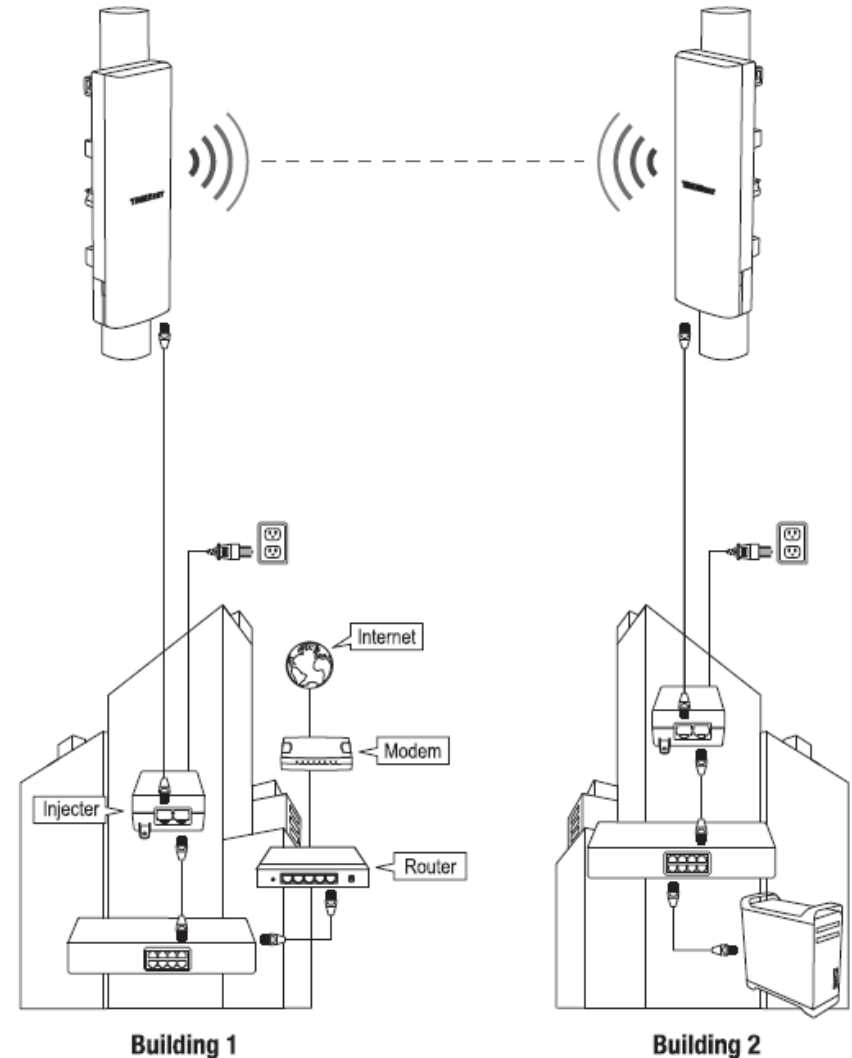

The example application displays two TEW-940APBO access points establishing a wireless link between each other, one configured in Access point mode and the other access point in Client Bridge mode; allowing for network connectivity between two buildings over a point-to-point wireless link.

## Minimum Installation Requirements

- Computer with RJ-45 Ethernet port and web browser
- 2 x RJ-45 Ethernet cables (not included) per TEW-640APBO
- Additional TRENDnet TEW-940APBO or TEW-941APBO (For TEW-940APBO single unit only, TEW-940APBO2K model includes two preconfigured units)

### For mounting only

- Standard (slotted) driver bit with power drill or screw driver for fastening metal mounting clamp(s) with pole installation
- Phillips (cross-head) driver bit with power drill or screw driver for wall mounting installation
- Drill bits for wall mounting installation only

## Wireless Installation Tips

There are a number of factors that can impact the range of wireless devices.

1. Adjust your wireless devices so that the signal is traveling in a straight path, rather than at an angle. The more material the signal has to pass through the more signal you will lose.
2. Keep the number of obstructions to a minimum. Each obstruction can reduce the range of a wireless device. Position the wireless devices in a manner that will minimize the amount of obstructions between them.
3. Building materials can have a large impact on your wireless signal. In an indoor environment, try to position the wireless devices so that the signal passes through less dense material such as dry wall. Dense materials like metal, solid wood, glass or even furniture may block or degrade the signal.
4. Antenna orientation can also have a large impact on your wireless signal. Use the wireless adapter's site survey tool to determine the best antenna orientation for your wireless devices.
5. Interference from devices that produce RF (radio frequency) noise can also impact your signal. Position your wireless devices away from anything that generates RF noise, such as microwaves, radios and baby monitors.

If you are still experiencing low or no signal consider repositioning the wireless devices or installing additional access points. The use of higher gain antennas may also provide the necessary coverage depending on the environment. Please note to use the wireless connection quality indicators during installation to determine the optimal positioning when mounting your access points.



## Model Differences

### TEW-940APBO

#### Single Unit Model

The single access point requires another TRENDnet TEW-940APBO or a TEW-941APBO to point-to-point wireless bridge.

#### Important Note:

Purchasing this model requires the access points to be properly configured to establish the wireless link/bridged connection to each other and verifying connectivity first before mounting the access points in their desired locations.

#### Single Unit Default Settings

LAN IP Address: 192.168.10.100

LAN Subnet Mask: 255.255.255.0

Mode: Access Point (AP) Mode

WPA3/WPA2-Mixed Encryption Key: <predefined>

User: admin

Password: admin

### TEW-940APBO2K

#### Preconfigured Bridge Kit Model

The two access points in the kit model are preconfigured to establish a point-to-point wireless bridge connection to each other (one configured in access point mode and the other configured in client bridge mode) using a unique WPA3/WPA2 encryption key. For convenience, a unique predefined administrator password is also assigned. The predefined WPA3/WPA2 encryption key and administrator password can be found on the included wireless settings sticker or on the device label.

#### Important Note:

Purchasing this model does not require any additional configuration to establish the wireless link/bridged connection between the two access points but it is strongly recommended that you verify connectivity first between the two access points first before mounting them in their desired locations.

#### Preconfigured Kit Default Settings

TEW-940APBO #1

LAN IP Address: 192.168.10.50

LAN Subnet Mask: 255.255.255.0

Mode: Access Point

WPA2/WPA3 Key: <predefined>

User: admin

Password: <predefined>

TEW-940APBO #2

LAN IP Address: 192.168.10.51

LAN Subnet Mask: 255.255.255.0

Mode: Client Bridge

WPA2/WPA3 Key: <predefined>

User: admin

Password: <predefined>

#### Wireless Setting Stickers for Kit TEW-940APBO2K

#### Unit 1

**TRENDNET**<sup>®</sup>

Ap1

Model: TEW-940APBO /A

IP Address: 192.168.10.50

Subnet Mask: 255.255.255.0

User Name: admin

Password: XXXXXXXX

Ap1 Mode: Access Point

Ap1 SSID: TRENDnet940\_XXXX

Ap1 WPA2 Key: 940XXXXXXXXX

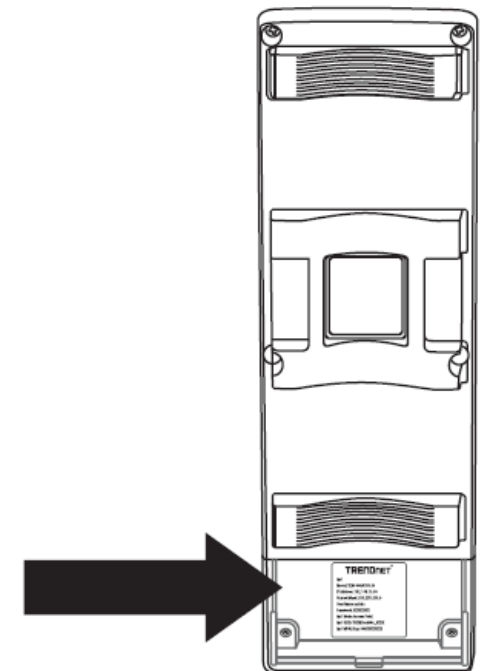

**Unit 2**

**TRENDnet**<sup>®</sup>  
 Ap2  
 Model: TEW-940APBO /A  
 IP Address: 192.168.10.51  
 Subnet Mask: 255.255.255.0  
 User Name: admin  
 Password: XXXXXXXX  
 Ap1 Mode: Access Point  
 Ap1 SSID: TRENDnet940\_XXXX  
 Ap1 WPA2 Key: 940XXXXXXXXX

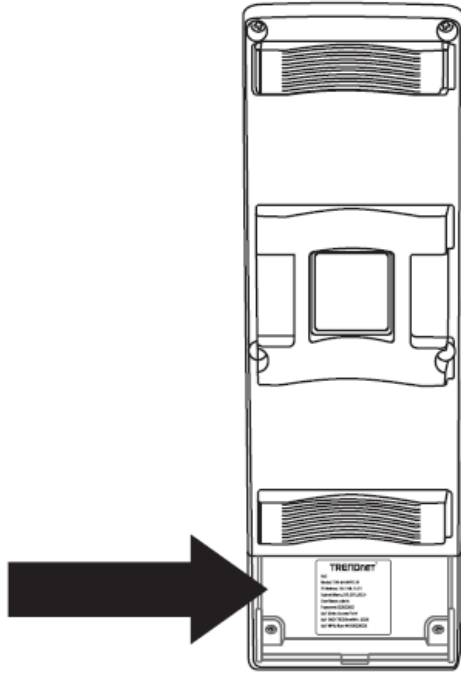

**TEW-940APBO Setup & Installation**

The following installation procedure assumes you are setting up and installing two TRENDnet **TEW-940APBO** access points in **Access Point/Client Bridge** point-to-point configuration.

**Note:** This example installation procedure will be demonstrated using the following example network information:

*Example Router Settings:*

Router/Default Gateway IP Address: 192.168.10.1  
 Primary DNS: 192.168.10.1  
 Subnet Mask: 255.255.255.0

Using the above information, we will configure the TEW-940APBO access points will be configured with the following settings:

TEW-940APBO #1	TEW-940APBO #2
----------------	----------------

<b>IP Address</b>	192.168.10.50	192.168.10.51
<b>Netmask (Subnet Mask)</b>	255.255.255.0	255.255.255.0
<b>IP Gateway (Default Gateway)</b>	192.168.10.1	192.168.10.1
<b>Primary DNS</b>	192.168.10.1	192.168.10.1
<b>Mode</b>	Access Point	Client Bridge
<b>WDS Encryption</b>	WPA2/WPA3	WPA2/WPA3

**Note:** In this installation procedure example, we will assume the WiFi MAC addresses:

	<b>TEW-940APBO #1</b>	<b>TEW-940APBO #2</b>
<b>WiFi MAC Address</b>	00:11:22:33:44:00	00:11:22:33:44:11

1. Remove the cover of the access point by pulling and holding the bottom tab at the bottom of the access point and from the back side, slide the cover below away from the access point.

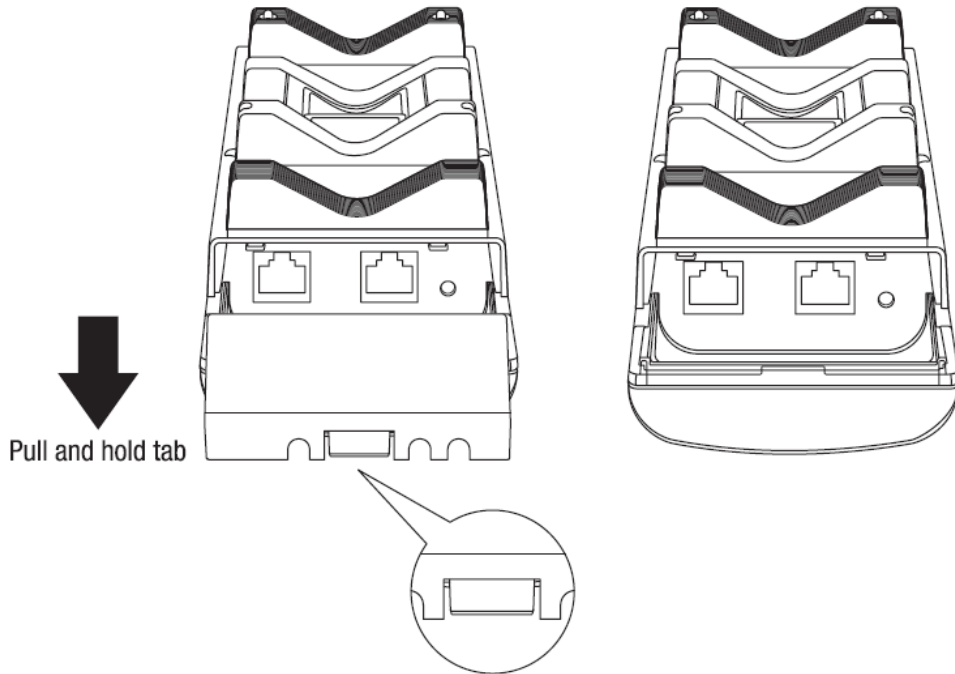

**Note:** By default, the TEW-940APBO access points are preconfigured to establish a point-to-point wireless bridge connection between each other using a unique predefined WPA3-SAE AES encryption key. For convenience, a unique predefined admin password has already been assigned to both access points. You can find the preconfigured access point settings on the device label beneath the cover where the Ethernet ports are located. No additional configuration is required.

**TEW-940APBO #1**

- Using a network cable, connect one end of the cable to the **Main LAN port (PoE)**. **Note:** The network cable length cannot exceed 60m (197 ft.). The package contents includes seals for the unused cable guide openings and tab for weather proofing in the final installation.

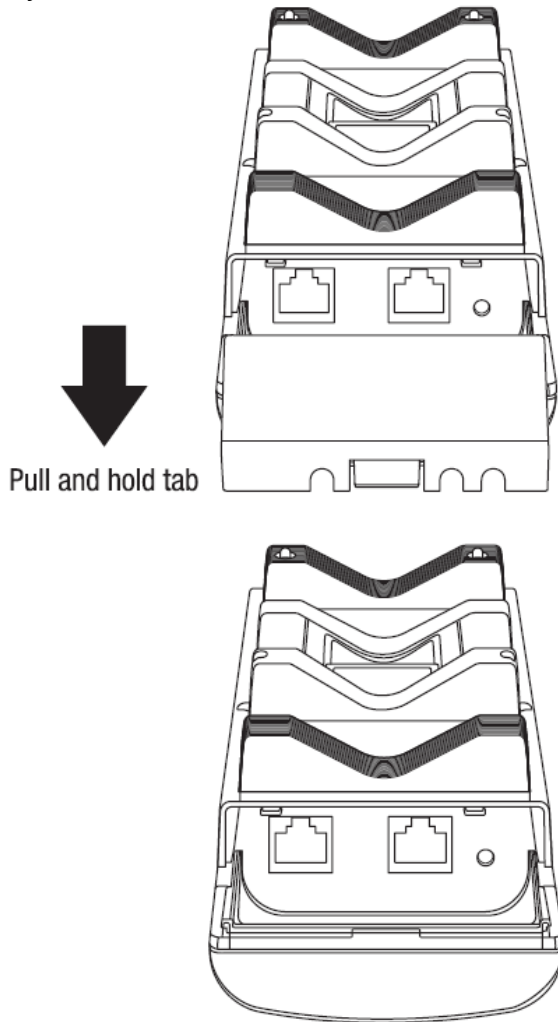

- Connect the other end of the network cable to the **PoE** port on the included PoE injector. **Note:** The network cable length cannot exceed 60m (197 ft.).
- Using another network cable, connect one end to the **LAN** port on the included PoE injector.
- Connect the other end of the network cable to your computer's Ethernet port.
- Attach the power cord to the PoE injector and plug the connected power cord into a power outlet.
- Confirm the device is powered on through the LED indicators. Please refer to the LED definition table below.

LED	Status	Description
PWR	Solid Green	Device is receiving power
LAN	Solid Green	1G Data link established
	Solid Orange	100M/10M Data link established
	Blinking	Data transmission
WLAN	Solid Green	5GHz radio is enabled
	Blinking	Data transmission
Link Quality (Only functions if TEW-940APBO is in Client Bridge operation mode)	Solid Green (Best)	When connected to remote wireless access point in client bridge mode, indicates wireless connection quality.
	Solid Orange (Better)	
	Solid Red (Good)	

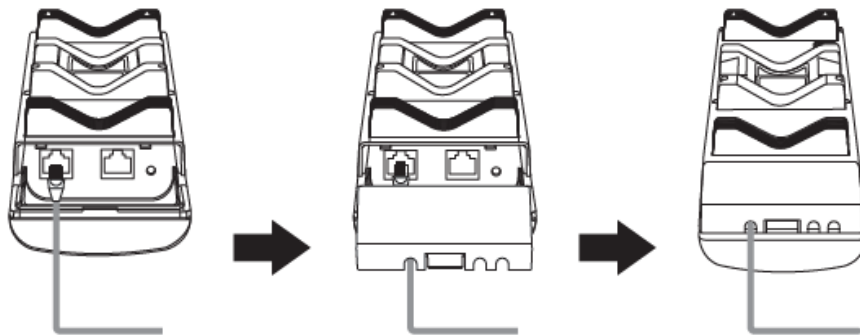
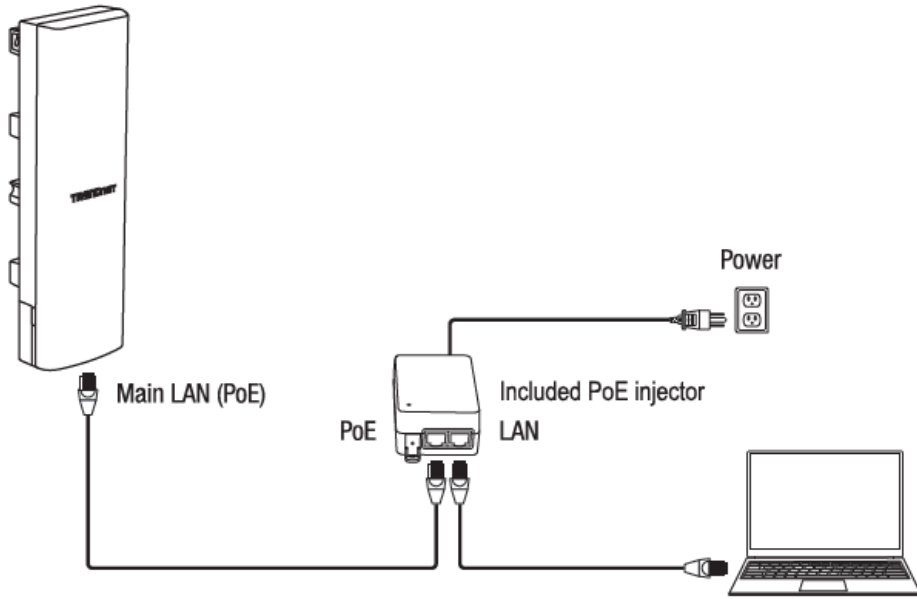

- Assign a static IP address to your computer's network adapter in the subnet of 192.168.10.x (e.g. 192.168.10.10) and subnet mask of 255.255.255.0.

**Note:** For information on how to statically assign your IP address, see the Appendix section.

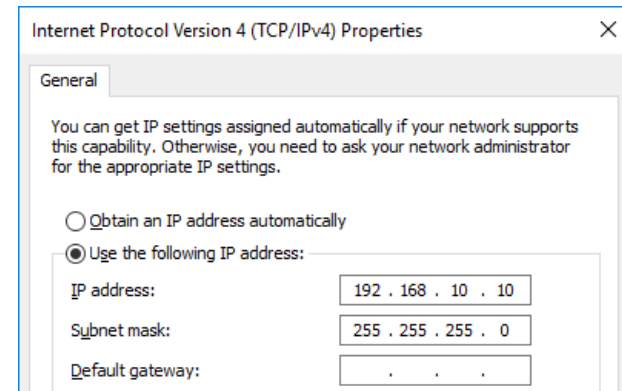

- Open your web browser and type in the default IP address of the access point in the address bar, then press **Enter**. The default IP address of the access point is 192.168.10.100.



9. When prompted, login to the access point management page using the default user name and password settings.
  - User Name: admin
  - Password: admin

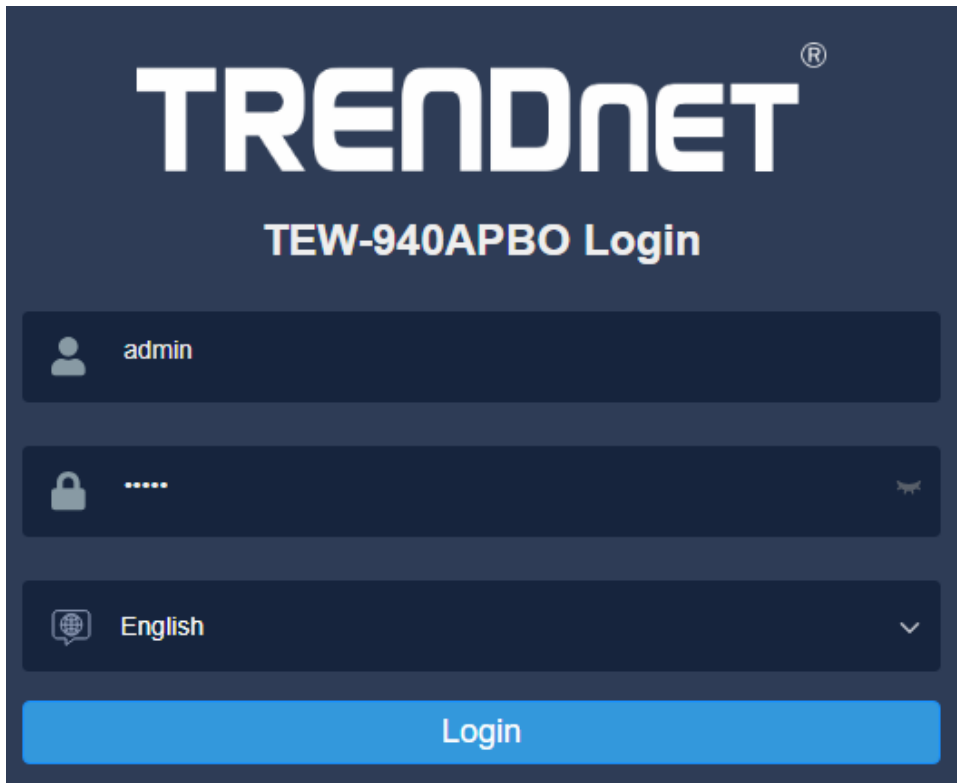

10. Enter the new admin password settings in the fields provided and click **Apply** to change the default admin password.

**Note:** You will immediately need to log into the access point configuration page with the new password settings.

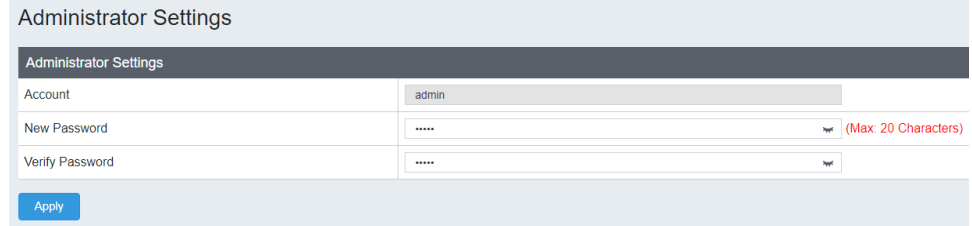

11. In the left navigation menu, click **System** and **IP Settings**.

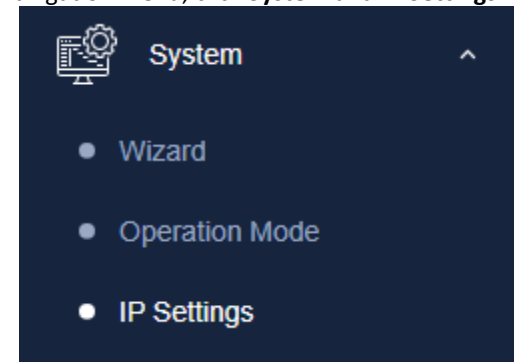

- Click the **Connection Type** drop-down list and select **STATIC**, and enter the IP address **192.168.10.50**, Subnet Mask **255.255.255.0**, Default Gateway **192.168.10.1**, and Primary DNS Server **192.168.10.1**, then click **Apply**.

**LAN Connection Type**

Connection Type	STATIC
-----------------	--------

**LAN Interface Setting**

IP Address	192.168.10.50
Subnet Mask	255.255.255.0
Default Gateway	192.168.10.1

**DNS Server Setting**

Primary DNS Server	192.168.10.1
Secondary DNS Server	

Apply
Cancel

- In the left navigation menu, click **Wireless 5GHz** and **Wireless Network**.

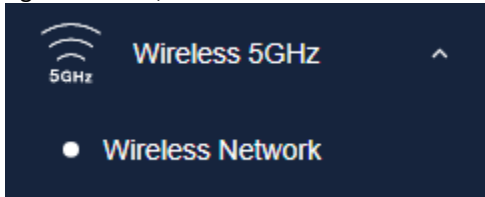

- For the first entry that is pre-configured, click **Edit** in the right column.

Index	Status	SSID	Security Mode	Password	Edit / Add
1	Enabled	TRENDnet940_C172	WPA3-SAC Mixed AES	*****	<span style="background-color: #007bff; color: white; padding: 2px 5px; border-radius: 3px;">Edit</span>

- At the top under Wireless Settings, you can change the SSID in the **SSID** field.  
**Note:** Please note the SSID as it will be needed to connect the second access point to create the wireless bridge.

**Wireless Settings**

SSID	TRENDnet940_C172
------	------------------

- Under the Wireless Security section, click the drop-down to select the wireless security mode to use.  
**Note:** For general wireless client compatibility, it is recommended to use the highest supported WPA3-Personal Mixed AES.

**Wireless Security**

Security Mode	WPA3-Personal Mixed
<b>WPA</b>	<ul style="list-style-type: none"> <li>Disabled</li> <li>WPA2-Personal</li> <li>WPA2-Personal Mixed</li> <li>WPA3-Personal</li> <li style="background-color: #007bff; color: white;">WPA3-Personal Mixed</li> <li>OWE</li> <li>WPA-Enterprise</li> <li>WPA2-Enterprise</li> <li>WPA2-Enterprise Mixed</li> </ul>
WPA Cipher	
Pre-Shared Key	

- Enter the WiFi password or Pre-Shared Key in the **Pre-Shared Key** field and click **Apply** at the bottom of the page. (8-63 alphanumeric characters)  
**Note:** Please make note of the WiFi password or pre-shared key assigned as it will be used for the configuration of the second access point to make the wireless bridge.

**WPA**

WPA Cipher	AES
Pre-Shared Key	*****
Key Update Interval	3600 Seconds

- In the top right main menu, click on the **Save button** to commit the configuration changes.



**TEW-940APBO #2**

When configuring TEW-940APBO #2, **repeat all steps up to step 11** in previous section when configuring [TEW-940APBO #1](#).

Assuming steps 1-11 from previous section....

- Under the IPv4 Settings section, select **Static IP** and enter the IP Address **192.168.10.51**, Subnet Mask **255.255.255.0**, Default Gateway **192.168.10.1**, and Primary DNS **192.168.10.1**, then click **Apply** at the bottom of the page.

LAN Connection Type	
Connection Type	STATIC

LAN Interface Setting	
IP Address	192.168.10.51
Subnet Mask	255.255.255.0
Default Gateway	192.168.10.1

DNS Server Setting	
Primary DNS Server	192.168.10.1
Secondary DNS Server	

Apply Cancel

- In the left navigation menu, click **System** and **Operation Mode**.

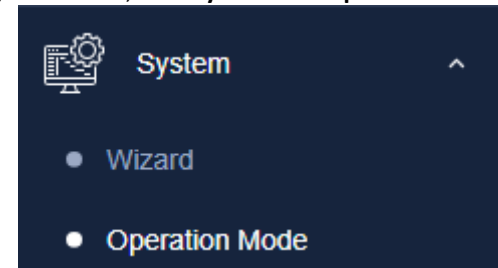

- Click the **Operation Mode** drop-down list and select **Client Bridge**, then click **Apply**.

Device Name : TEW-940APBO	
5GHz Operation Mode	Client Bridge

Apply Cancel

- In the left navigation menu, click **Wireless 5GHz** and **Wireless Network**.

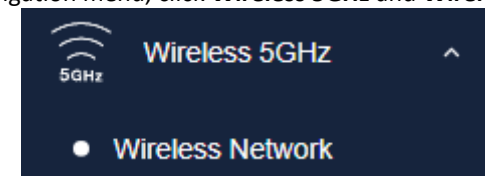

- In the Wireless Network section, click on **Site Survey**.

**Wireless Network**

Wireless Mode: 802.11 ax

SSID: Target SSID Site Survey

Preferred BSSID: Disabled

6. In the Site Survey List, find the SSID configured on the first TEW-940APBO access point and select it by clicking on the entry.

SSID	BSSID	Channel	Signal Level	Type	Security	Mode
TRENDnet940_C172	00:03:7F:12:69:69	153	-22 dbm	11AXA-HEB0	WPA3-SAE Mixed	AP
pm-940ab2-5GHic11AX	D8:EB:97:34:08:40	161	-33 dbm	11AXA-HEB0	WPA3-SAE Mixed	AP

7. The detailed of the selected SSID will be entered into the wireless section automatically. Under the Wireless Security section under WPA, enter the **Pre-Shared Key** configured on the first access point and click **Apply**.

**Wireless Network**

Wireless Mode: 802.11 ax

SSID: TRENDnet940\_C172 Site Survey

Preferred BSSID: Enabled

00:03:7F:12:69:69

Note: Enter the SSID/Wireless Network Name of the wireless network you would like to connect to in the field below or click Site Survey to scan for the available wireless

**Wireless Security**

Security Mode: WPA3-Personal Mixed

**WPA**

WPA Cipher: AES

Pre-Shared Key: .....

Apply Cancel



8. In the top right main menu, click on the **Save button** to commit the configuration changes.

### Confirm Connectivity

1. Leave your computer connected to TEW-940APBO #2 and keep the access point management page open.
2. Make sure both TEW-940APBO #1 and TEW-940APBO #2 access point are powered on and approximately 15 ft. (5 m) apart from one another with the front of access points directly facing each other.

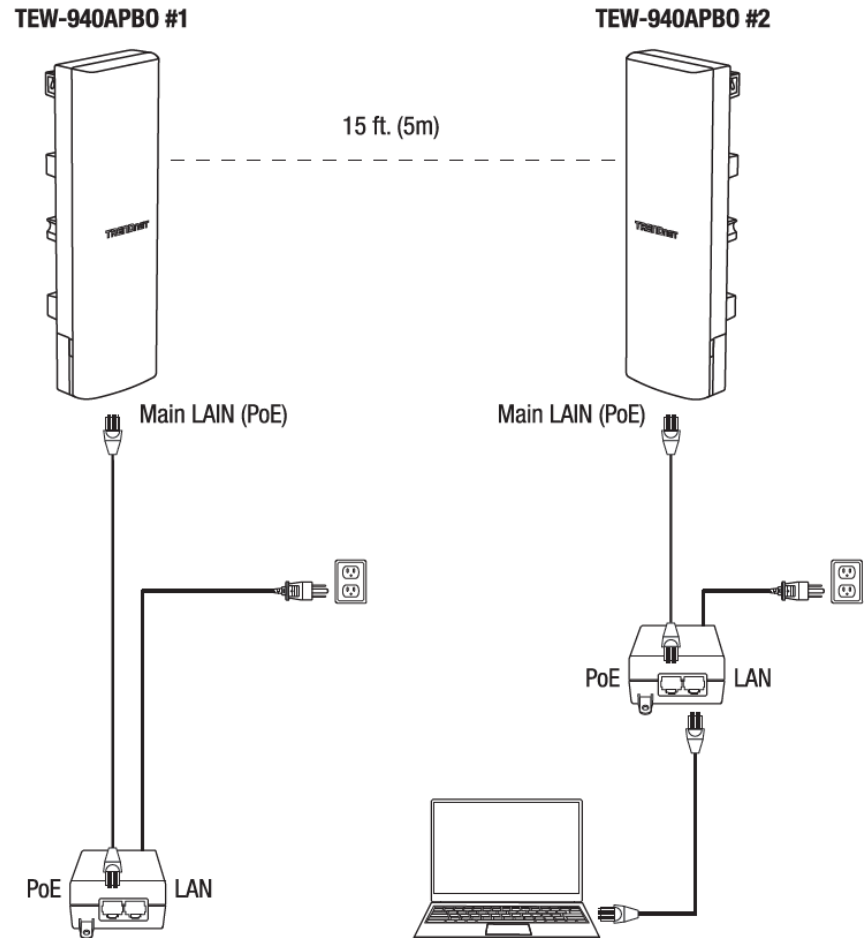

- To verify connectivity, in the TEW-940APBO #2 access point management page, in the left navigation menu, click **Management** and click **Diagnostics**.

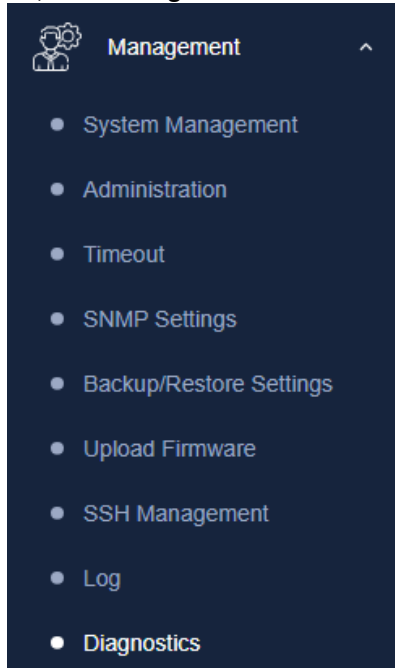

- Under the Ping Test Parameter section, enter the IP address **192.168.10.50**. Then click **Ping**.

### Diagnostics

Ping Test Parameter

IP Address	192.168.10.50
Packet Length	64
Number of Pings	4

Ping

- Ping replies and 0% packet loss will indicate a successful ping result to across the point-to-point wireless bridge has been established between the two access points as shown below.

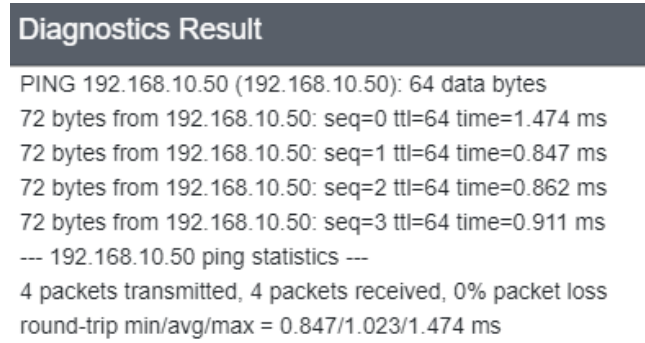

**Note:** If the connectivity test fails, wait for about 1 minute and try again. Make sure there are no obstacles between two access points and that they are not too close together.

## TEW-940APBO2K Setup and Installation

When purchasing the point-to-point bridge kit, mode **TEW-940ABPO2K**, by default, the TEW-940APBO access points are preconfigured to establish a point-to-point wireless connection using **CSMA** channel access method in **WDS Access Point/Station**. For convenience, a unique predefined admin password has already been assigned to both access points. You can find the preconfigured access point settings on the wireless sticker or on the device label on the back of the unit. No additional configuration is required.

Unit 1

Preset  
Wireless Settings

Mode/WiFi Channel
AES Encryption Key XXXXXXXXXX

Management Login  
http://192.168.10.50

username: admin  
password: XXXXXXXX

Unit 2

Preset  
Wireless Settings

Mode/WiFi Channel
AES Encryption Key XXXXXXXXXX

Management Login  
http://192.168.10.51

username: admin  
password: XXXXXXXX

On the device label located inside, you can also find the preconfigured default settings of each access point.

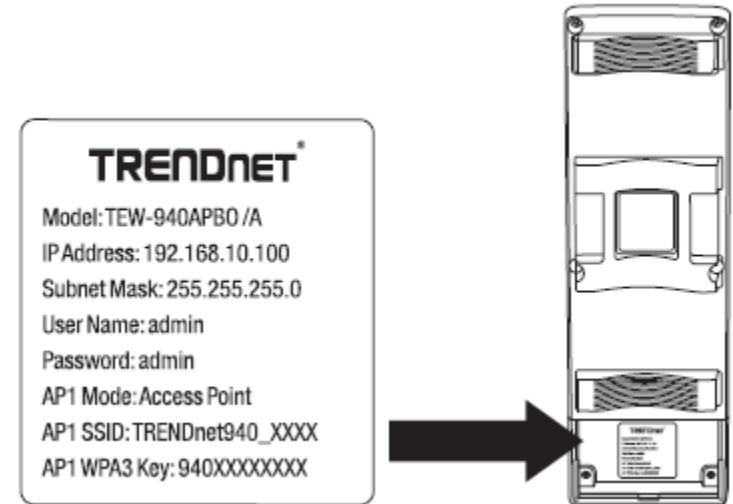

The TEW-940APBO access points will be preconfigured with the following settings:

	TEW-940APBO #1	TEW-940APBO #2
<b>IP Address</b>	192.168.10.50	192.168.10.51
<b>Netmask (Subnet Mask)</b>	255.255.255.0	255.255.255.0
<b>IP Gateway (Default Gateway)</b>	192.168.10.1	192.168.10.1
<b>Primary DNS</b>	192.168.10.1	192.168.10.1
<b>Wireless Channel (Default)</b>	48	48
<b>Channel Access Method</b>	TDMA	TDMA
<b>Mode</b>	WDS Access Point	WDS Station
<b>WDS Encryption</b>	WPA2	WPA2

## Setup and Confirm Connectivity

1. Remove the cover of the access points by pulling and holding the tab outwards (as shown in the picture below) and sliding the cover downwards, away from the access point.

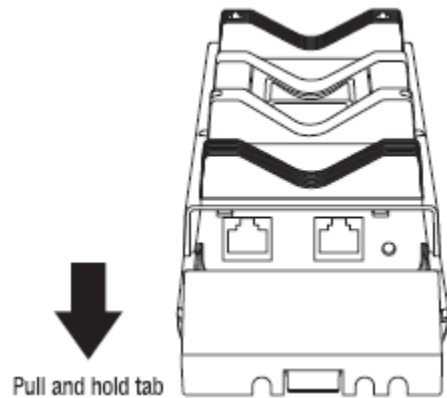

2. Using a RJ-45 network cable, connect one end of the cable to the **LAN1 (PoE)** port and ensure the cable is lined up with the Cable Guides before closing the cover. **(note: this RJ-45 network cable cannot exceed 60m)**

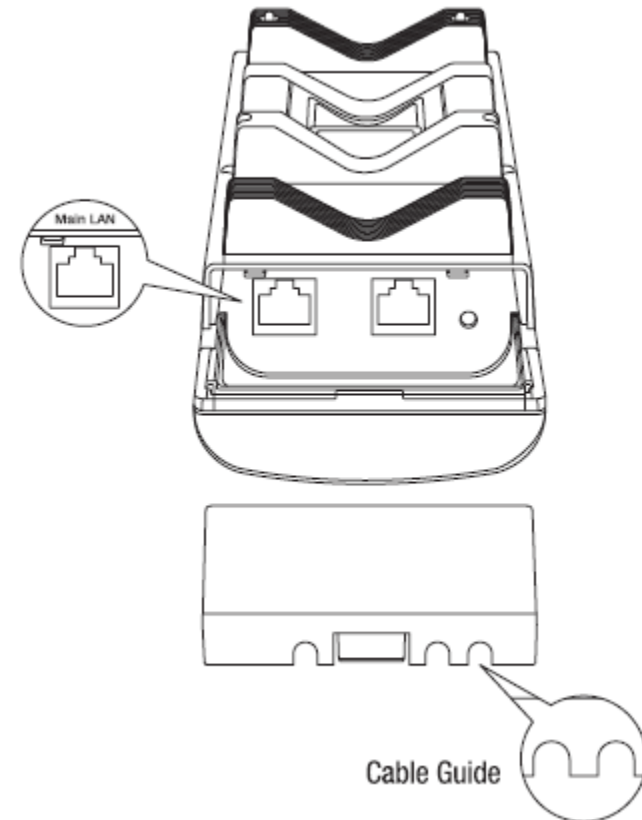

3. Connect the other end of the RJ-45 network cable to the **PoE** port on the included PoE injector. **(note: this RJ-45 network cable cannot exceed 60m)**
4. Using another RJ-45 network cable, connect one end to the **LAN** port on the included PoE injector.
5. Connect the other end of the RJ-45 network cable to your computer's Ethernet port.
6. Attach the power cord to the PoE injector and plug the connected power cord into a power outlet.

7. Confirm the device is powered on through the LED indicators.

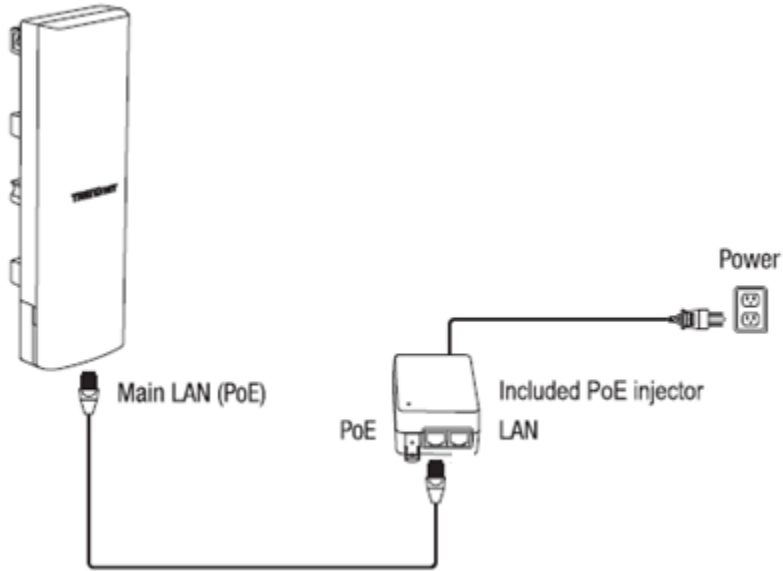

**Note:** Repeat steps 1-7 to power on and connect the second access point.

8. Assign a static IP address to your computer's network adapter in the subnet of 192.168.10.x (e.g. 192.168.10.10) and subnet mask of 255.255.255.0.

**Note:** For information on how to statically assign your IP address, see the Appendix section.

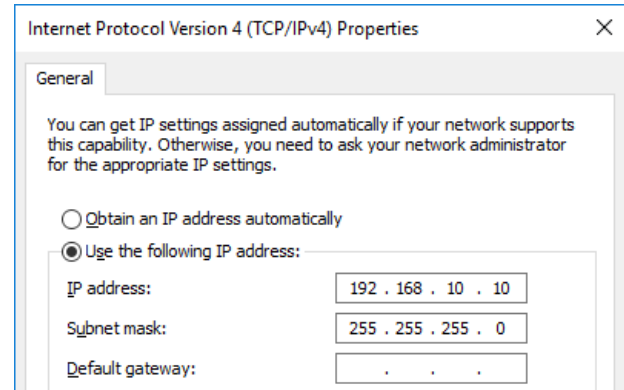

9. Using another network cable, connect one end to the LAN port on the included PoE injector for either the first or second access point.

10. Connect the other end of the network cable to your computer's Ethernet port.

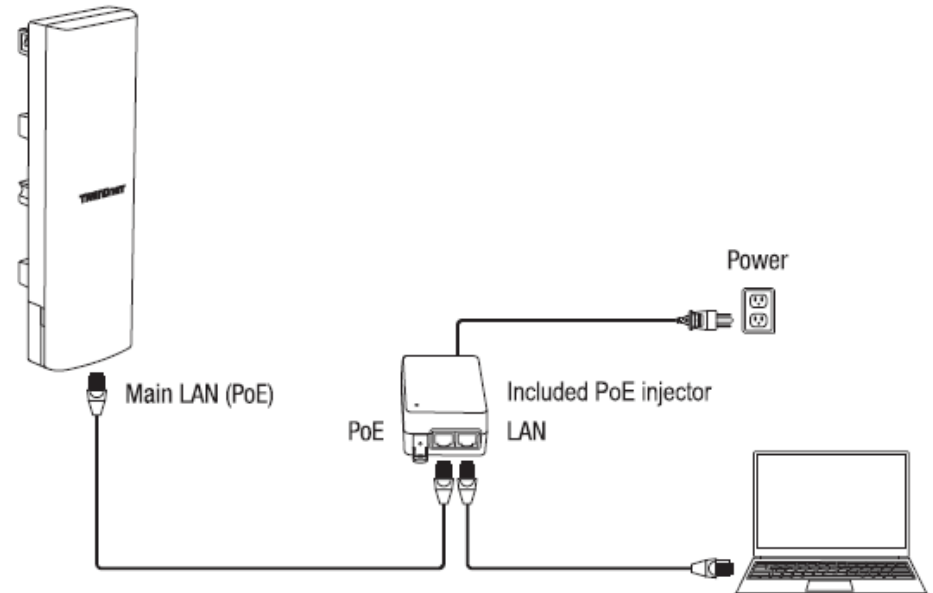

11. Make sure both access points are powered on approximately 15 ft. (5 m) apart from one another with front of access points directly facing each other.

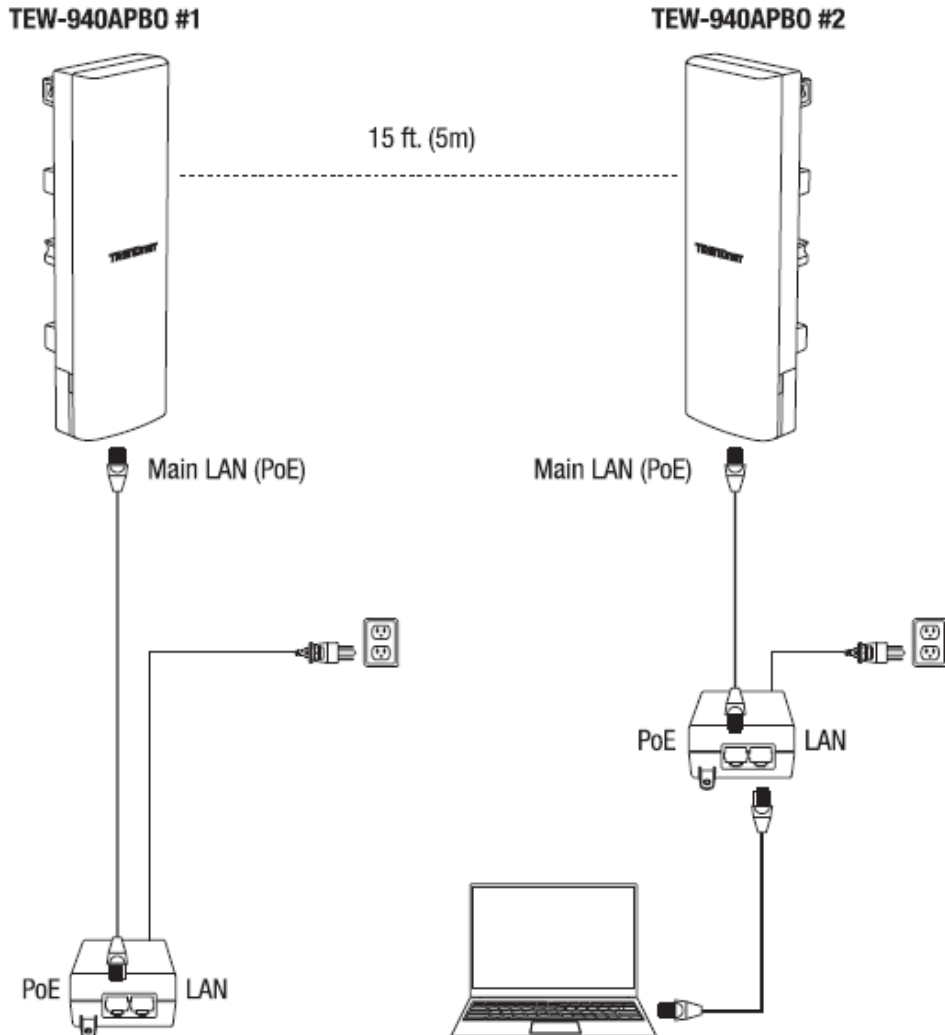

12. To verify connectivity on your computer, open a command prompt or terminal application window and type in the following commands.

- `ping 192.168.10.50`
- `<Press Enter and wait for result>`
- `ping 192.168.10.51`
- `<Press Enter and wait for result>`

**Note:** In Windows®, you can use the Command Prompt application and in Mac®, you can use the Terminal application to run the commands for connectivity testing.

A successful connectivity test will appear similar to the result below for each access point. Ping replies and 0% packet loss will indicate a successful point to point bridge connection between the two access points.

```
C:\WINDOWS\system32>ping 192.168.10.50

Pinging 192.168.10.50 with 32 bytes of data:
Reply from 192.168.10.50: bytes=32 time<1ms TTL=64
Reply from 192.168.10.50: bytes=32 time<1ms TTL=64
Reply from 192.168.10.50: bytes=32 time=1ms TTL=64
Reply from 192.168.10.50: bytes=32 time<1ms TTL=64

Ping statistics for 192.168.10.50:
    Packets: Sent = 4, Received = 4, Lost = 0 (0% loss),
    Approximate round trip times in milli-seconds:
        Minimum = 0ms, Maximum = 1ms, Average = 0ms

C:\WINDOWS\system32>ping 192.168.10.51

Pinging 192.168.10.51 with 32 bytes of data:
Reply from 192.168.10.51: bytes=32 time=2ms TTL=64
Reply from 192.168.10.51: bytes=32 time=3ms TTL=64
Reply from 192.168.10.51: bytes=32 time=2ms TTL=64
Reply from 192.168.10.51: bytes=32 time=5ms TTL=64

Ping statistics for 192.168.10.51:
    Packets: Sent = 4, Received = 4, Lost = 0 (0% loss),
    Approximate round trip times in milli-seconds:
        Minimum = 2ms, Maximum = 5ms, Average = 3ms
```

**Note:** If the connectivity test fails, wait for about 1 minute and try again. Make sure there are no obstacles between two access points and that they are not too close together.



## Pole Mount Installation

1. Reinstall the cover by lining up the guides into the notches as shown and push until the cover clips into place and is secured. The cover includes cable openings to route the connected Ethernet cable(s) when installing.

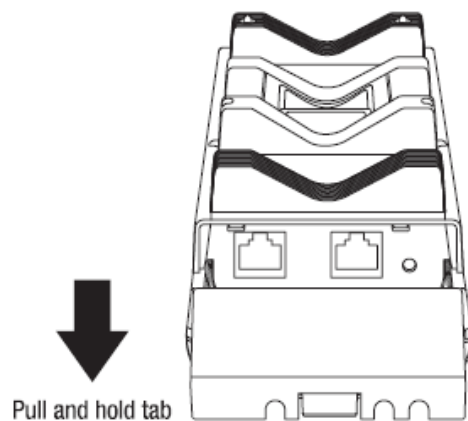

2. Loosen and open the pole mounting clamp using a flat head screwdriver or power drill turning the screw counter clockwise.

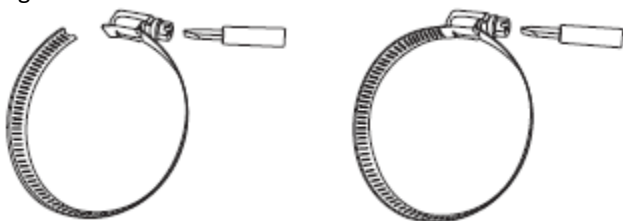

3. Insert the pole mounting clamp into the two openings at the back of the access point.

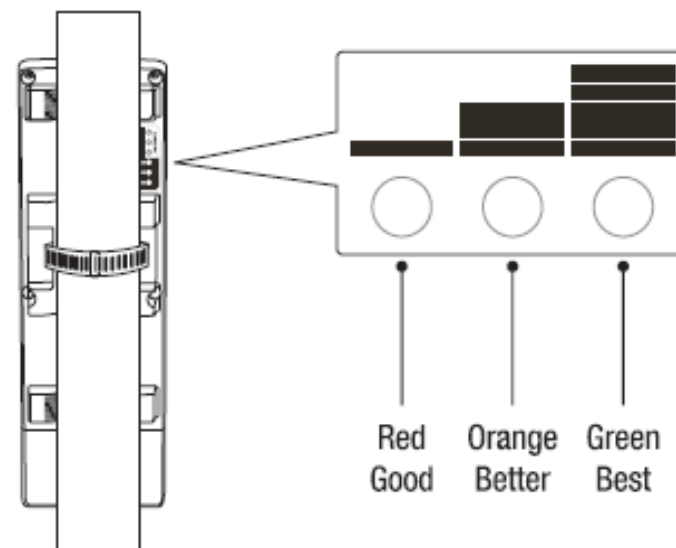

4. Secure the access point to the mounting location by turning the mounting clamp screw clockwise.

**Note:** When access point is set to Client Bridge mode operation, the TEW-940APBO features WiFi link/connection quality LEDs located on the back of the access point to assist in determining the optimal mounting position. (Red = Good, Orange = Better, Green = Best)

5. After the access points are properly mounted RJ-45 cables from each access point PoE injector to your network.

**Completed Installation Reference**

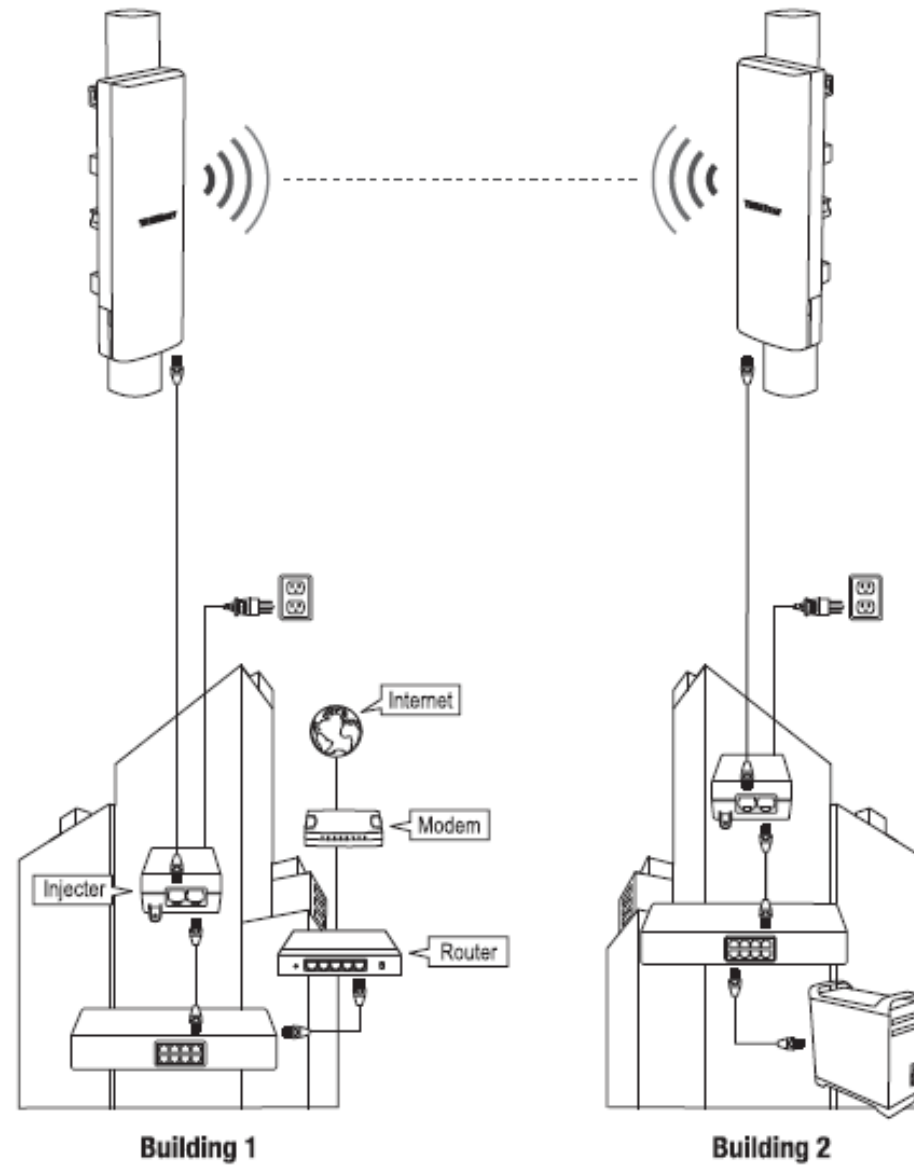

## Channel Access Method

In wireless networking, **Channel Access Method**, or **Multiple Access Method**, refers to the method used to enable simultaneous isolated communications between multiple devices all sharing the same “communication medium” of wireless radio airspace. TRENDnet's **TEW-940APBO** and **TEW-940APBO2K** supports **Carrier-Sense Multiple Access with Collision Avoidance (CSMA/CA)**, shortened to just **CSMA** and **Time-Division Multiple Access (TDMA)**.

### Carrier-Sense Multiple Access with Collision Avoidance (CSMA/CA)

**CSMA/CA** (Carrier Sense Multiple Access with Collision Avoidance) is the standard access mode used in 802.11 networks and is used for both access points and client device/station connectivity.

Due to allowing connections without any beacon packets and synchronization, CSMA/CA is better suited for environments with several networks in parallel.

Consequently, due to an increase in interference and energy consumption, CSMA/CA causes higher collision rates and decreases network throughput in a dense network when compared with TDMA. Retransmissions resulting from collisions are another factor in terms of network throughput and energy consumption.

- Industry standard.
- Simple, distributed, burden-less channel access method.
- Allows for fair sharing of network resources between contending nodes, at the cost of optimal quality of service and a guaranteed balance – especially when quantity of contending nodes increases.
- **Example:** IEEE 802.11 WiFi

## Application Modes

Although the access point is intended to be used for primarily WDS point-to-point bridging, the access point offers other operating modes. The access point multiple mode system which can be configured either in client bridge mode or as an access point. It also can be used as a WDS (Wireless Distribution System) link for Ethernet network expansion. This section explains the different modes the device has available, **Access Point (AP)**, **Client Bridge**, **WDS Access Point**, **WDS Station**, and **WDS Bridge (CSMA only)**.

The different operation modes can be found under **Network > Wireless > Operation Mode** in the access point web management page.

### Access Point (AP)

An **access point** can be either a main, relay or remote base station. A main base station is typically connected to a wired network via an Ethernet port. A relay base station relays data between main base stations and relay stations or remote base stations with clients. A remote base station is the end point to accept connections from wireless clients and pass data upstream to a network wirelessly.

#### Example: Access Point

- It can be deployed as a traditional fixed wireless access point.



### Client Bridge

**Client bridge** mode enables the device to essentially act as a wireless client while bridging the LAN ports on the device. In this mode, the AP functions similarly to that of a wireless client or station such as mobile phone, tablet, or notebook computer. The wired ports LAN1 (PoE) and LAN2 are logically bridged to the wireless interface. The wired clients of access point are in the same subnet from Main Base.

#### Example: AP with Client Bridge mode

- It can be deployed as a wireless client (with wired LAN) to a wireless access point.



## Repeater

**Repeater** mode lets the unit to repeat wireless signal and packets for backbone communication as well as client access. This feature is used to expand your existing wireless network to areas that your current access point is unable to reach. Make sure all of the settings of the wireless interface matches to your root or connecting wireless access points, same SSID, channel and wireless encryption settings.

### **Example:** AP with repeater mode

- It can be deployed as a traditional wireless repeater.

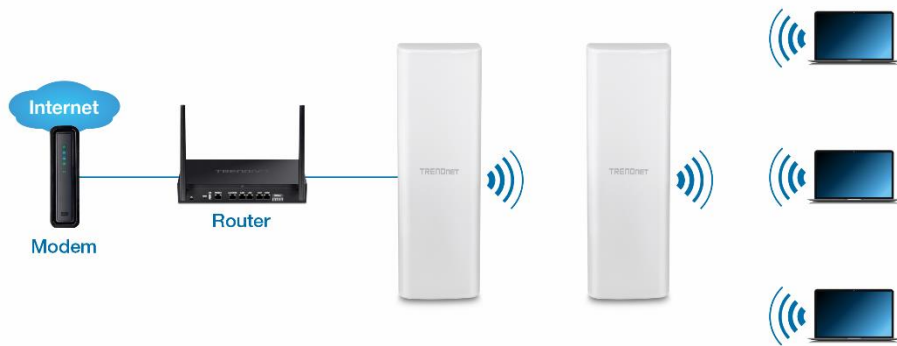

## Accessing your access point management page

### Access your access point management page

**Note:** TEW-940APBO Users: Your access point management page default IP address <http://192.168.10.100> is accessed through the use of your Internet web browser (e.g. Internet Explorer®, Firefox®, Chrome™, Safari®, and Opera™) and will be referenced frequently in this User's Guide.

TEW-940APBO2K Users: Your access point management page default IP addresses are <http://192.168.10.50> and <http://192.168.10.51>. Additionally, the pre-defined user name and password will be unique. This information will be printed on both the wireless settings stickers and device label located inside the access point enclosure.

### Unit 1

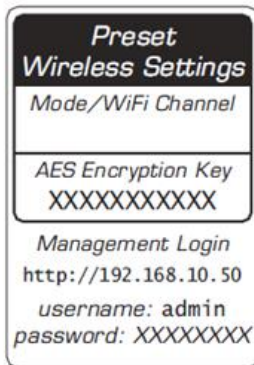

### Unit 2

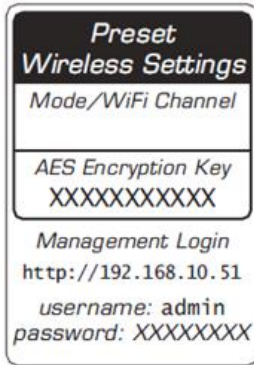

Model: TEW-840APBO /A  
IP Address: 192.168.10.100  
Subnet Mask: 255.255.255.0  
User Name: admin  
Password: admin  
Mode: WDS AP  
SSID: TRENDnet840\_XXXX  
WPA2 Key: 840XXXXXXXXX  
Default Channel: 48

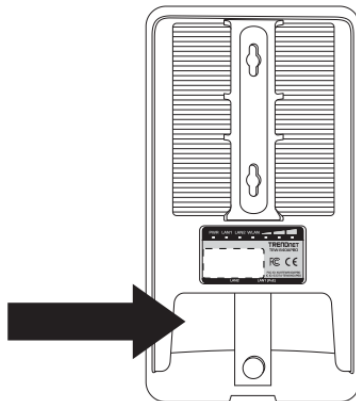

If you have changed the default IP address, you will need to ensure that your computer is configured with IP address settings in the same subnet as the as the access point in order to access the access point management page. Also, make sure your access point is powered on through the included PoE injector and your computer is connected to the gigabit DATA IN port on injector or connect to LAN2 Ethernet port. (Ex. Access Point IP address changed to 192.168.0.100 / 255.255.255.0, example computer address 192.168.0.25 / 255.255.255.0).

1. Open your web browser and go to the address <http://192.168.10.100> (TEW-940APBO) or <http://192.168.10.50> and <http://192.168.10.51> (TEW-940APBO2K). Your access point will prompt you for a user name and password.



2. TEW-940APBO Users: By default, the user name is *admin* and password is *admin*. TEW-940APBO2K Users: You can also find the wireless settings sticker included with the access points and on the device inside the access point enclosure. Enter your **Username** and **Password**, then click **Login**.

**Note:** If you have changed the password already such as in the Setup Wizard, you will need to login using the new password. User Name and Password are case sensitive.

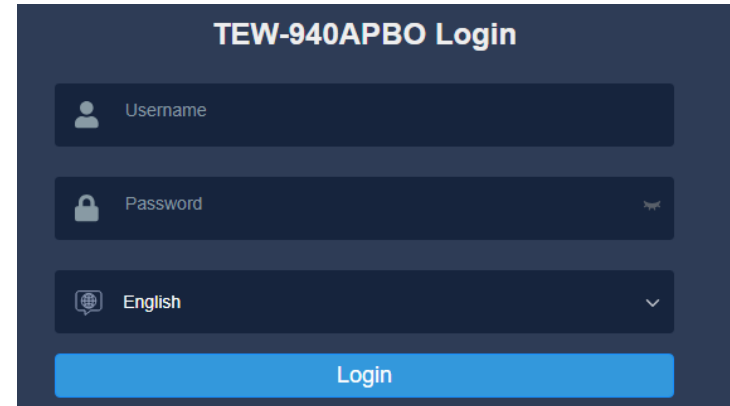

## Overview

### Device Status

Overview > Device Status

This page will display the AP system summary information such as the device name, serial number, system time, firmware version, MAC, IPv4/IPv6 address settings, WiFi information, etc.

1. Log into your access point management page (see "[Access your access point management page](#)" on page 29).
2. Click on **Device Status** from the left side menu. To refresh the page, click **Refresh** at the bottom of the page.

### Device Information

- **Device Name** – Displays the identifying device name of your access point. This information can be modified under the **Network > Wireless** section.
- **Firmware Version** – Displays the current firmware of the access point
- **System Time** – Displays the current time assigned to the access point. This information can be modified under the **System > Time and Date Settings** section.
- **System Up Time** – Displays the time the access point has been powered on.

#### System Information

Device Name	TEW-940APBO
Firmware Version	1.0.3.07
System Time	Thu Jun, 1, 2023 00:28:38
System Up Time	0 Day, 00:29:54

- **MAC Address**– Displays the MAC address for the access point's LAN radio.
- **IP Address** – Displays the IPv4 address assigned to the access point. This can be modified under the **Management > IP Settings** section.
- **Subnet Mask** – Displays the current IPv4 subnet mask assigned to your access point.

- **Gateway** – Displays the current gateway address assigned to your access point.
- **Primary DNS** – Displays the primary Domain Name Server (DNS) assigned to your access point.
- **Secondary DNS** – Displays the secondary Domain Name Server (DNS) assigned to your access point.

Network	
MAC Address	78:2D:7E:25:07:D2
IP Address	192.168.10.51
Subnet Mask	255.255.255.0
Default Gateway	192.168.10.1
Primary Domain Name Server	0.0.0.0
Secondary Domain Name Server	0.0.0.0

### 5GHz Wireless

- **Operation Mode** – Displays the current mode the access point is on
- **Wireless Mode** – Displays the current wireless standard the access point is using
- **Channel Width** – Displays the channel width the wireless is operating on
- **Frequency (Channel)** – Displays the current channel the 5GHz wireless is using
- **Tx (Packets)** – Displays the amount of data has been downloaded
- **Rx (Packets)** – Displays the amount of data has been uploaded

5GHz Wireless	
Operation Mode	Client Bridge
Wireless Mode	802.11 ax
Channel Width	HT80
Frequency (Channel)	CH36 - 5.18GHz
TX (Packets)	0.00B (0 PKts.)
RX (Packets)	0.00B (0 PKts.)

### Memory Information

- This section displays the access point's memory or RAM and CPU usage status.



CPU & Memory Utilization

CPU	Used	10%
	Idle	90%
Memory	Total	355852 KB
	Free	197680 KB
	Used	158172 KB

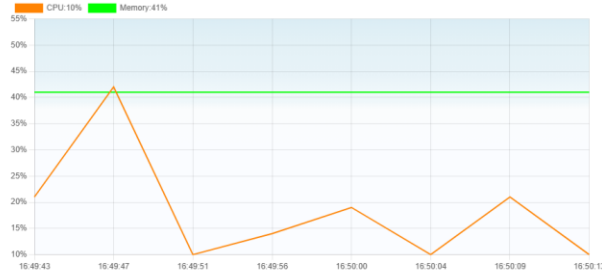

Total Throughput

This section displays the access point's total throughput, and total data usage over time.

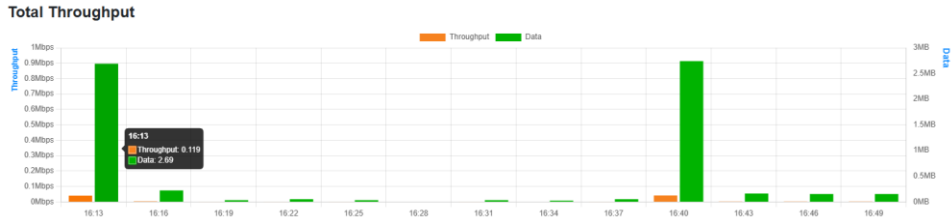

Connections

Dashboard > Connection Status

This page will display all active connections that have been established with the access point.

1. Log into your access point management page (see "[Access your access point management page](#)" on page 29).
2. Click on **Dashboard** and then click on **Connection Status** from the left side menu.
  - **Operation Mode** – Displays the operation mode
  - **SSID** – Displays wireless SSID of the 5G connection
  - **BSSID** – Displays the MAC address of the connected AP
  - **Associated BSSID** – Displays the MAC address of the device
  - **Channel** – Displays the WiFi channel is connected on 5G connection
  - **Wireless Mode** – Displays the wireless connection standard for the wireless connection
  - **Security** – Displays the WiFi encryption
  - **Data Rate** – Displays the current data rate between the WiFi connections
  - **Signal Level** – Displays the strength of the signal
  - **Noise Level** – Displays the noise level of the WiFi signal.

## 5GHz / Connection Status

Operation Mode	Client Bridge
SSID	TRENDnet940_07D0
BSSID	78:2D:7E:25:07:D3
Associated BSSID	78:2D:7E:25:07:D1
Channel	CH153
Wireless Mode	802.11AX
Security	WPA3-Personal Mixed
Data Rate	1.201Gb/s
Signal Level	-34dBm
Noise Level	-95dBm

## System Log

Dashboard > System Log

This section displays the device logging information for monitoring and troubleshooting purposes.

1. Log into your access point management page (see "[Access your access point management page](#)" on page 29).
2. Click on **Dashboard** and then click on **System Log** from the left side menu.
3. Click on **Refresh** to refresh your logs and click on **Clear** to clear the system log.

## System log

```
Thu Jun 1 22:28:52 2023 daemon.info HTTP: [admin] login
Thu Jun 1 00:28:20 2023 daemon.info HTTP: [admin] login
Thu Jun 1 00:03:07 2023 daemon.info HTTP: [admin] login
Thu Jun 1 00:00:39 2023 daemon.info SSH: stopping service.
Thu Jun 1 00:00:39 2023 daemon.info SSH: stopping service.
Thu Jun 1 00:00:01 2023 daemon.info SNMP: starting service.
Thu Jun 1 00:00:01 2023 daemon.info UPnP: stopping service.
```

Refresh

Clear

## IPv6 Status

Dashboard > IPv6 Status

This section displays the device logging information for monitoring and troubleshooting purposes.

1. Log into your access point management page (see "[Access your access point management page](#)" on page 29).
2. Click on **Dashboard** and then click on **IPv6 Status** from the left side menu.
3. Review the settings below.
  - **IPv6 Connection Type** – Displays the IPv6 Connection Type
  - **IPv6 IP Address** – Displays the IPv6 IP address.
  - **LAN IPv6 Link-Local Address** – Displays the LAN IPv6 Address
  - **IPv6 Default Gateway** – Displays the IP address of the gateway
  - **Primary IPv6 DNS Server** – Displays the IPv6 address of the primary DNS server
  - **Secondary IPv6 DNS Server** – Displays the IPv6 address of the secondary DNS server

Network	
IPv6 Connection Type	Autoconfiguration (SLAAC/DHCPv6)
IPv6 IP Address	-
LAN IPv6 Link-Local Address	fe80::7a2d:7eff:fe25:7d2/64
IPv6 Default Gateway	-
Primary IPv6 DNS Server	-
Secondary IPv6 DNS Server	-

## Operation Mode

System > Operation Mode

This page allows the change in the operation mode for your access point.

1. Log into your access point management page (see "[Access your access point management page](#)" on page 29).
2. Click on **System** and then click on **Operation Mode** from the left side menu.
3. Select the operation mode for the access point.

Device Name : TEW-940APBO

5GHz Operation Mode

Client Bridge

4. Click **Apply** to apply the settings and **Save** to save the changes to the flash.

Apply



## IP Settings

System > IP Settings

This page will allow you to set your IP settings.

1. Log into your access point management page (see "[Access your access point management page](#)" on page 29).
2. Click on **System** and then click on **IP Settings** from the left side menu.
3. Select the type of connection type from the drop down menu in **Connection Type**.
  - **Static** – Selecting this mode will allow you to manually configure your IP settings
  - **DHCP** – Selecting this method will allow your access point to automatically set your IP settings based off of the gateway.

### LAN Connection Type

Connection Type

STATIC

4. Review your LAN settings below
  - **IP Address** – Input your IP address for the
  - **Subnet Mast** – Input the subnet mask for the LAN settings
  - **Default Gateway** – Set the default IP address of the gateway

### LAN Interface Setting

IP Address

192.168.10.51

Subnet Mask

255.255.255.0

Default Gateway

192.168.10.1

5. Input your **Primary** and **Secondary DNS Server**

DNS Server Setting	
Primary DNS Server	<input type="text"/>
Secondary DNS Server	<input type="text"/>

6. Click **Apply** to apply the settings and **Save** to save the changes to the flash.

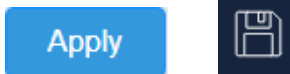

### IPv6 Settings

System > IPv6 Settings

This page allows you to configure your IPv6 settings.

1. Log into your access point management page (see "[Access your access point management page](#)" on page 29).
2. Click on **System** and then click on **IPv6 Settings** from the left side menu.
3. Select the IPv6 connection type.

#### Autoconfiguration (SLAAC/DHCPv6)

Select this method easily configuration of IPv6

- Select **Obtain IPv6 DNS server address automatically** for the access point to automatically obtain the DNS server address
- Select **Use the following IPv6 DNS servers** for the access point to manually input the DNS server address

IPv6 DNS SETTINGS	
DNS server access method	Obtain IPv6 DNS server address autor ▾
Primary DNS Server	Use the following IPv6 DNS servers Obtain IPv6 DNS server address automatically
Secondary DNS Server	<input type="text"/>

#### Static IPv6

Select this method to manually input the IPv6 address settings

- **LAN IPv6 Address** – Input the IPv6 address for the LAN network
- **Subnet Prefix Length** – Input the subnet prefix length
- **Default Gateway** – Input the IPv6 address for the default gateway
- **Primary DNS Server / Secondary DNS Server** – Input the IPv6 address for the DNS servers

LAN IPv6 ADDRESS SETTINGS	
LAN IPv6 Address	<input type="text"/>
Subnet Prefix Length	<input type="text"/>
Default Gateway	<input type="text"/>
Primary DNS Server	<input type="text"/>
Secondary DNS Server	<input type="text"/>

#### Local Connectivity Only

Select this method for IPv6 addresses to be used locally on your LAN only.

4. Click **Apply** to apply the settings and **Save** to save the changes to the flash.

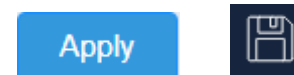

### Spanning Tree Settings

System > Spanning Tree Settings

1. Log into your access point management page (see "[Access your access point management page](#)" on page 29).

- Click on **System** and then click on **Spanning Tree** from the left side menu.
- Review the settings below
  - Status** – Select either to **Enable** or **Disable** STP. *Default: Disabled*
  - Bridge Hello Time** – Enter the desired hello time (in seconds)
  - Bridge Max Age** – Enter the desired max age (in seconds).
  - Bridge Forward Delay** – Enter the desired forward delay (in seconds).
  - Priority** – Enter the desired priority of this STP configuration.

## Management VLAN

System > Management VLAN

- Log into your access point management page (see “[Access your access point management page](#)” on page 29).
- Click on **System** and then click on **Management VLAN** from the left side menu.
- Select **No VLAN tag** to not enable VLAN and **Specified VLAN ID** to enable VLAN tag. Input the VLAN ID.

Management VLAN Settings	
Management VLAN ID	Specified VLAN <input type="text" value="1"/> (must be in the range 1 ~ 4092.)

- Click **Apply** to apply the settings and **Save** to save the changes to the flash.



## Time and Date Settings

System > Time and Date Settings

This page lets you set your time and date settings for your access point.

- Log into your access point management page (see “[Access your access point management page](#)” on page 29).
- Click on **System** and then click on **Time and Date Settings** from the left side menu.
- Select the time zone for your access point

Time Configuration	
System Time	Fri Jun, 2, 2023 00:40:52
Time Zone	GMT-08:00 Pacific Time (US Canada), ▾

### Set the Daylight Savings Settings

- Select **Enabled** in **Enable Daylight Saving** to enable daylight savings time, or **Disable** to disable it.
- Select the offset for **Daylight Savings Offset**
- Select the time when the daylight savings will start and when it will end

Daylight Savings Time	
Enable Daylight Saving	Enabled ▾
Daylight Saving Offset	+1:00 ▾
DST Start	Month <input type="text" value="Mar"/> Week <input type="text" value="2nd"/> Day of Week <input type="text" value="Sun"/> Hour <input type="text" value="02"/>
DST End	Month <input type="text" value="Nov"/> Week <input type="text" value="1st"/> Day of Week <input type="text" value="Sun"/> Hour <input type="text" value="02"/>

### Date/Time Settings

- Select either **Local Time** for manual input or **SNTP** for the date and time to be pulled from a server in **Clock Mode**.
- Input the date and time settings if **Local Time** is selected.

Date/Time Settings	
Clock Mode	Local Time ▾
Date Settings	Year <input type="text" value="2023"/> Month <input type="text" value="Jun"/> Day <input type="text" value="01"/>
Time Settings	Hour <input type="text" value="00"/> Minutes <input type="text" value="00"/> Second <input type="text" value="00"/>

- Input the **NTP server address** and how often the access point will sync (**NTP Synchronization**) with the NTP server if SNTP is selected for Clock Mode.

Date/Time Settings	
Clock Mode	SNTP
NTP Server	time.nist.gov
NTP synchronization	300 (1~300) Minutes

## WiFi Scheduling

System > Schedule

This section allows the definition of schedules for when the wireless band should be enabled, disabled or to schedule a reboot.

- Log into your access point management page (see "[Access your access point management page](#)" on page 29).
- Click on **System** and then click on **Schedule** from the left side menu.
- Select **Enabled** to enable scheduling or **Disable** to disable the scheduling function.

### Schedule Rule Status

Wireless Schedule Enabled

### Setting a Schedule

- Review the settings below
  - Rule Name** – Input the name of the rule
  - Service** – Type of action to be taken with the rule
  - Days** – Select the days for this rule to apply to
  - Start Time / End Time** – Select the time for the beginning of the rule and the end.

Add Schedule Rule	
Rule Name	<input type="text"/>
Service	Reboot
Day(s)	Select Day(s) <input type="checkbox"/> Sun <input type="checkbox"/> Mon <input type="checkbox"/> Tue <input type="checkbox"/> Wed <input type="checkbox"/> Thur <input type="checkbox"/> Fri <input type="checkbox"/> Sat
Start Time	00 : 00
End Time	00 : 00

- Click **Apply** to apply the settings and **Save** to save the changes to the flash.



## LED Controls

System > LED Control

- Log into your access point management page (see "[Access your access point management page](#)" on page 29).
- Click on **System** and then click on **LED Control** from the left side menu.
- Toggle the switch **On** or **Off** to enable or disable the LEDs on the unit.

### LED Control

LED OFF  ON

## LLDP

System > LLDP

Link Layer Discovery Protocol allows this device to advertise itself on the network.

1. Log into your access point management page (see "[Access your access point management page](#)" on page 29).
2. Click on **System** and then click on **LLDP** from the left side menu.
3. Select **Enabled** to enable LLDP and **Disabled** to disable this feature.

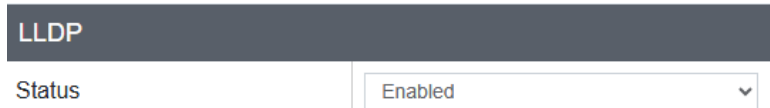

4. Click **Apply** to apply the settings and **Save** to save the changes to the flash.

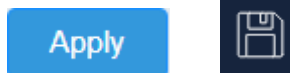

## UPnP

*System > UPnP*

This section allows the discovery of your access point on the same network via UPnP.

1. Log into your access point management page (see "[Access your access point management page](#)" on page 29).
2. Click on **System** and then click on **LLDP** from the left side menu.
3. Select **Enabled** to enable UPnP and **Disabled** to disable UPnP



4. Click **Apply** to apply the settings and **Save** to save the changes to the flash.



## Bonjour

*System > Bonjour*

Bonjour is a zero-configuration networking protocol that enables automatic discovery of devices and services on a local network.

1. Log into your access point management page (see "[Access your access point management page](#)" on page 29).
2. Click on **System** and then click on **Bonjour** from the left side menu.
3. Select **Enabled** to enable Bonjour and **Disabled** to disable this feature.

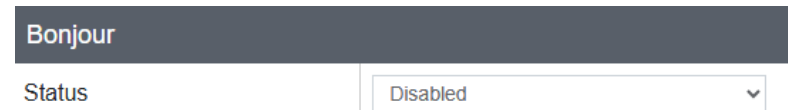

4. Click **Apply** to apply the settings and **Save** to save the changes to the flash.



## Ping Watch Dog

*System > Gateway Monitor*

Ping Watch Dog allows your access point to automatically reboot if a ping cannot be reached.

1. Log into your access point management page (see "[Access your access point management page](#)" on page 29).
2. Click on **System** and then click on **Gateway Monitor** from the left side menu.
3. Select **Enabled** to enable Ping Watch Dog and **Disabled** to disable this feature.



4. Review the settings below
  - **Gateway IP Address** – Input the IP address of the gateway to ping
  - **Delay Between Timeouts** – Input the time between each ping in seconds
  - **Timeout Attempts Before Reboot** – Input the number of failed ping attempts before a reboot of your access point
  - **Ping Delay After Auto Reboot** – Input the time between the next ping check after an auto reboot
  - **Reboot Attempts** – Input how many times your access point will reboot

## Wireless Network

Wireless 5GHz > Wireless Network

This page allows the setup of the WiFi network for the access point.

1. Log into your access point management page (see "[Access your access point management page](#)" on page 29).
2. Click on **Wireless 5GHz** and then click on **Wireless Network** from the left side menu.

### AP Mode

Review the settings below for AP Mode

- **Wireless Mode** – select the wireless mode for your access point
- **Channel Width** – Select the channel width for the access point
- **Frequency** – Set the frequency for the wireless network
- **AP Detection** – Scan the local network for other wireless APs

Wireless Network	
Wireless Mode	802.11 ax
Channel Width	80 MHz
Frequency (Channel)	Auto
AP Detection	<input type="button" value="Scan"/>

- **Status** – Select **Enabled** to enable the selected SSID, or **Disable** to disable the SSID
- **SSID** – Display and edits the current SSID
- **Security Mode** – Select the type of encryption for the SSID
- **Password** – Displays and edit the current password
- **Edit** – Click **Edit** to set the advance settings of the SSID

Current Profiles				
Status	SSID	Security Mode	Password	Edit / Add
Enabled	TRENDnet940_07D2	WPA3-SAE Mixed AES	*****	<input type="button" value="Edit"/>
Disabled		None		<input type="button" value="Edit"/>

- **SSID** – Display and edit the current SSID
- **Status** – Select **Enabled** to enable the selected SSID, or **Disable** to disable the SSID
- **Hhide SSID** – Selected **Enabled** to hide the SSID or **Disabled** to disable it
- **Separate Stations** – Select **Enabled** to separate clients from the local network and **Disabled** to disable this
- **Security Mode** – Select the type of encryption for the selected SSID

Wireless Settings	
SSID	TRENDnet940_07D2
Status	Enabled
Hide SSID	Disabled
Separate Stations	Disabled

Wireless Security	
Security Mode	WPA3-Personal Mixed

- **WPA Cipher** – Select the type of the WPA cipher for the selected encryption mode
- **Pre-Shared Key** – Input the password for the selected encryption
- **Key Update Interval** – Input the time for the Key Update Interval

- **802.11k Support** – Select **Enabled** to enable 802.11k roaming
- **Scan Period** – Select the time for the scan period

WPA	
WPA Cipher	AES
Pre-Shared Key	*****
Key Update Interval	3600 Seconds
Roaming Assistant	
802.11k Support	Disabled
Scan Period	10 Minutes

- **Rule Name** – Input a name for the rule to turn on and off the wireless schedule
- **Days** – Select the days for this rule to apply to
- **Start / End Time** – Select the start and end time for this rule

**Client Bridge Mode**

Review the settings below for client bridge mode

- **Wireless Mode** – Displays the current wireless mode for the access point
- **SSID** – Input the SSID of the wireless network to connect this access point to
- **Site Survey** – Click on this for the access point to scan the area of other access points to connect to. Click on the SSID to connect the access point to.
- **Preferred BSSID** – Select **Enabled** to enable BSSID and **Disabled** to disable it.

Wireless Network	
Wireless Mode	802.11 ax
SSID	TRENDnet940_07D0 <a href="#">Site Survey</a>
Preferred BSSID	Enabled 78:2D:7E:25:07:D1

- **Security Mode** – Select the encryption for the access point
- **WPA Cipher** – Select the type of the WPA cipher for the selected encryption mode
- **Pre-Shared Key** – Input the password for the selected encryption

**Repeater Mode**

Review the settings below for the access point in repeater mode

- **Wireless Mode** – Displays the current wireless mode for the access point
- **SSID** – Input the SSID of the wireless network to connect this access point to
- **Site Survey** – Click on this for the access point to scan the area of other access points to connect to. Click on the SSID to connect the access point to.
- **Preferred BSSID** – Select **Enabled** to enable BSSID and **Disabled** to disable it.
- **Repeater SSID** – Input the SSID

Wireless Network	
Wireless Mode	802.11 ax
SSID	TRENDnet940_07D0 <a href="#">Site Survey</a>
Preferred BSSID	Enabled 78:2D:7E:25:07:D1
Repeater SSID	Repeater SSID

- **Security Mode** – Select the type of encryption for the selected SSID
- **WPA Cipher** – Select the type of the WPA cipher for the selected encryption mode
- **Pre-Shared Key** – Input the password for the selected encryption

Wireless Security	
Security Mode	WPA3-Personal Mixed
WPA	
WPA Cipher	AES
Pre-Shared Key	*****

**Bandwidth Control**

*Wireless 5GHz > Wireless Bandwidth Control*

This section allows the maximum download and upload throughput through the selected wireless band and wireless SSID. Bandwidth control is only available when the access point is in **AP Mode**.

1. Log into your access point management page (see "[Access your access point management page](#)" on page 27).
2. Click on **Wireless 5GHz** and then click on **Wireless Network** from the left side menu.
3. Select **Enabled** to enable bandwidth control for the selected wireless band or **Disabled** to disable it.
4. Review the settings below:
  - **Status** – Select **Enabled** to enable bandwidth control for the selected SSID or **Disabled** to disable it
  - **SSID** – Displays the SSID
  - **Download MAX** – Input the max download throughput in (bits per second)
  - **Upload Limit** – Input the max upload throughput in (bits per second)

Wireless Bandwidth Control			
Bandwidth Control	Disabled		
Current Profiles			
Status	SSID	Download MAX	Upload Limit
Disabled	TRENDnet940_07D2	10m bps	1m bps

5. Click **Apply** to apply the settings and click **Save** the changes permanently to the flash by clicking the **Save** button in the top right corner.



## Wireless RSSI Scanner

*Wireless 5GHz > Wireless RSSI Scanner*

This section allows you to setup each VAP RSSI value. When STAs RSSI is less than the setting value, AP will disassociate with STA. Wireless RSSI Scanner is only available in AP mode.

1. Log into your access point management page (see "[Access your access point management page](#)" on page 27).
2. Click on **Wireless 5GHz** and then click on **Wireless RSSI Scanner** from the left side menu.
3. Review the settings below and click **Apply** to apply the settings
  - **Status** – Select **Enabled** to enable RSSI scanner for the selected SSID or **Disabled** to disable it.
  - **SSID** – Displays the SSID
  - **Tolerance** – Set the action for the clients connected to the selected SSID
    - **Kick immediately** – Kick clients when it passes the RSSI threshold
    - **Detect 15, 30, 45 seconds** – Check if the client has still surpassed the RSSI threshold after the selected time frame
  - **RSSI value** – Set the RSSI threshold value

Current Profiles			
Status	SSID	Tolerance	RSSI value
Disabled	TRENDnet940_07D2	kick immediately	-90 dBm
Disabled		kick immediately	-90 dBm

4. Click **Apply** to apply the settings and click **Save** the changes permanently to the flash by clicking the **Save** button in the top right corner.

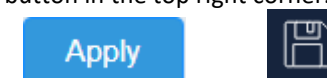

## Wireless MAC Filter

Wireless 5GHz > Wireless MAC Filter

This section allows you to setup additional security filters by specifying which device wireless MAC addresses are allowed or denied access on your access point wireless network. Wireless MAC Filter in AP Mode and Repeater Mode

### AP Mode & Repeater Mode

1. Log into your access point management page (see "[Access your access point management page](#)" on page 27).
2. Click on **Wireless 5GHz** and then click on **Wireless MAC Filter**
3. Select **Allow listed computers access and deny all others** to enable clients of specified MAC addresses wireless network access. To block clients of wireless network access, select **DENY listed computers access and allow all others**. Select **Disabled** to disable this feature.
4. Input the MAC Address of the client in the **MAC Address** field.

### Wireless MAC Filter

Filter Mode	ALLOW listed computers access and deny a
MAC Address	<input type="text"/> (Ex: 00:11:22:33:44:55)

5. Click **Apply** to apply the settings and click **Save** the changes permanently to the flash by clicking the **Save** button in the top right corner.



## Wireless Advanced Settings

Wireless 5GHz > Wireless Advanced Settings

1. Log into your access point management page (see "[Access your access point management page](#)" on page 27).
2. Click on **Wireless Advanced Settings** under **Wireless 2.4GHz / Wireless GHz** from the left side menu. Please note, when clicking **Save**, the settings are saved but not applied yet.
3. Review the settings below and click **Apply** to apply the settings.
  - **Transmit Power** – Select the transmit power of the selected wireless band
  - **RTS/CTS Threshold** – Input the RTS or CTS threshold. By default it is set to 2346.
  - **Beacon Period** – Set the beacon period. By default it is set to 100
  - **DTIM** – Input the desired DTIM. By default, it is set to 1.
  - **ARP Proxy** – Select **Enabled** to enable ARP Proxy or **Disabled** to disable it (**AP Mode & Repeater Mode only**)
  - **Wi-Fi Multimedia (WMM)** – Select **Enabled** to enable WMM or **Disabled** to disable it. By default it is set to Disabled. (**AP Mode**)

### Advanced Wireless

Transmit Power	6 dBm	
RTS/CTS Threshold	2346	(range 1 - 2346, default 2346)
Beacon Period	100	ms (range 100 - 1000, default 100)
DTIM	1	(range 1 - 255, default 1)
ARP Proxy	Disabled	
Wi-Fi Multimedia (WMM)	Enabled	

### HT Physical Mode

- **Guard Interval** – Select the Guard Interval. By default the Guard Interval is set to Auto.
- **A-MPDU** – Select **Enabled** to enable A-MPDU or **Disabled** to disable it.
  - Input the amount of Frames and select the maximum KB to support.

HT Physical Mode	
Guard Interval	Auto
A-MPDU	Enabled
255	Frames 1024
	KBytes (Max)

#### Client Limit (AP Mode & Repeater Mode only)

- **Client Limit** – Select **Enabled** to enable the maximum number of clients that can be connected to the wireless band or **Disabled** to disable this feature
- **Max Client** – Input the maximum number of devices that can be connected to the wireless band concurrently.

Client Limit	
Client Limit	Disabled
Max Client	127

4. Click **Apply** to apply the settings and click **Save** the changes permanently to the flash by clicking the **Save** button in the top right corner.



## WPS

Wireless 5GHz > WPS

This section allows you to activate WPS (Wi-Fi Protected Setup) which allows you to easily connect WPS capable wireless client devices to your access point.

1. Log into your access point management page (see "[Access your access point management page](#)" on page 27).
2. Click on **Wireless 5GHz** and then click on **WPS**.

3. Select **Enabled** to enable WPS on this access point and **Disabled** to disable this feature.

WPS Config	
WPS	Disabled

4. Click **Apply** to apply the settings and click **Save** the changes permanently to the flash by clicking the **Save** button in the top right corner.



## Management

### System Management

Management > System Management

1. Log into your access point management page (see "[Access your access point management page](#)" on page 27).
2. Click on **System Management** under **Management** from the left side menu. Please note, when clicking **Save**, the settings are saved but not applied yet.
3. Input the name of the device in **Device Name**.

System Settings	
Device Name	TEW-941APBO

4. Click **Apply** to apply the settings and click **Save** the changes permanently to the flash by clicking the **Save** button in the top right corner.



## Administration

Management >System Management

1. Log into your access point management page (see "[Access your access point management page](#)" on page 27).
2. Click on **Administration** under **Management** from the left side menu. Please note, when clicking **Save**, the settings are saved but not applied yet.
3. Input the User Name, Password and the Confirm Password. Click on **Add** to add the new Username and Password.

Administrator Settings	
User Name	<input type="text"/> (Maximum length is 20)
Password	<input type="password"/> (Maximum length is 20)
Confirm Password	<input type="password"/>

4. From the administrator setting, the password for the user account could be modified or the account could be deleted by clicking on **Modify** or **Delete**. The default admin user account cannot be deleted.

Administration Table			
Index	User Name	Password	Action
1	admin	*****	<input type="button" value="Modify"/>
2	trendnet	*****	<input type="button" value="Modify"/> <input type="button" value="Delete"/>

## Timeout Settings

Management >Timeout

1. Log into your access point management page (see "[Access your access point management page](#)" on page 27).

2. Click on **Timeout** under **Management** from the left side menu. Please note, when clicking **Save**, the settings are saved but not applied yet.
3. Input the time for the for the Idle timeout settings.

Timeout Settings	
Web Idle Timeout	<input type="text" value="3600"/> (120-3600 Seconds)

4. Click **Apply** to apply the settings and click **Save** the changes permanently to the flash by clicking the **Save** button in the top right corner.



## SNMP Settings

Management >SNMP Settings

1. Log into your access point management page (see "[Access your access point management page](#)" on page 27).
2. Click on **SNMP Settings** under **Management** from the left side menu. Please note, when clicking **Save**, the settings are saved but not applied yet.
3. Review the SNMP settings below

### SNMP Settings

- **SNMP** – Select **Enable** to enable SNMP. *Default: Disabled*
- **Contact** – Enter the **Contact** for the SNMP in this field.
- **Location** – Enter the **Location** for the SNMP in this field.
- **Community Name (Read Only)** – Enter the community name designated with **Read Only** permissions.
- **Community Name (Read Write)** – Enter the community name designated with **Read Write** permissions.
- **Trap Destination Address** - Enter the IP address for the SNMP trap destination

- **Trap Destination Community Name** – Enter the community name for the SNMP trap destination (defined above).
- **SNMPv3** – Select **Enable** to enable SNMP v3
- **Username** – Enter the username for the SNMPv3.
- **Authorized Protocol** – Select the authorized protocol for the SNMPv3.
- **Authorized Key** – Enter the key for the protocol specified above for SNMPv3.
- **Private Protocol** – Select the private protocol for the SNMPv3.
- **Private Key** – Enter the private key for the protocol specified above for SNMPv3.
- **Engine ID** – Enter the engine ID.

SNMP Settings	
SNMP	Enabled
Contact	
Location	
Community Name (Read Only)	public
Community Name (Read/Write)	private
Trap Destination Address	
Trap Destination Community Name	public
SNMPv3	Disabled
User Name	admin
Auth Protocol	None
Auth Key (8-32 Characters)	*****
Priv Protocol	None
Priv Key (8-32 Characters)	*****
Engine ID	

4. Click **Apply** to apply the settings and click **Save** the changes permanently to the flash by clicking the **Save** button in the top right corner.

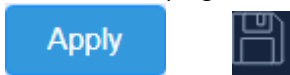

### Settings Management

Management >Backup/Restore Settings

1. Log into your access point management page (see "[Access your access point management page](#)" on page 27).
2. Click on **Backup/Restore Settings** under **Management** from the left side menu. Please note, when clicking **Save**, the settings are saved but not applied yet.

#### Export Config Files

1. To download the config file, click **Export** to export your device's current configuration to your computer.



2. The file will be saved to your selected download folder.

#### Import Config Files

1. Click on **Choose File** to Import your config file.



2. Select the file will have a .des3 file extension. Click **Open** or **Upload** to use the selected file.

#### Reset to Factory Default / System Reboot

- To reset the unit back to factory, click **Load Default**.
- To reboot the unit, click on **Reboot**.

## Reset to Factory Defaults

Load Default

Load Default

## System Reboot

System Reboot

Reboot







**Settings Management***Management > Upload Firmware*

1. Log into your access point management page (see "[Access your access point management page](#)" on page 27).
2. Click on **Upload Firmware** under **Management** from the left side menu. Please note, when clicking **Save**, the settings are saved but not applied yet.
3. Select the firmware file by clicking **Choose File**. The firmware file will have an extension of .bin.

## Firmware

Location

Choose File No file chosen

 GUI Emulator	6/6/2024 11:57 AM
 [Release] TRENDnetTEW-940APBO_V1.0.3...	1/30/2024 12:28 PM
 Firmware Upgrade Procedure.pdf	1/30/2024 12:32 PM
 FW TEW-940APBO TEW-940APBO2K_v1(...	1/30/2024 12:46 PM
 <b>TEW-940APBO_v1.0.3.07.bin</b>	1/30/2024 12:23 PM
 TRENDnet Firmware Release Notes.txt	1/30/2024 12:34 PM

4. A prompt will appear asking for confirmation of updating the firmware. Click **Apply** or **Okay** to begin the firmware update procedure.

**\*Note\*** Your device will automatically reboot following the firmware update.

**SSH***Management > SSH Management*

1. Log into your access point management page (see "[Access your access point management page](#)" on page 27).
2. Click on **SSH** under **Management** from the left side menu. Please note, when clicking **Save**, the settings are saved but not applied yet.
3. Select **SSH** to enable **Secure Shell Interface**. *Default: Disabled*

## SSH Management

SSH

Enabled

4. Click **Apply** to apply the settings and click **Save** the changes permanently to the flash by clicking the **Save** button in the top right corner.

Apply

**System Log***Management > Log*

1. Log into your access point management page (see "[Access your access point management page](#)" on page 27).
2. Click on **Log** under **Management** from the left side menu. Please note, when clicking **Save**, the settings are saved but not applied yet.



3. Select **Enabled** to enable system logging, or **Disabled** to disable it.
4. Input the IP Address in **Syslog Server IP Address** to where the log info should be saved.

System log	
Enable System Log	Enabled <span>▼</span>
Syslog Server IP Address	<input type="text"/>

5. Click **Apply** to apply the settings and click **Save** the changes permanently to the flash by clicking the **Save** button in the top right corner.



## Diagnostics

Management > Diagnostics

1. Log into your access point management page (see "[Access your access point management page](#)" on page 27).
2. Click on **Diagnostics** under **Management** from the left side menu. Please note, when clicking **Save**, the settings are saved but not applied yet.

### Ping Test Parameter

- **IP Address** – Input the IP Address for the unit to ping
- **Packet Length** – Input the length of the packet
- **Number of Pings** – Input the number of pings to send
- **Ping** – Click **Ping** to begin the ping test

### Ping Test Parameter

IP Address	<input type="text" value="192.168.10.200"/>
Packet Length	<input type="text" value="64"/>
Number of Pings	<input type="text" value="4"/>

Ping

### Traceroute Parameter

- **Target** - Enter the IP address or domain name of the traceroute target and click **Traceroute** to begin.

### Traceroute Parameter

Target	<input type="text" value="www.google.com"/>
--------	---

Traceroute

### Speed Test Parameter

- **Target IP / Domain Name** – Enter the IP address or domain name of the endpoint of the speed test.
- **Time Period** – Specify the duration of the speed test.
- **Check Interval** – Specify the interval between connectivity checks.
- **IPv4 Port** – Enter the IPv4 Port for the destination endpoint of the speed test.
- **IPv6 Port** – Enter the IPv6 Port for the destination endpoint of the speed test.
- Press **Speed** to begin the test.

Speed Test Parameter	
Target IP / Domain Name	<input type="text"/>
Time Period	<input type="text" value="10"/> Sec
Check Interval	<input type="text" value="1"/> Sec
IPv4 Port	5201
IPv6 Port	60001

[Speed](#)

## Technical Specifications

### Standards

- IEEE 802.3
- IEEE 802.3u
- IEEE 802.3ab
- IEEE 802.1d
- IEEE 802.1Q
- IEEE 802.1X
- IEEE 802.11a
- IEEE 802.11k
- IEEE 802.11n (5GHz: up to 300Mbps)\*
- IEEE 802.11ac (5GHz: up to 867Mbps)\*
- IEEE 802.11ax (5GHz: up to 1201Mbps)\*

### Hardware Interface

- 1 x Gigabit PoE-in LAN port (proprietary PoE max. cable length 60m (197 ft.))
- 1 x Gigabit LAN port
- LED indicators
- Reset button

### Features

- 802.11ax WiFi 6 support
- IP55 rated housing
- MU-MIMO
- Band steering
- Airtime fairness
- 802.1Q VLAN assignment per SSID
- IPv6 support
- LEDs on/off
- 802.11k intelligent radio resource management
- RSSI Threshold (client signal strength and connectivity control)
- LLDP
- Bonjour/UPnP

### Operation Modes

- Access Point
- Client Bridge
- Repeater

### Management/Monitoring

- Web based management (HTTP/HTTPS)
- Command Line Interface (SSH)
- SNMP v2c/v3
- Spanning Tree Protocol (STP)
- Event logging
- Ping test
- Traceroute
- Performance throughput test
- Schedule WiFi radio enable/disable
- Ping watchdog/gateway connection monitor
- Reboot & scheduled automatic reboot
- Channel utilization scan/AP detection

### Access Control

- Wireless encryption: OWE (Opportunistic Wireless Encryption), WPA/WPA2/WPA3-RADIUS (Enterprise), WPA-PSK/WPA2-PSK/WPA3-SAE (Personal)
- MAC filter (max entries: 32)
- Maximum client limit
- Client isolation/separate stations

### QoS

- WMM
- Bandwidth control per SSID

### SSID

- Up to 8 SSIDs

**Frequency**

- 5.150GHz – 5.250GHz, 5.725GHz – 5.850GHz

**Wireless Channels**

- 5 GHz: 36, 40, 44, 48, 149, 153, 157, 161, 165

**Modulation**

- BPSK/QPSK/16-QAM/64-QAM/256-QAM/1024-QAM for OFDM/OFDMA

**Antenna Gain**

- 14 dBi internal directional patch antenna

**Antenna Pattern**

- 5G Antenna 1

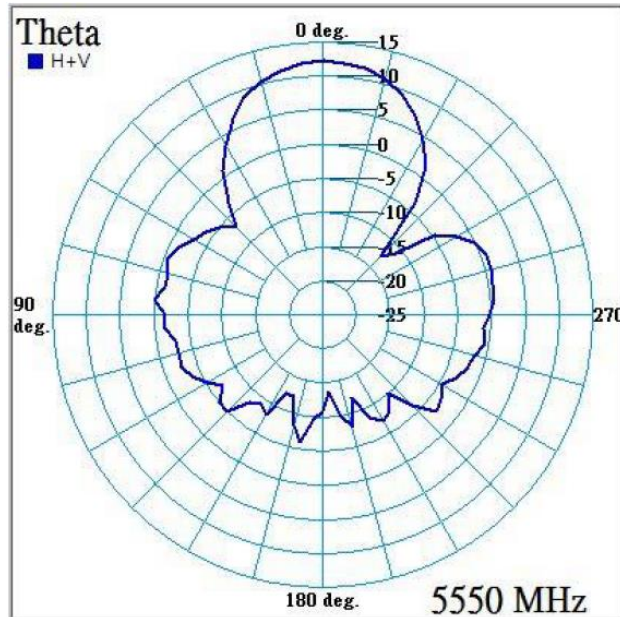

- 5G Antenna 2

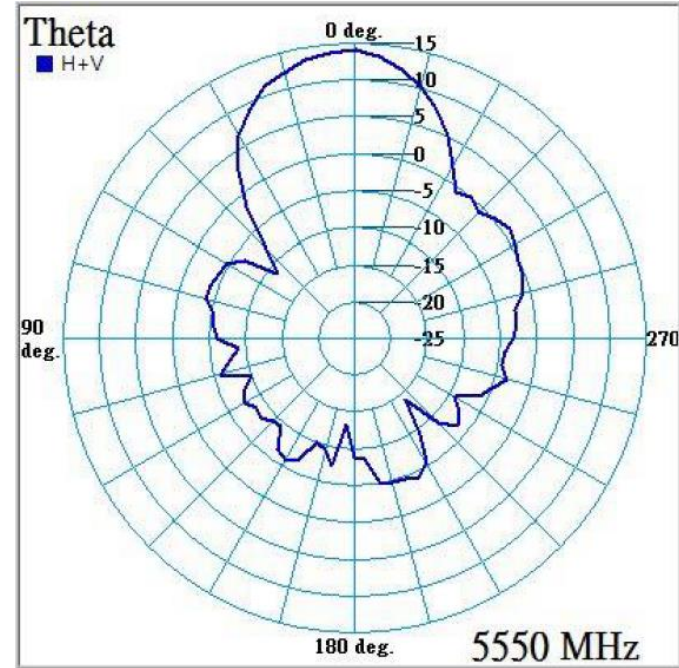

**Distance**

- Up to 1km\*\*

**Wireless Output Power**

- 802.11a: 23 dBm (max.)
- 802.11n: 22 dBm (max.)
- 802.11ac: 22 dBm (max.)
- 802.11ax: 22 dBm (max.)

**Receiving Sensitivity (per chain)**

- 802.11a: -71 dBm (typical) @ 54Mbps
- 802.11n: -66 dBm (typical) @ 300Mbps
- 802.11ac: -55 dBm (typical) @ 867Mbps

- 802.11ax: -54 dBm (typical) @ 1201Mbps

**Power**

- Input: 100 – 240V AC, 50/60Hz, 0.8A
- Output: 54V DC, 0.6A proprietary/passive PoE injector
- Max. Consumption: 10.1W

**Operating Temperature**

- -20° – 60° C (-4° – 140° F)

**Operating Humidity**

- Max. 90% non-condensing

**Certifications**

- FCC
- IC

**Dimensions**

- 82 x 257 x 50mm (7.3 x 3.9 x 1.4 in.)

**Weight**

- 598g (21.09 oz.)

**Warranty**

- 3 year

**Package Contents**

- TEW-940APBO
- Quick Installation Guide
- Proprietary/Passive PoE injector (54V DC, 0.6A)
- Mounting hardware

**Disclaimer**

\* Effective wireless coverage may vary depending on the wireless device's output power, antenna gain, antenna alignment, receiving sensitivity, and radio interference. Additionally, environmental factors such as weather conditions, physical obstacles, and other considerations may affect performance. For optimal results, we recommended consulting a professional installer for site survey, safety precautions, and proper installation.

## Appendix

### How to find your IP address?

**Note:** Please note that although the following procedures provided to follow for your operating system on configuring your network settings can be used as general guidelines, however, it is strongly recommended that you consult your computer or operating system manufacturer directly for assistance on the proper procedure for configuring network settings.

#### Command Prompt Method

##### **Windows 7/8.1/10/11**

1. On your keyboard, press **Windows Logo+R** keys simultaneously to bring up the Run dialog box.
2. In the dialog box, type **cmd** to bring up the command prompt.
3. In the command prompt, type **ipconfig /all** to display your IP address settings.

##### **MAC OS X**

1. Navigate to your **Applications** folder and open **Utilities**.
2. Double-click on **Terminal** to launch the command prompt.
3. In the command prompt, type **ipconfig getifaddr <en0 or en1>** to display the wired or wireless IP address settings.

**Note:** **en0** is typically the wired Ethernet and **en1** is typically the wireless Airport interface.

#### Graphical Method

##### **MAC OS 10.6/10.5**

1. From the Apple menu, select **System Preferences**.
2. In System Preferences, from the **View** menu, select **Network**.
3. In the Network preference window, click a network port (e.g., Ethernet, AirPort, modem). If you are connected, you'll see your IP address settings under "Status:"

##### **MAC OS 10.4**

1. From the Apple menu, select **Location**, and then **Network Preferences**.
2. In the Network Preference window, next to "Show:", select **Network Status**. You'll see your network status and your IP address settings displayed.

**Note:** If you are experiencing difficulties, please contact your computer or operating system manufacturer for assistance.

### How to configure your network settings to obtain an IP address automatically or use DHCP?

**Note:** Please note that although the following procedures provided to follow for your operating system on configuring your network settings can be used as general guidelines, however, it is strongly recommended that you consult your computer or operating system manufacturer directly for assistance on the proper procedure for configuring network settings.

##### **Windows 7/8.1/10/11**

- a. Go into the **Control Panel**, click **Network and Sharing Center**.
- b. Click **Change Adapter Settings**, right-click the **Local Area Connection** icon.
- c. Then click **Properties** and click **Internet Protocol Version 4 (TCP/IPv4)**.
- d. Then click **Obtain an IP address automatically** and click **OK**.

##### **MAC OS 10.4/10.5/10.6**

- a. From the **Apple**, drop-down list, select **System Preferences**.
- b. Click the **Network** icon.
- c. From the **Location** drop-down list, select **Automatic**.
- d. Select and view your Ethernet connection.
  - In MAC OS 10.4, from the **Show** drop-down list, select **Built-in Ethernet** and select the **TCP/IP** tab.
  - In MAC OS 10.5/10.6, in the left column, select **Ethernet**.
- e. Configure TCP/IP to use DHCP.
  - In MAC 10.4, from the **Configure IPv4**, drop-down list, select **Using DHCP** and click the **Apply Now** button.
  - In MAC 10.5, from the **Configure** drop-down list, select **Using DHCP** and click the **Apply** button.
  - In MAC 10.6, from the **Configure** drop-down list, select **Using DHCP** and click the **Apply** button.
- f. Restart your computer.

**Note:** If you are experiencing difficulties, please contact your computer or operating system manufacturer for assistance.

### How to configure your network settings to use a static IP address?

**Note:** Please note that although the following procedures provided to follow for your operating system on configuring your network settings can be used as general guidelines, however, it is strongly recommended that you consult your computer or operating system manufacturer directly for assistance on the proper procedure for configuring network settings.

#### Windows 7/8.1/10/11

- a. Go into the **Control Panel**, click **Network and Sharing Center**.
- b. Click **Change Adapter Settings**, right-click the **Local Area Connection** icon.
- c. Then click **Properties** and click **Internet Protocol Version 4 (TCP/IPv4)**.
- d. Then click **Use the following IP address**, and assign your network adapter a static IP address. Click **OK**

#### MAC OS 10.4/10.5/10.6

- a. From the **Apple**, drop-down list, select **System Preferences**.
- b. Click the **Network** icon.
- c. From the **Location** drop-down list, select **Automatic**.
- d. Select and view your Ethernet connection.

### How to find your MAC address?

In Windows 2000/XP/Vista/7/8,

Your computer MAC addresses are also displayed in this window, however, you can type **getmac -v** to display the MAC addresses only.

In MAC OS 10.4,

1. **Apple Menu > System Preferences > Network**
2. From the **Show** menu, select **Built-in Ethernet**.
3. On the **Ethernet** tab, the **Ethernet ID** is your MAC Address.

In MAC OS 10.5/10.6,

1. **Apple Menu > System Preferences > Network**
2. Select **Ethernet** from the list on the left.
3. Click the **Advanced** button.

3. On the **Ethernet** tab, the **Ethernet ID** is your MAC Address.

### How do I use the ping tool to check for network device connectivity?

#### Windows 7/8.1/10/11

1. On your keyboard, press **Windows Logo+R** keys simultaneously to bring up the Run dialog box.
2. In the dialog box, type **cmd** to bring up the command prompt.
3. In the command prompt, type **ping <ip\_address>** with the *<ip\_address>* being the IP address you want ping and check for connectivity.

**Example:** Usage of ping command and successful replies from device.

```
C:\Users>ping 192.168.10.100
```

```
Pinging 192.168.10.100 with 32 bytes of data:
```

```
Reply from 192.168.10.100: bytes=32 time<1ms TTL=64
```

```
Reply from 192.168.10.100: bytes=32 time<1ms TTL=64
```

```
Reply from 192.168.10.100: bytes=32 time<1ms TTL=64
```

```
Reply from 192.168.10.100: bytes=32 time<1ms TTL=64
```

```
Ping statistics for 192.168.10.100:
```

```
    Packets: Sent = 4, Received = 4, Lost = 0 (0% loss),
```

```
Approximate round trip times in milli-seconds:
```

```
    Minimum = 0ms, Maximum = 0ms, Average = 0ms
```

#### MAC OS X



1. Navigate to your **Applications** folder and open **Utilities**.
2. Double-click on **Terminal** to launch the command prompt.
3. In the command prompt, type **ping -c <#> <ip\_address>** with the *<#>* ping being the number of time you want to ping and the *<ip\_address>* being the IP address you want ping and check for connectivity.

**Example:** `ping -c 4 192.168.10.100`

### How to connect to a wireless network using the built-in Windows utility?

**Note:** Please note that although the following procedures provided to follow for your operating system on configuring your network settings can be used as general guidelines, however, it is strongly recommended that you consult your computer or operating system manufacturer directly for assistance on the proper procedure for connecting to a wireless network using the built-in utility.

#### Windows 7/8.1/10/11

1. Open Connect to a Network by clicking the network icon ( or ) in the notification area.
2. In the list of available wireless networks, click the wireless network you would like to connect to, then click **Connect**.
4. You may be prompted to enter a security key in order to connect to the network.
5. Enter in the security key corresponding to the wireless network, and click **OK**.



### Federal Communication Commission Interference Statement

This equipment has been tested and found to comply with the limits for a Class B digital device, pursuant to Part 15 of the FCC Rules. These limits are designed to provide reasonable protection against harmful interference in a residential installation. This equipment generates, uses and can radiate radio frequency energy and, if not installed and used in accordance with the instructions, may cause harmful interference to radio communications. However, there is no guarantee that interference will not occur in a particular installation. If this equipment does cause harmful interference to radio or television reception, which can be determined by turning the equipment off and on, the user is encouraged to try to correct the interference by one of the following measures:

- Reorient or relocate the receiving antenna.
- Increase the separation between the equipment and receiver.
- Connect the equipment into an outlet on a circuit different from that to which the receiver is connected.
- Consult the dealer or an experienced radio/TV technician for help.



FCC Caution: Any changes or modifications not expressly approved by the party responsible for compliance could void the user's authority to operate this equipment.

This device complies with Part 15 of the FCC Rules. Operation is subject to the following two conditions: (1) This device may not cause harmful interference, and (2) this device must accept any interference received, including interference that may cause undesired operation.

#### IMPORTANT NOTE:

##### Radiation Exposure Statement:

This equipment complies with FCC radiation exposure limits set forth for an uncontrolled environment. This equipment should be installed and operated with minimum distance 20cm between the radiator & your body.

This transmitter must not be co-located or operating in conjunction with any other antenna or transmitter.

Country Code selection feature to be disabled for products marketed to the US/CANADA

### Industry Canada Statement

This device complies with Industry Canada license-exempt RSS standard(s). Operation is subject to the following two conditions: (1) this device may not cause interference, and (2) this device must accept any interference, including interference that may cause undesired operation of the device.

*Le présent appareil est conforme aux CNR d'Industrie Canada applicables aux appareils radio exempts de licence. L'exploitation est autorisée aux deux conditions suivantes : (1) l'appareil ne doit pas produire de brouillage, et (2) l'utilisateur de l'appareil doit accepter tout brouillage radioélectrique subi, même si le brouillage est susceptible d'en compromettre le fonctionnement.*

##### Radiation Exposure Statement:

This equipment complies with IC radiation exposure limits set forth for an uncontrolled environment. This equipment should be installed and operated with minimum distance 20cm between the radiator & your body.

##### Déclaration d'exposition aux radiations:

Cet équipement est conforme aux limites d'exposition aux rayonnements IC établies pour un environnement non contrôlé. Cet équipement doit être installé et utilisé avec un minimum de 20 cm de distance entre la source de rayonnement et votre corps.

## Limited Warranty

---

TRENDnet warrants only to the original purchaser of this product from a TRENDnet authorized reseller or distributor that this product will be free from defects in material and workmanship under normal use and service. This limited warranty is non-transferable and does not apply to any purchaser who bought the product from a reseller or distributor not authorized by TRENDnet, including but not limited to purchases from Internet auction sites.

### Limited Warranty

TRENDnet warrants its products against defects in material and workmanship, under normal use and service. Specific warranty periods are listed on each of the respective product pages on the TRENDnet website.

- AC/DC Power Adapter, Cooling Fan, and Power Supply carry a one-year warranty.

### Limited Lifetime Warranty

TRENDnet offers a limited lifetime warranty for all of its metal-enclosed network switches that have been purchased in the United States/Canada on or after 1/1/2015.

- Cooling fan and internal power supply carry a one-year warranty

To obtain an RMA, the ORIGINAL PURCHASER must show Proof of Purchase and return the unit to the address provided. The customer is responsible for any shipping-related costs that may occur. Replacement goods will be shipped back to the customer at TRENDnet's expense.

Upon receiving the RMA unit, TRENDnet may repair the unit using refurbished parts. In the event that the RMA unit needs to be replaced, TRENDnet may replace it with a refurbished product of the same or comparable model.

In the event that, after evaluation, TRENDnet cannot replace the defective product or there is no comparable model available, we will refund the depreciated value of the product.

If a product does not operate as warranted during the applicable warranty period, TRENDnet shall reserve the right, at its expense, to repair or replace the defective product or part and deliver an equivalent product or part to the customer. The repair/replacement unit's warranty continues from the original date of purchase. All products that are replaced become the property of TRENDnet. Replacement products may be new or reconditioned. TRENDnet does not issue refunds or credit. Please contact the point-of-purchase for their return policies.

TRENDnet shall not be responsible for any software, firmware, information, or memory data of customer contained in, stored on, or integrated with any products returned to TRENDnet pursuant to any warranty.

There are no user serviceable parts inside the product. Do not remove or attempt to service the product by any unauthorized service center. This warranty is voided if (i) the product has been modified or repaired by any unauthorized service center, (ii) the product was subject to accident, abuse, or improper use, or (iii) the product was subject to conditions more severe than those specified in the manual.

Warranty service may be obtained by contacting TRENDnet within the applicable warranty period and providing a copy of the dated proof of the purchase. Upon proper submission of required documentation, a Return Material Authorization (RMA) number will be issued. An RMA number is required in order to initiate warranty service support for all TRENDnet products. Products that are sent to TRENDnet for RMA service must have the RMA number marked on the outside of return packages and sent to TRENDnet prepaid, insured and packaged appropriately for safe shipment. International customers

shipping from outside of the USA and Canada are responsible for any return shipping and/or customs charges, including but not limited to, duty, tax, and other fees.

**Refurbished product:** Refurbished products carry a 90-day warranty after date of purchase. Please retain the dated sales receipt with purchase price clearly visible as evidence of the original purchaser's date of purchase. Replacement products may be refurbished or contain refurbished materials. If TRENDnet, by its sole determination, is unable to replace the defective product, we will offer a refund for the depreciated value of the product.

**WARRANTIES EXCLUSIVE:** IF THE TRENDNET PRODUCT DOES NOT OPERATE AS WARRANTED ABOVE, THE CUSTOMER'S SOLE REMEDY SHALL BE, AT TRENDNET'S OPTION, REPAIR OR REPLACE. THE FOREGOING WARRANTIES AND REMEDIES ARE EXCLUSIVE AND ARE IN LIEU OF ALL OTHER WARRANTIES, EXPRESSED OR IMPLIED, EITHER IN FACT OR BY OPERATION OF LAW, STATUTORY OR OTHERWISE, INCLUDING WARRANTIES OF MERCHANTABILITY AND FITNESS FOR A PARTICULAR PURPOSE. TRENDNET NEITHER ASSUMES NOR AUTHORIZES ANY OTHER PERSON TO ASSUME FOR IT ANY OTHER LIABILITY IN CONNECTION WITH THE SALE, INSTALLATION, MAINTENANCE, OR USE OF TRENDNET'S PRODUCTS.

TRENDNET SHALL NOT BE LIABLE UNDER THIS WARRANTY IF ITS TESTING AND EXAMINATION DISCLOSE THAT THE ALLEGED DEFECT IN THE PRODUCT DOES NOT EXIST OR WAS CAUSED BY CUSTOMER'S OR ANY THIRD PERSON'S MISUSE, NEGLIGENCE, IMPROPER INSTALLATION OR TESTING, UNAUTHORIZED ATTEMPTS TO REPAIR OR MODIFY, OR ANY OTHER CAUSE BEYOND THE RANGE OF THE INTENDED USE, OR BY ACCIDENT, FIRE, LIGHTNING, OR OTHER HAZARD.

LIMITATION OF LIABILITY: TO THE FULL EXTENT ALLOWED BY LAW, TRENDNET ALSO EXCLUDES FOR ITSELF AND ITS SUPPLIERS ANY LIABILITY, WHETHER BASED IN

CONTRACT OR TORT (INCLUDING NEGLIGENCE), FOR INCIDENTAL, CONSEQUENTIAL, INDIRECT, SPECIAL, OR PUNITIVE DAMAGES OF ANY KIND, OR FOR LOSS OF REVENUE OR PROFITS, LOSS OF BUSINESS, LOSS OF INFORMATION OR DATE, OR OTHER FINANCIAL LOSS ARISING OUT OF OR IN CONNECTION WITH THE SALE, INSTALLATION, MAINTENANCE, USE, PERFORMANCE, FAILURE, OR INTERRUPTION OF THE POSSIBILITY OF SUCH DAMAGES, AND LIMITS ITS LIABILITY TO REPAIR, REPLACEMENT, OR REFUND OF THE PURCHASE PRICE PAID, AT TRENDNET'S OPTION. THIS DISCLAIMER OF LIABILITY FOR DAMAGES WILL NOT BE AFFECTED IF ANY REMEDY PROVIDED HEREIN SHALL FAIL OF ITS ESSENTIAL PURPOSE.

**Governing Law:** This Limited Warranty shall be governed by the laws of the state of California.

Some TRENDnet products include software code written by third party developers. These codes are subject to the GNU General Public License ("GPL") or GNU Lesser General Public License ("LGPL").

Visit <http://www.trendnet.com/gpl> or the support section on <http://www.trendnet.com> and search for the desired TRENDnet product to access to the GPL Code or LGPL Code. These codes are distributed WITHOUT WARRANTY and are subject to the copyrights of the developers. TRENDnet does not provide technical support for these codes. Please visit <http://www.gnu.org/licenses/gpl.txt> or <http://www.gnu.org/licenses/lgpl.txt> for specific terms of each license.

PWP07172015v3

2016/12/12



## Product Warranty Registration

Please take a moment to register your product online.  
Go to TRENDnet's website at <http://www.trendnet.com/register>

TRENDnet  
20675 Manhattan Place  
Torrance, CA 90501. USA