

TRENDnet[®]

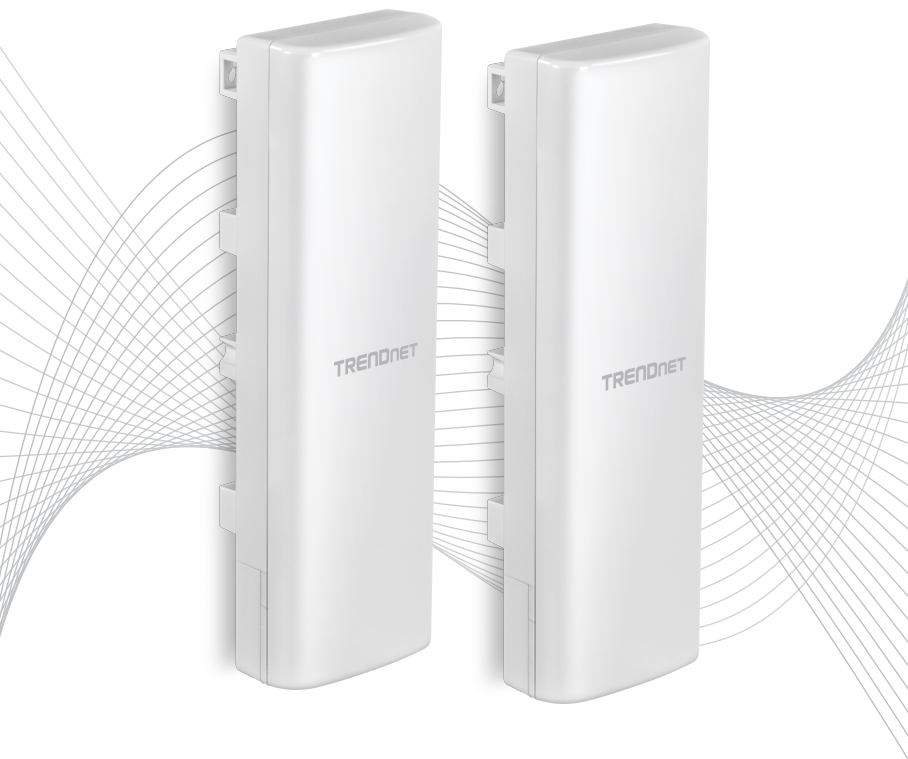

Quick Installation Guide
TEW-940APB02K (v1.xR)

1. Before You Start

Package Contents

- 2 x TEW-940APBO
- Quick Installation Guide
- 2 x Proprietary/Passive PoE injectors (54V DC, 0.6A)
- Mounting Hardware

Minimum Requirements

- Computer with a network port and web browser
- A network switch or router with an available network LAN port
- 4 x RJ-45 network cables
- Power drill and Phillips bit or Phillips screwdriver for mounting
- Flat head bit or screwdriver for pole mounting clamp

Note: The TEW-940APBO does not support IEEE 802.3at/af PoE standards. You must use the proprietary/passive power over Ethernet injector that is supplied with the TEW-940APBO. This installation guide will walk you through the installation and configuration of two TEW-940APBO access points to establish a wireless point-to-point bridge using one in access point mode and the other using client bridge mode. The RJ-45 Ethernet cable between the passive PoE injector and access point can have a maximum length of up to 60 m (197 ft.).

IMPORTANT NOTE: The device can be reset from both the hardware reset button located on the device under the panel or on the included passive PoE injector. To reset the access point to factory default, make sure the access point is connected and powered on using the included passive PoE injector, then push and hold the reset button on either the access point or injector for 15 seconds and release.

2. Hardware Setup and Configuration

The TEW-940APB0 access points will be configured using the following settings:

TEW-940APB0 #1

IP Address: 192.168.10.50

Netmask (Subnet Mask): 255.255.255.0

IP Gateway (Default Gateway): 0.0.0.0

Primary DNS: 0.0.0.0

Operation Mode: Access Point

Wireless Security: WPA3-SAE AES Encryption

TEW-940APB0 #2

IP Address: 192.168.10.51

Netmask (Subnet Mask): 255.255.255.0

IP Gateway (Default Gateway): 0.0.0.0

Primary DNS: 0.0.0.0

Operation Mode: Client Bridge

Wireless Security: WPA3-SAE AES Encryption

1. Remove the cover of the access point by pulling and holding the bottom tab at the bottom of the access point and from the back side slide the cover below away from the access point.

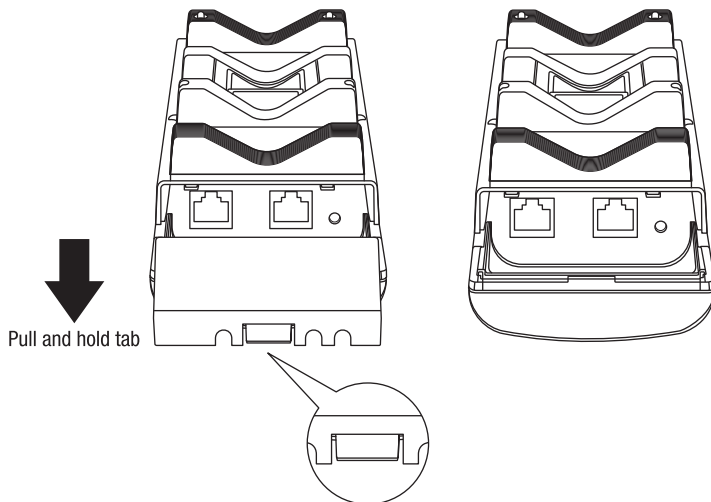

Note: By default, the TEW-940APBO access points are preconfigured to establish a point-to-point wireless bridge connection between each other using a unique predefined WPA3-SAE AES encryption key. For convenience, a unique predefined admin password has already been assigned to both access points. You can find the preconfigured access point settings on the device label beneath the cover where the Ethernet ports are located. No additional configuration is required.

Unit 1**TRENDnet®**

Ap1
 Model: TEW-940APB0 /A
 IP Address: 192.168.10.50
 Subnet Mask: 255.255.255.0
 User Name: admin
 Password: XXXXXXXX
 Ap1 Mode: Access Point
 Ap1 SSID: TRENDnet940_XXXX
 Ap1 WPA2 Key: 940XXXXXXXXX

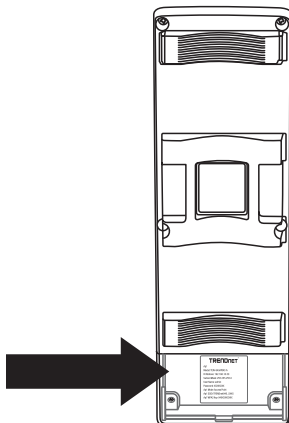
**Unit 2****TRENDnet®**

Ap2
 Model: TEW-940APB0 /A
 IP Address: 192.168.10.51
 Subnet Mask: 255.255.255.0
 User Name: admin
 Password: XXXXXXXX
 Ap1 Mode: Access Point
 Ap1 SSID: TRENDnet940_XXXX
 Ap1 WPA2 Key: 940XXXXXXXXX

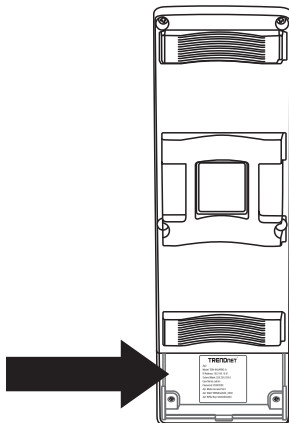
**Important Note:**

Verify connectivity between the two access points before mounting.

2. Using a network cable, connect one end of the cable to the Main LAN (PoE) port.

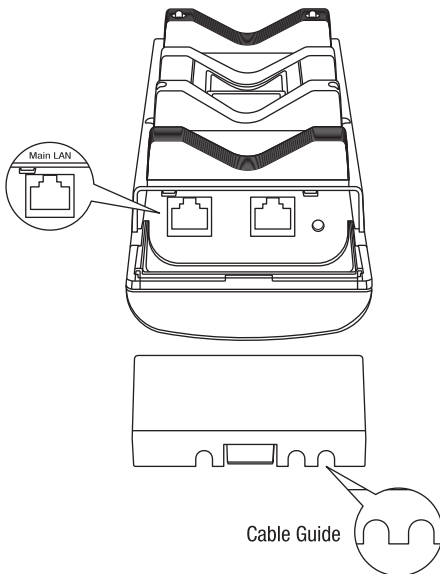

3. Connect the other end of the network cable to the **PoE** port on the included PoE injector.
4. Attach the power cord to the PoE injector and plug the connected power cord into a power outlet.

5. Confirm the device is powered on through the LED indicators. Please refer to the LED definition table below.

LED	Status	Description
PWR	Solid Green	Device is receiving power
LAN	Solid Green	1G Data link established
	Solid Orange	100M/10M Data link established
	Blinking	Data transmission
WLAN	Solid Green	5GHz radio is enabled
	Blinking	Data transmission
Link Quality (Only functions if TEW-940APBO is in Client Bridge operation mode)	Solid Green (Best)	When connected to remote wireless access point in client bridge mode, indicates wireless connection quality.
	Solid Orange (Better)	
	Solid Red (Good)	

Note: Repeat steps 1-5 to power on and connect the second access point.

6. Assign a static IP address to your computer's network adapter in the subnet of **192.168.10.x** (e.g. 192.168.10.25) and subnet mask of **255.255.255.0**. For more information on assigning a static IP address to your computer's network adapter, please refer to item Q1 in the last section of the installation guide, Installation Tips and Troubleshooting.
7. Using another network cable, connect one end of the LAN port on the included PoE injector for either the first or second access point.

8. Connect the other end of the network cable to your computer's Ethernet port.

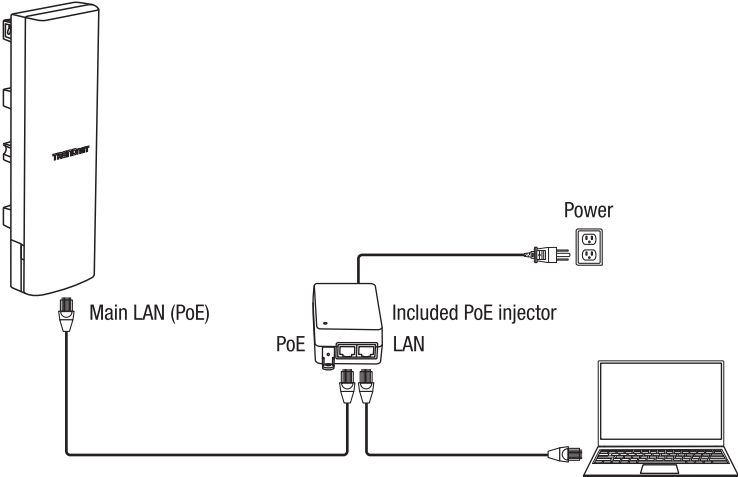

9. Make sure both access points are powered on approximately 15 ft. (5 m) apart from one another with the front of the access points directly facing each other.

TEW-940APB0 #1

TEW-940APB0 #2

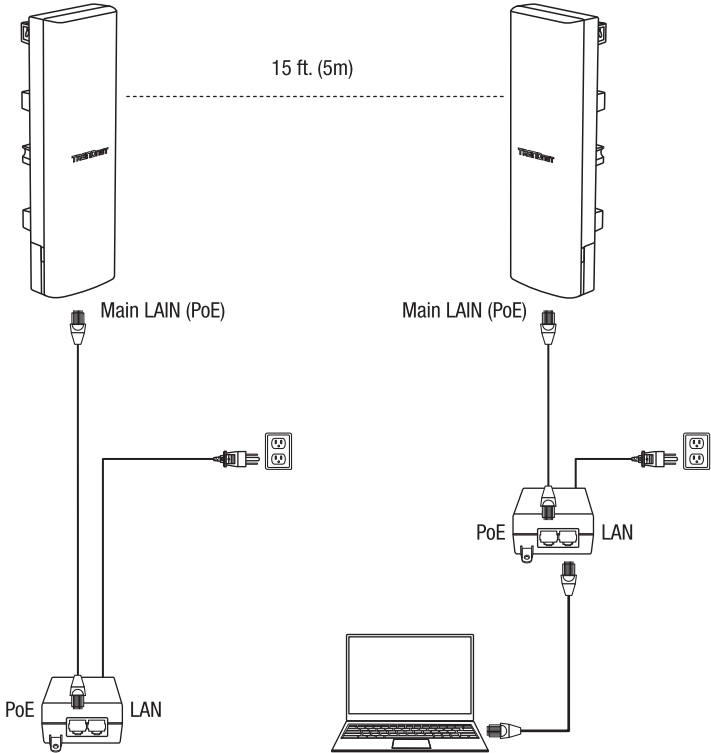

10. To verify connectivity on your computer, open a command prompt or terminal application window and type in the following commands.

Note: In Windows®, you can use the Command Prompt application and in Mac®, you can use the Terminal application to run the commands for connectivity testing.

```
ping 192.168.10.50
```

<Press Enter and wait for result>

```
ping 192.168.10.51
```

<Press Enter and wait for result>

11. A successful connectivity test will appear similar to the result below for each access point. Ping replies and 0% packet loss will indicate a successful point to point bridge connection between the two access points.

Note: If the connectivity test fails, wait for about 1 minute and try again. Make sure there are no obstacles between the two access points when running the connectivity test and make sure the access points are not too close together.

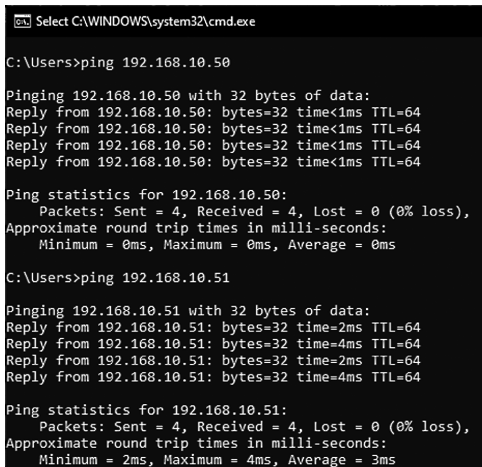

```
Select C:\WINDOWS\system32\cmd.exe

C:\Users>ping 192.168.10.50

Pinging 192.168.10.50 with 32 bytes of data:
Reply from 192.168.10.50: bytes=32 time<1ms TTL=64
Reply from 192.168.10.50: bytes=32 time<1ms TTL=64
Reply from 192.168.10.50: bytes=32 time<1ms TTL=64
Reply from 192.168.10.50: bytes=32 time<1ms TTL=64

Ping statistics for 192.168.10.50:
    Packets: Sent = 4, Received = 4, Lost = 0 (0% loss),
    Approximate round trip times in milli-seconds:
        Minimum = 0ms, Maximum = 0ms, Average = 0ms

C:\Users>ping 192.168.10.51

Pinging 192.168.10.51 with 32 bytes of data:
Reply from 192.168.10.51: bytes=32 time=2ms TTL=64
Reply from 192.168.10.51: bytes=32 time=4ms TTL=64
Reply from 192.168.10.51: bytes=32 time=2ms TTL=64
Reply from 192.168.10.51: bytes=32 time=4ms TTL=64

Ping statistics for 192.168.10.51:
    Packets: Sent = 4, Received = 4, Lost = 0 (0% loss),
    Approximate round trip times in milli-seconds:
        Minimum = 2ms, Maximum = 4ms, Average = 3ms
```

3. Mounting

1. Route the Ethernet cable through one of the cable openings and reinstall the cover.

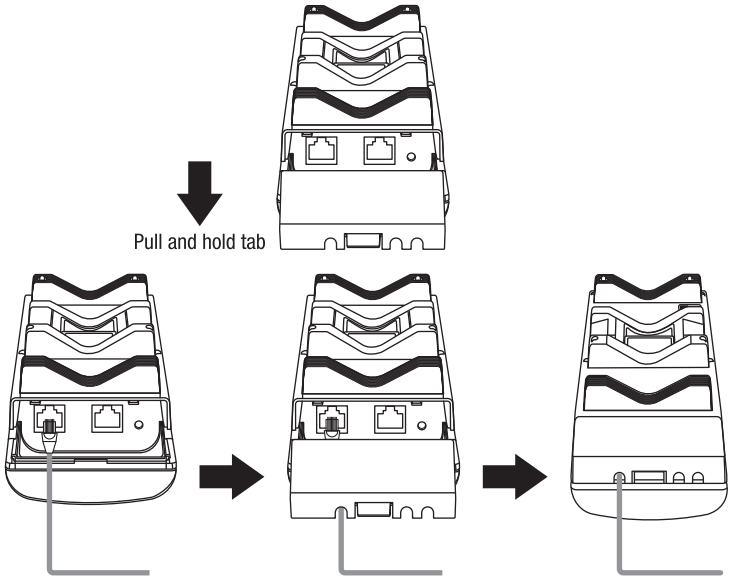

2. Loosen and open the pole mounting clamp using a flat head screwdriver or power drill turning the screw counter clockwise.

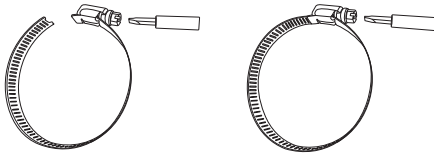

3. Insert the pole mounting clamp into the two openings at the back of the access point.

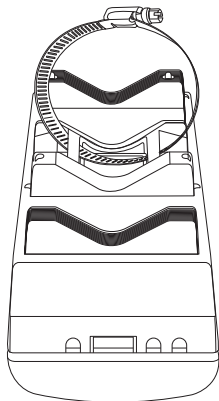

4. Secure the access point to the mounting location by turning the mounting clamp screw clockwise.

Note: When access point is set to Client Bridge mode operation, the TEW-940APBO features WiFi link/connection quality LEDs located on the back of the access point to assist in determining the optimal mounting position. (Red = Good, Orange = Better, Green = Best)

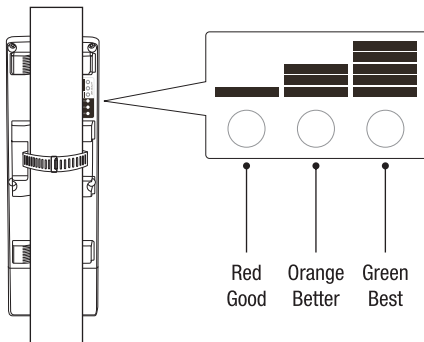

TEW-940APB0 #1

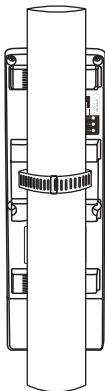

TEW-940APB0 #2

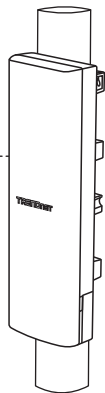
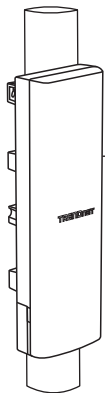
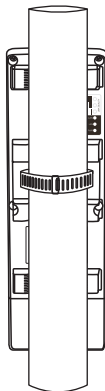

15 ft. (5m)

Note: Please make sure that the access points are mounted with the same vertical height, with clear line of sight, and facing the direction of each other to allow for optimal connectivity. The link quality LED on the access point configured in client bridge may assist in the optimal mounting position.

Completed Installation Reference

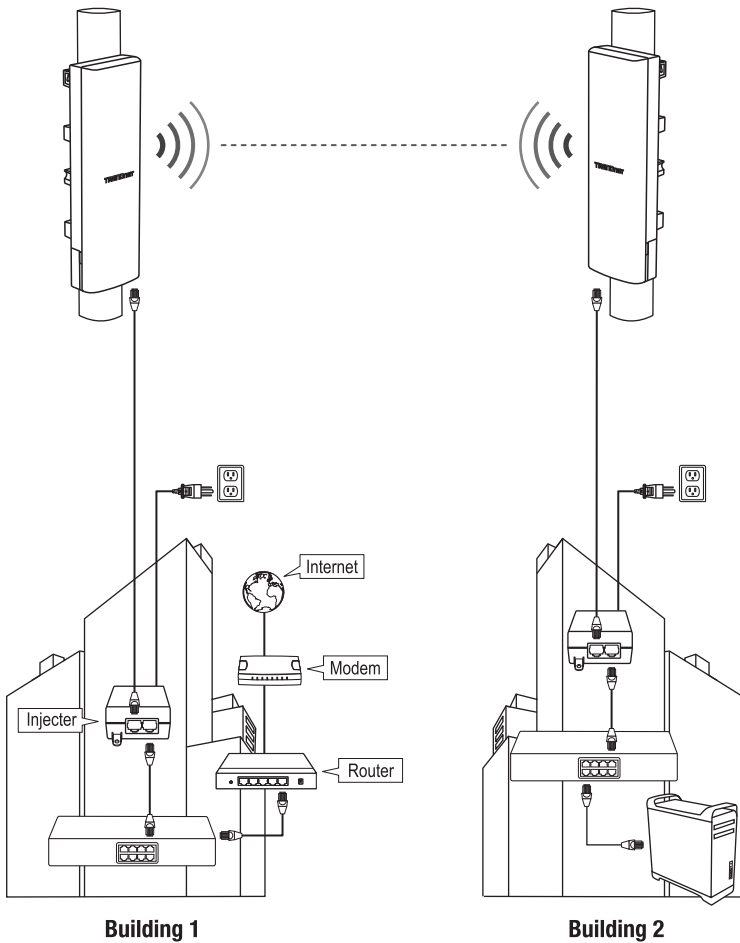

Installation Tips and Troubleshooting

Q1: How do I configure my computer's network adapter with a static IP address?

Note: Please note that although the following procedures are provided to follow for your operating system network adapter settings to be used as general guidelines, however, it is strongly recommended that you consult your computer or operating system manufacturer directly for assistance on the proper procedure for configuring network settings. If you are experiencing difficulties, please contact your computer or operating system manufacturer for assistance.

Windows 2000/XP/Vista/7/8/8.1/10/11

1. On your keyboard, press **Windows Logo + R** keys simultaneously to bring up the Run dialog box.
2. In the dialog box, type **ncpa.cpl** to bring up the Network Connections window.
3. Right-click the **Local Area Connection** or **Ethernet** icon, click **Properties**, and double-click **Internet Protocol Version 4 (TCP/IPv4)**.
4. Then click **Use the following IP address** and assign your network adapter a static IP address. See example static IP address settings below.
 - IP address: 192.168.10.25
 - Subnet mask: 255.255.255.0
5. Click **OK** on both TCP/IPv4 Properties and Local Area Connection Properties windows.

MAC OS X

1. From the **Apple** drop-down list, select **System Preferences**.
2. Click the **Network** icon.
3. From the **Location** drop-down list, select **Automatic**.
4. Select and view your Ethernet connection.
 - For MAC OS 10.4, from the **Show** drop-down list, select **Built-in Ethernet** and select the **TCP/IP** tab.
 - For MAC OS 10.5 and above, in the left column, select **Ethernet**.
5. Configure TCP/IP to use a static IP.
 - From the **Configure IPv4** or **Configure** drop-down list, select **Manually** and assign your network adapter a static IP address. Then click the **Apply** or **Apply Now** button. See example static IP address settings below.
 - IP address: 192.168.10.25
 - Subnet mask: 255.255.255.0
6. You may be prompted to restart your computer to apply the new IP address settings.

Q2: I configured my computer's network adapter with a static IP address, how do I reconfigure my computer's network adapter to default settings and obtain an IP address automatically using DHCP?

Note: Please note that although the following procedures are provided to follow for your operating system network adapter settings to be used as general guidelines, however, it is strongly recommended that you consult your computer or operating system manufacturer directly for assistance on the proper procedure for configuring network settings. If you are experiencing difficulties, please contact your computer or operating system manufacturer for assistance.

Windows 2000/XP/Vista/7/8/8.1/10/11

1. On your keyboard, press **Windows Logo + R** keys simultaneously to bring up the Run dialog box.
2. In the dialog box, type **ncpa.cpl** to bring up the Network Connections window.
3. Right-click the **Local Area Connection** or **Ethernet** icon, click **Properties**, and double-click **Internet Protocol Version 4 (TCP/IPv4)**.
4. Then click **Obtain an IP address automatically** and **Obtain DNS server address automatically**.
5. Click **OK** on both TCP/IPv4 Properties and Local Area Connection Properties windows.

MAC OS X

1. From the **Apple** drop-down list, select **System Preferences**.
2. Click the **Network** icon.
3. From the **Location** drop-down list, select **Automatic**.
4. Select and view your Ethernet connection.
 - In MAC OS 10.4, from the **Show** drop-down list, select **Built-in Ethernet** and select the **TCP/IP** tab.
 - In MAC OS 10.5 and above, in the left column, select **Ethernet**.
5. Configure TCP/IP to use a static IP.
 - From the **Configure IPv4** or **Configure** drop-down list, select **Using DHCP** and click the **Apply** or **Apply Now** button.
6. You may be prompted to restart your computer to apply the new IP address settings.

Q3: I typed `http://192.168.10.100` in my Internet Browser Address Bar, but an error message says “The page cannot be displayed.” How can I access the wireless access point management page?

1. Double check all physical cable and port connections.
2. Make sure the PWR/LAN/2.4GHz/5GHz LEDs on the wireless access point front panel are on.
3. Make sure your computer's network adapter is configured with a static IP address. (Refer to Q1 for instructions on assigning a static IP address).
4. Make sure your computer is connected to the access point network LAN port and LAN LED is on.
5. Since the access point default IP address is 192.168.10.100, make sure there are no other network devices assigned an IP address of 192.168.10.100

Note: After checking all of the recommended items above, please attempt to access the wireless access point management page again.

Q4: How do I find the current IP address of my computer's network adapter?

Note: Please note that although the following procedures are provided to follow for your operating system network adapter settings to be used as general guidelines, however, it is strongly recommended that you consult your computer or operating system manufacturer directly for assistance on the proper procedure for configuring network settings. If you are experiencing difficulties, please contact your computer or operating system manufacturer for assistance.

Command Prompt Method

Windows 2000/XP/Vista/7/8/8.1/10/11

1. On your keyboard, press **Windows Logo + R** keys simultaneously to bring up the Run dialog box.
2. In the dialog box, type **cmd** to bring up the command prompt.
3. In the command prompt, type **ipconfig /all** to display your IP address settings.

MAC OS X

1. Navigate to your **Applications** folder and open Utilities.
2. Double-click on **Terminal** to launch the command prompt.
3. In the command prompt, type **ipconfig getifaddr <en0 or en1>** to display the wired or wireless IP address settings.

Note: **en0** is typically the wired Ethernet and **en1** is typically the wireless Airport interface.

Graphical Method

Windows XP/Vista/7/8/8.1/10/11

1. On your keyboard, press **Windows Logo + R** keys simultaneously to bring up the Run dialog box.
2. In the dialog box, type **ncpa.cpl** to bring up the Network Connections window.
3. Double-click the Local Area Connection icon and click the Details button to view the current IP address settings.

Note: The computer's network adapter must be enabled and connected to view the current IP address settings.

MAC OS X

1. From the **Apple** menu, select **System Preferences**.
2. In System Preferences, from the **View** menu, select **Network**.
3. In the Network preference window, click a network port (e.g., Ethernet, AirPort, modem). If you are connected, you'll see your IP address settings under "Status:"

Federal Communication Commission Interference Statement

This device complies with Part 15 of the FCC Rules. Operation is subject to the following two conditions:

(1) This device may not cause harmful interference, and (2) this device must accept any interference received, including interference that may cause undesired operation.

This equipment has been tested and found to comply with the limits for a Class B digital device, pursuant to Part 15 of the FCC Rules. These limits are designed to provide reasonable protection against harmful interference in a residential installation. This equipment generates, uses and can radiate radio frequency energy and, if not installed and used in accordance with the instructions, may cause harmful interference to radio communications. However, there is no guarantee that interference will not occur in a particular installation. If this equipment does cause harmful interference to radio or television reception, which can be determined by turning the equipment off and on, the user is encouraged to try to correct the interference by one of the following measures:

- Reorient or relocate the receiving antenna.
- Increase the separation between the equipment and receiver.
- Connect the equipment into an outlet on a circuit different from that to which the receiver is connected.
- Consult the dealer or an experienced radio/TV technician for help.

FCC Caution: Any changes or modifications not expressly approved by the party responsible for compliance could void the user's authority to operate this equipment.

This transmitter must not be co-located or operating in conjunction with any other antenna or transmitter.

IMPORTANT NOTE:

Radiation Exposure Statement:

This equipment complies with FCC radiation exposure limits set forth for an uncontrolled environment. This equipment should be installed and operated with minimum distance 20cm between the radiator & your body.

No.	Type	Connector	Gain (dBi)			Remark
1	Patch	I-PEX	Ant. 1 (5150-5850MHz)		Ant. 2 (5150-5850MHz)	For Model: TEW-940APB0 and TEW-940APB02K use only
			13.35		13.42	
2	Dipole	RSMA	5150MHz	5550MHz	5850MHz	For Model: TEW-940APB0 use only
			5.12	5.09	5.17	
3	Patch	I-PEX	Ant. 1 (5150-5925MHz)		Ant. 2 (5150-5925MHz)	For Model: TEW-940APB0 and TEW-940APB02K use only
			15.5		15.5	

Certifications

This device complies with Part 15 of the FCC Rules. Operation is subject to the following two conditions:
(1) This device may not cause harmful interference.
(2) This device must accept any interference received. Including interference that may cause undesired operation.



Waste electrical and electronic products must not be disposed of with household waste. Please recycle where facilities exist. Check with your Local Authority or Retailer for recycling advice.

Technical Support

If you have any questions regarding the product installation, please contact our Technical Support. Toll free US/Canada: **1-855-373-4741**
Regional phone numbers available at www.trendnet.com/support

TRENDnet

20675 Manhattan Place
Torrance, CA 90501
USA

Applies to PoE Products Only: This product is to be connected only to PoE networks without routing to the outside plant.

Note

The Manufacturer is not responsible for any radio or TV interference caused by unauthorized modifications to this equipment. Such modifications could void the user's authority to operate the equipment.

Advertencia

En todos nuestros equipos se mencionan claramente las características del adaptador de alimentación necesario para su funcionamiento. El uso de un adaptador distinto al mencionado puede producir daños físicos y/o daños al equipo conectado. El adaptador de alimentación debe operar con voltaje y frecuencia de la energía eléctrica domiciliar existente en el país o zona de instalación.

Product Warranty Registration

Please take a moment to register your product online. Go to TRENDnet's website at: www.trendnet.com/register