

User's Guide

TRENDNET[®]



**AX1800 Dual Band WiFi 6 PoE+
Access Point**

TEW-921DAP

Table of Contents

Product Overview	1	Auto Configuration (SLAAC/DHCPv6)	20
Package Contents	1	Change your IP address	20
Features	1	Captive Portal	21
Product Hardware Features.....	3	Captive Portal with RADIUS (CoovaChilli)	22
Application Diagram	4	Internal Captive Portal.....	23
Getting Started	5	Redirect URL	26
Steps to improve wireless connectivity	6	Create schedules	27
Connect wireless devices to your access point.....	6	Configure Spanning Tree	27
Configuration	7	Set date and time	28
Wireless Networking and Security	8	Daylight Saving Time	28
How to choose the type of security for your wireless network	8	NTP	28
Secure your wireless network	9	Manual.....	28
Connect wireless devices using WPS	12	Management VLAN.....	29
Advanced configuration	13	Wireless Bandwidth Control.....	29
Access the management page	13	Enable SNMP	29
Operating Modes	14	SSH Management	30
Access Point.....	15	LED Controls	31
Basic.....	15	Client Bridge	31
Wireless Profile.....	16	Basic.....	31
Wireless MAC filter	17	Scan for wireless networks.....	33
Band Steering.....	17	WDS	34
Airtime Fairness.....	18	WDS Link.....	34
Roaming Support (802.11k).....	18	Repeater.....	35
RSSI Scanner	19	Basic.....	35
IPv6 Settings	19	Scan for wireless networks.....	36
Static IPv6	20	Advanced wireless settings	37
		Advanced Wireless	37
		HT Physical Mode	38

Client Limit 38

Maintenance & Monitoring38

Administration 38

Device Name 39

Reset to factory defaults 39

Backup and restore your configuration settings 39

Restart (Reboot) access point..... 40

Upgrade your firmware 40

Configure log..... 41

Diagnostics..... 41

System information 42

Check connected wireless clients 43

System Log..... 44

IPv6 Status 44

Technical Specifications.....45

Troubleshooting.....48

Appendix49

Product Overview



TEW-921DAP

Package Contents

In addition to your access point, the package includes:

- TEW-921DAP
- 5 ft. (1.5 m) network cable
- Quick Installation Guide
- Mounting plate and cable guard

If any package contents are missing or damaged, please contact the retail store, online retailer, or reseller/distributor from which the product was purchased.

Features

TRENDnet's high-performance AX1800 Dual Band WiFi 6 PoE+ Access Point, model TEW-921DAP, features two concurrent WiFi bands to maximize device networking speeds with the latest WiFi 6 technology. The two separate high-speed WiFi 6 bands provide speeds up to 1201Mbps on the 5GHz band, and 567Mbps on the 2.5GHz band. Faster speeds are possible on this WiFi 6 access point with 1024-QAM, OFDMA, and MU-MIMO technologies.

This WiFi 6 access point supports innovative networking technology that improves coverage, speed, and capacity. The increase of QAM to 1024-QAM allows data to flow through a much wider 'pipe' than previous WiFi technologies. With OFDMA (Orthogonal Frequency-Division Multiple Access), the number of clients that can be connected to this WiFi 6 access point increases. OFDMA efficiently manages traffic in congested areas by separating channel frequencies into different subcarriers. MU-MIMO technology processes multiple data streams simultaneously, increasing real-time WiFi performance on the WiFi 6 AP when multiple devices access the network.

The TEW-921DAP WiFi 6 access point features advanced access control, QoS, traffic management, band steering, and captive portal support. The low-profile housing design seamlessly blends into most environments, with a convenient wall / ceiling mounting plate included. For application flexibility, the TEW-921DAP supports Access Point (AP), Client Bridge, Wireless Distribution System Access Point (WDS AP), WDS Bridge, WDS Station, and Repeater modes.

Concurrent Dual Band

AX1800: concurrent 1201Mbps on 5GHz band + 576Mbps on 2.4GHz band

Power over Ethernet (PoE+)

Saves on installation time and costs with gigabit PoE+ support (with optional power port for non-PoE installations)

WiFi Operation Modes

Supports Access Point (AP), Client Bridge, Wireless Distribution System Access Point (WDS AP), WDS Bridge, WDS Station, and Repeater modes for each WiFi band independently

MU-MIMO & OFDMA Performance

MU-MIMO and OFDMA technologies increase coverage, speed, and capacity

Band Steering

Band steering alleviates network congestion by automatically directing wireless devices from the 2.4GHz band to the less congested 5GHz band

WiFi Traffic Shaping

Manage traffic allocation on the WiFi 6 access point per SSID for each band separately

WPA3 Encryption

This WiFi 6 access point supports wireless encryption of up to WPA3

Multiple SSIDs

Create up to 8 SSIDs per band (16 total)

Captive Portal

Create a customized web portal for your users to authenticate using unique login credentials

Airtime Fairness

Airtime fairness support on this WiFi 6 access point provides higher priority to faster WiFi clients without limiting slower WiFi clients

Gigabit PoE+ Port

One gigabit PoE+ input port to power and connect the WiFi 6 AP to the network, and one gigabit port to connect it to a nearby device

LED Control

LED controls reduce product visibility by disabling LED indicators

Low Profile

The wireless AX access point's low-profile housing design blends into most environments

Mounting Plate

Wall / Ceiling mounting plate for this WiFi 6 access point is included

*Maximum wireless signal rates are referenced from IEEE 802.11 theoretical specifications. Actual data throughput and coverage will vary depending on interference, network traffic, building materials and other conditions.

Product Hardware Features

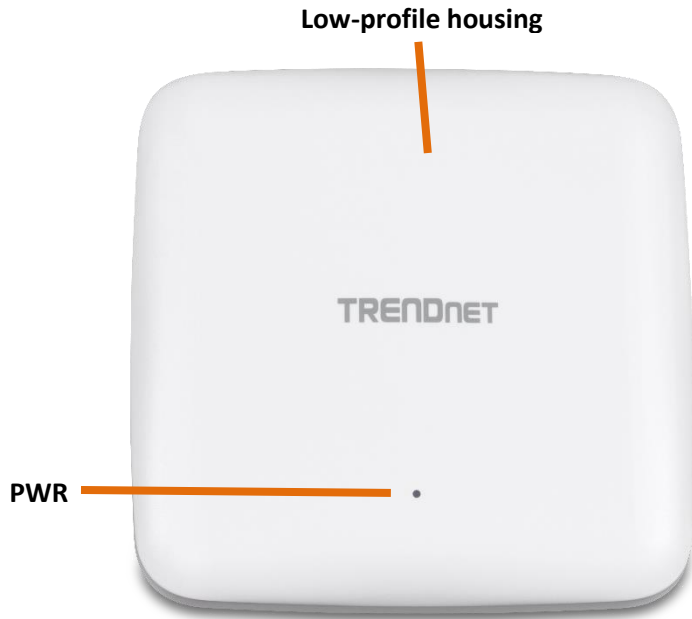

- **PWR:** This indicator turns green when the device is powered.



- **Gigabit PoE port:** Plug an Ethernet cable (also called network cables) from your access point to your router and wired network devices. The Gigabit port complies with standard 802.3af/at PoE/PoE+ so you can connect to connect the AP to a PoE switch or injector that complies with 802.3af/at.
- **Power port (optional):** If you are not using PoE to power the AP, you can connect the power adapter from your access point power port to an available power outlet.
- **Reset button:** Use a sharp tool to press and hold this button for 15 seconds to reset the access point.

AX1800 WiFi 6

Two concurrent high-speed WiFi 6 bands to maximize device networking speeds: 1201Mbps on 5GHz and 576Mbps on 2.4GHz.

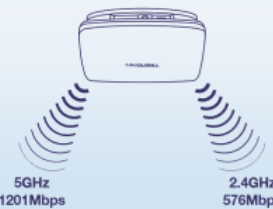

Built For Busy Environments

MU-MIMO and OFDMA technologies process multiple data streams simultaneously, increasing real-time WiFi performance when multiple devices access the network.

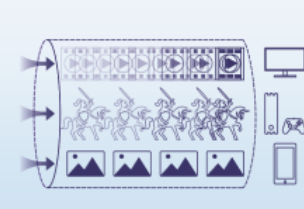

Access Point Flexibility

Supports Access Point, Client Bridge, WDS AP, WDS Bridge, WDS Station, and Repeater modes for multiple applications.

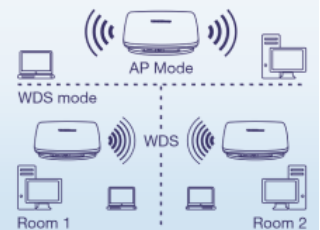

Application Diagram

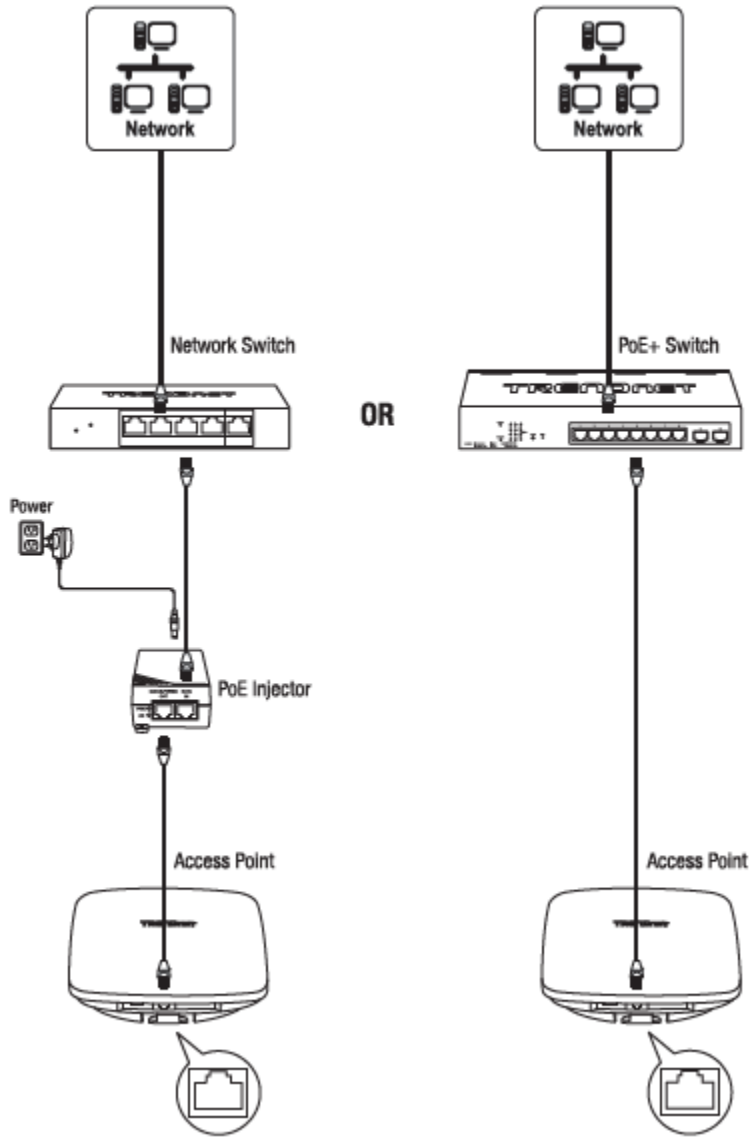

Getting Started

For a typical wireless setup at home or office when using the access point in AP mode, please do the following:

Installation

1. Plug an Ethernet cable on the access point to a PoE (Power over Ethernet) switch/injector that connects to your router or network.
2. Verify that the LED is on.
4. For your security, each TEW-921DAP comes pre-encrypted with a unique WiFi Name (SSID) and WiFi Password. You can find your device's SSID and WiFi password on the white labels located on the device. Use this information to connect to the TEW-921DAP access point.

Preset Wireless Settings	
Wi-Fi Name/SSID	
(AX/AC/N)	TRENDnet921_5GHz_XXXX
(AX/N/B/G)	TRENDnet921_2.4GHz_XXXX
Wi-Fi Password	
XXXXXXXXXX	
Management Login	
http://tew-921dap	
username:	admin
password:	XXXXXX

5. Verify your connection to you network by accessing the Internet. For advanced configuration continue to the advanced sections of the user manual.

Mounting device

To mount the access point, first route the network cable through the largest opening in the mounting plate and install the mounting plate to the desired wall or ceiling using the included drywall anchors and screws. Install the mounting plate with the correct orientation. After the mounting plate is properly installed, connect the network cable to the network LAN port of the access point, align the access point mounting holes with the mounting plate clips and rotate the access point clockwise to lock into place. Finally, install the cable guard by sliding it onto the mounting plate until it locks into place.

Ceiling mounting

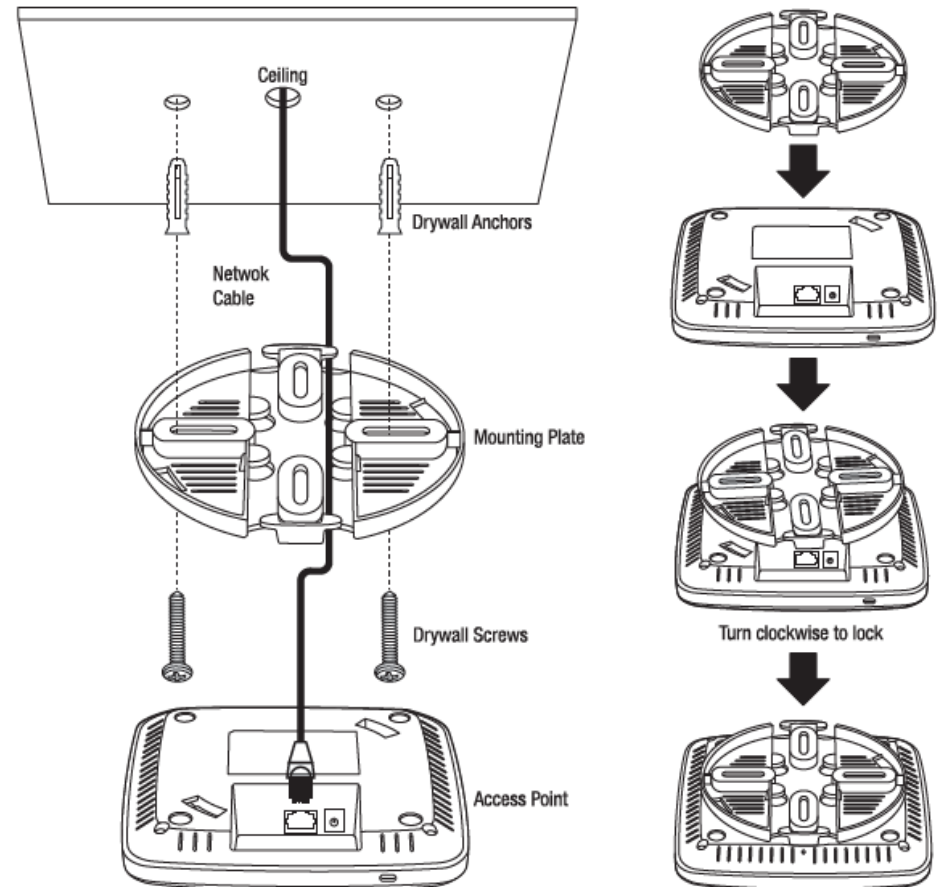

Steps to improve wireless connectivity

There are a number of factors that can impact the range of wireless devices. Follow these tips to help improve your wireless connectivity:

1. Keep the number of obstructions to a minimum. Each obstruction can reduce the range of a wireless device. Position the wireless devices in a manner that will minimize the amount of obstructions between them.
 - a. For the widest coverage area, install your router near the center of your home, and near the ceiling, if possible.
 - b. Avoid placing the access point on or near metal objects (such as file cabinets and metal furniture), reflective surfaces (such as glass or mirrors), and masonry walls.
 - c. Any obstruction can weaken the wireless signal (even non-metallic objects), so the fewer obstructions between the router and the wireless device, the better.
 - d. Place the access point in a location away from other electronics, motors, and fluorescent lighting.
 - e. Many environmental variables can affect the router's performance, so if your wireless signal is weak, place the access point in several locations and test the signal strength to determine the ideal position.
2. Building materials can have a large impact on your wireless signal. In an indoor environment, try to position the wireless devices so that the signal passes through less dense material such as dry wall. Dense materials like metal, solid wood, glass or even furniture may block or degrade the signal.
3. Antenna orientation can also have a large impact on your wireless signal. Use the wireless adapter's site survey tool to determine the best antenna orientation for your wireless devices.
4. Interference from devices that produce RF (radio frequency) noise can also impact your signal. Position your wireless devices away from anything that generates RF noise, such as microwaves, radios and baby monitors.

If possible, upgrade wireless network interfaces (such as wireless cards in computers) from older wireless standards to 802.11n. If a wirelessly networked device uses an older standard, the performance of the entire wireless network may be slower. If you are still experiencing low or no signal, consider repositioning the wireless devices or installing additional access points.

Connect wireless devices to your access point

A variety of wireless network devices can connect to your wireless network such as:

- Gaming Consoles
- Internet enabled TVs
- Network media players
- Smart Phones & Tablets
- Wireless Laptop computers
- Wireless IP cameras

Each device may have its own software utility for searching and connecting to available wireless networks, therefore, you must refer to the User's Manual/Guide of your wireless client device to determine how to search and connect to this router's wireless network.

See the "[Appendix](#)" on page 63 for general information on connecting to a wireless network.

Configuration

Note: The access point's default management page <http://192.168.10.100> is accessed through the use of your Internet web browser (e.g. Internet Explorer, Firefox, Chrome, Safari, and Opera) and will be referenced frequently in this User's Guide.

Before accessing the web-based management page, configure the IP address and subnet mask of your computer to the following:

IP Address: 192.168.10.xxx

Subnet Mask: 255.255.255.0

1. Open your web browser (e.g. Internet Explorer, Firefox, Safari, Chrome, or Opera) and go to <http://tew-921dap> or type in <http://192.168.10.100>.



2. Enter the default user name and password and then click **Login**. You can find your device's SSID and WiFi password on the white labels located on the device. Use this information to connect to the TEW-821DAP access point.

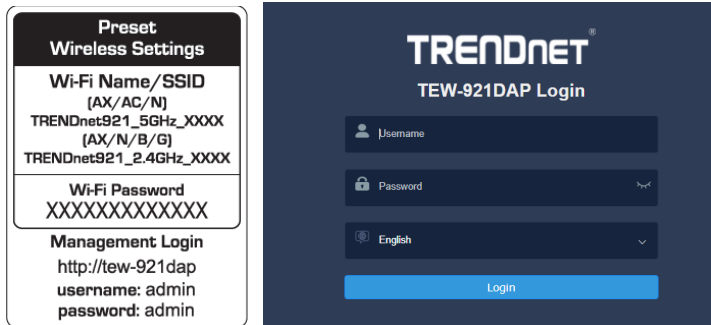

Wizard

1. For the first-time logging into the device the setup wizard will start automatically.

2. For your security, the first step is to change the login password of the access point. Enter your new login password and click OK.



3. Your new password settings will be applied and you will be redirected to the login screen. You will need to use the new login password to proceed.



Wireless Networking and Security

How to choose the type of security for your wireless network

Setting up wireless security is very important. Leaving your wireless network open and unsecured could expose your entire network and personal files to outsiders. TRENDnet recommends reading through this entire section and setting up wireless security on your new access point.

There are a few different wireless security types supported in wireless networking each having its own characteristics which may be more suitable for your wireless network taking into consideration compatibility, performance, as well as the security strength along with using older wireless networking hardware (also called legacy hardware). It is strongly recommended to enable wireless security to prevent unwanted users from accessing your network and network resources (personal documents, media, etc.). In general, it is recommended that you choose the security type with the highest strength and performance supported by the wireless computers and devices in your network. Please review the security types to determine which one you should use for your network.

Wireless Encryption Types

- **WEP:** Legacy encryption method supported by older 802.11b/g hardware. This is the oldest and least secure type of wireless encryption. It is generally not recommended to use this encryption standard, however if you have old 802.11 b or 802.11g wireless adapters or computers with old embedded wireless cards (wireless clients), you may have to set your router to WEP to allow the old adapters to connect to the router.
Note: This encryption standard will limit connection speeds to 54Mbps.
- **WPA:** This encryption is significantly more robust than the WEP technology. Much of the older 802.11g hardware was upgraded (with firmware/driver upgrades) to support this encryption standard. Total wireless speeds under this encryption type however are limited to 54Mbps.
- **WPA-Auto:** This setting provides the router with the ability to detect wireless devices using either WPA or WPA2 encryption. Your wireless network will automatically change the encryption setting based on the first wireless device connected. For example, if the first wireless client that connects to your wireless network uses WPA encryption your wireless network will use WPA encryption. Only when all wireless clients disconnect to the network and a wireless client with WPA2 encryption connects your wireless network will then change to WPA2 encryption.

Note: WPA2 encryption supports 802.11n speeds and WPA encryption will limit your connection speeds to 54Mbps

- **WPA2:** This is wireless encryption is similar to WPA encryption but more robust. This encryption standard also supports the higher connection speed.
- **WPA3:** This is the latest wireless encryption. It is similar to WPA2 encryption, but more robust. This encryption standard also supports the highest possible connection speed. TRENDnet recommends setting your router to this encryption standard. If you find that one of your wireless network devices does not support WPA3 encryption, then set your router to either WPA2 or WPA encryption.

Note: Check the specifications of your wireless network adapters and wireless appliances to verify the highest level of encryption supported. Below is brief comparison chart of the wireless security types and the recommended configuration depending on which type you choose for your wireless network.

Security Standard	WPA	WPA2	WPA3
Compatible Wireless Standards	IEEE 802.11a/b/g (802.11n devices will operate at 802.11g to connect using this standard)	IEEE 802.11a/b/g/n	IEEE 802.11 n/ac/ax
Highest Performance Under This Setting	Up to 54Mbps	Up to 450Mbps (11n) and up to 1.3Gbps (11ac)*	Up to 600Mbps (11n) and up to 1.2Gbps (11ax)*
Encryption Strength	Medium	High	Highest
Additional Options	TKIP or AES, Preshared Key or RADIUS	TKIP or AES, Preshared Key or RADIUS	AES
Recommended Configuration	TKIP Preshared Key 8-63 characters	AES Preshared Key 8-63 characters	AES Preshared Key 8-63 characters

*Dependent on the maximum 802.11n/ac/ax data rate supported by the device (150Mbps, 300Mbps, 450Mbps, 867Mbps, or 1.3Gbps)

Secure your wireless network

Wireless (2.4GHz or 5GHz) > Security

After you have determined which security type to use for your wireless network (see [“How to choose the security type for your wireless network”](#) on page 12), you can set up wireless security.

1. Log into your management page (see [“Access the management page”](#) on page 13).
2. Click on the Wireless 2.4GHz or 5GHz.

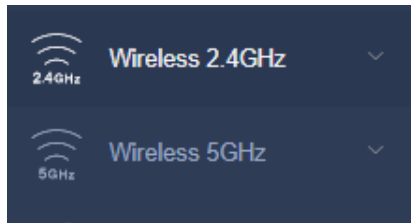

3. Underneath the basic wireless band section, you will see **Wireless Network** and all your wireless network profiles will be listed.
4. Click on the Edit button next to the wireless profile you want to configure.

Current Profiles					
Index	Status	SSID	Security Mode	Password	Edit
1	Enabled	SSID2G_DA1E	WPA2-PSK/AES	*****	Edit

5. Select from the drop-down list to the wireless security to configure.

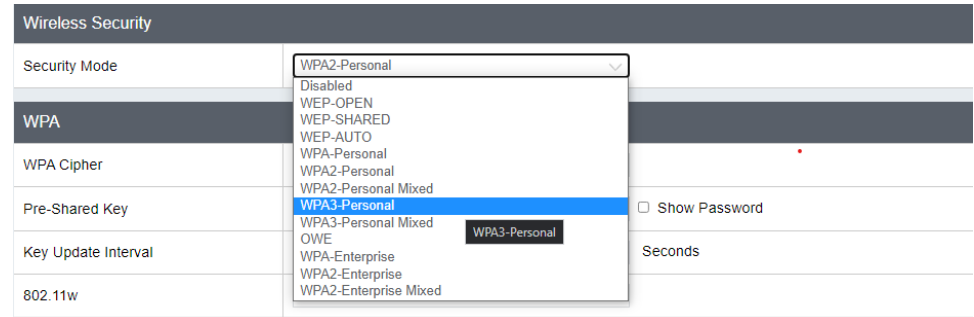

6. Review the wireless security settings, click Apply then the save button on the top-right when finished.

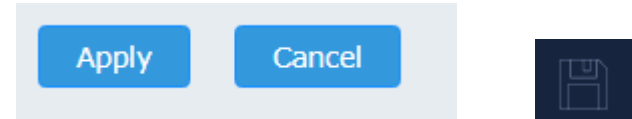

Selecting WEP-OPEN, WEP-SHARED: If selecting **WEP** (Wired Equivalent Privacy), please review the WEP settings to configure and click **Save** to save the changes.

Note: WPS functionality is not available when using WEP.

In the **Security Mode** drop-down list, select **WEP-OPEN** or **WEP-SHARED**.

Note: It is recommended to use WEP-OPEN because it is known to be more secure than Shared Key.

WEP			
Default Key			Key1
WEP Key 1	<input type="text"/>	<input type="checkbox"/> Show Password	HEX
WEP Key 2	<input type="text"/>	<input type="checkbox"/> Show Password	HEX
WEP Key 3	<input type="text"/>	<input type="checkbox"/> Show Password	HEX
WEP Key 4	<input type="text"/>	<input type="checkbox"/> Show Password	HEX

- **Default Key:** Select the WEP Key from the drop-down list to use
- **Network Key 1-4**
 - This is where you enter the WEP key needed for a computer to connect to the router wirelessly
 - You can define up to 4 passwords or 4 keys. Only one key can be active at a given time. Most users simply define one key.
 - Choose a key index 1, 2, 3, or 4 and enter the key.
 - When connecting to the access point, the client must match both the password and the Key number. (e.g. if you have activated Key 2 with a password of 12345, then the client must select: Key 2 (entering Key 1, 3, or 4 will block the ability to connect) and enter password 12345)

Note: It is recommended to use 128-bit format because it is more secure to use a key that consists of more characters.
- **HEX or ASCII:** Select which WEP code type to assign

Selecting WPA- Personal, WPA2- Personal or Mixed, WPA3-Personal or Mixed (WPA3-PSK recommended): In the **Security Mode** drop-down list, select **WPA- Personal**

WPA	
WPA Cipher	AES
Pre-Shared Key <input type="checkbox"/> Show Password
Key Update Interval	3600 Seconds
802.11w	Enable

The following section outlines options when selecting **WPA-Personal, WPA2- Personal, WPA2- Personal Mixed (Pre-shared Key Protocol), WPA3-Personal, or WPA3-Personal Mixed,**

- **WPA Cipher:** Select a Cipher Type to use. When selecting **WPA-PSK** security, it is recommended to use **TKIP + AES.**
 - When selecting **WPA2- Personal Mixed** security, it is recommended to use **TKIP+AES.**
 - When selecting **WPA2- Personal, WPA3-Personal, or WPA3-Personal Mixed** security, it is recommended to use **AES.**
- **Pre-Shared Key:** Enter the passphrase or password

WEP Key Format	HEX	ASCII
Character set	0-9 & A-F, a-f only	Alphanumeric (a,b,C,?,*,/,1,2, etc.)
64-bit key length	10 characters	5 characters
128-bit key length	26 characters	13 characters

- This is the password or key that is used to connect your computer to this router wirelessly

Note: 8-63 alphanumeric characters (a,b,C,?,*,/,1,2, etc.)
- **Key Update Interval:** Enter the time interval (seconds) of when the network passphrase will rotate.

Note: It is recommended to use the default interval time. Your passphrase will not change; rotation of the key is part of the WPA protocol and designed to increase security.
- **802.11w:** Select **Disable, Enable, or Required** for 802.11w Protected Management Frames (PMF)

Selecting WPA-Enterprise, WPA2-Enterprise, or WPA2-Enterprise Mixed:

WPA	
WPA Cipher	AES
Key Update Interval	3600 Seconds
802.11w	Disabled
Radius Server	
IP Address	
Port	
Shared Secret	<input type="checkbox"/> Show Password

The following section outlines options when selecting **WPA-Enterprise, WPA2-Enterprise or WPA2-Enterprise Mixed** known as EAP (Extensible Authentication Protocol). Also known as called Remote Authentication Dial-In User Service or **RADIUS.**

Note: This security type requires an external RADIUS server, PSK only requires you to create a passphrase.

- **WPA Cipher:** Select a Cipher Type to use. When selecting **WPA-PSK** security, it is recommended to use **TKIP + AES**.
- **Key Update Interval:** Enter the time interval (seconds) of when the network passphrase will rotate.
Note: It is recommended to use the default interval time. Your passphrase will not change; rotation of the key is part of the WPA protocol and designed to increase security.
- **IP Address:** Enter the IP address of the RADIUS server. (e.g. 192.168.10.250)
- **Port:** Enter the port your RADIUS server is configured to use for RADIUS authentication.
Note: It is recommended to use port 1812 which is typical default RADIUS port.
- **Shared Secret:** Enter the shared secret used to authorize your router with your RADIUS server.

Connect wireless devices using WPS

WPS (Wi-Fi Protected Setup) is a feature that makes it easy to connect devices to your wireless network. If your wireless devices support WPS, you can use this feature to easily add wireless devices to your network.

Note: You will not be able to use WPS if you set the SSID Broadcast setting to Disabled or if you are using WEP security.

There are two methods the WPS feature can easily connect your wireless devices to your network.

- Push Button Configuration (PBC) method
 - WPS Software/Virtual Push Button - located in the management page
 - PIN (Personal Identification Number) Method - located in the management page
- Note:** Refer to your wireless device documentation for details on the operation of WPS.

For connecting additional WPS supported devices, repeat this process for each additional device.

PBC (Software/Virtual Push Button)

Wireless (2.4GHz or 5GHz) > WPS

In addition to the hardware push button located physically on your router, the router management page also has push button which is a software or virtual push button you can click to activate WPS on your router.

1. Log into your management page (see "[Access the management page](#)" on page 13).
2. Click on the Wireless network you want to configure button (Wireless 2.4GHz or 5GHz) and click **WPS**.

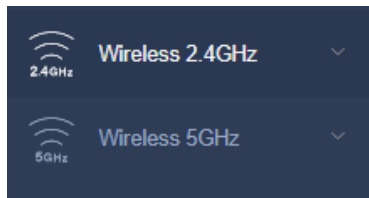

3. Click on **WPS** to configure the selected wireless band's WPS feature. Click **Apply** to save settings

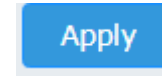

4. Review the WPS settings, click the **Save** button when finished.



WPS Config

WPS Config	
WPS	Enabled
WPS External Registrar Lock	Disabled

- **WPS:** Select enable to turn on WPS feature
- **WPS External Registrar Lock:** Select to enable or disable external registrar feature on the select wireless band.

WPS Summary

WPS Summary	
WPS Current Status	Idle
WPS Configured	Yes
WPS SSID	SSID2G_DA1E
WPS Security Mode	WPA2-Personal AES
WPS Key	1234567890
AP PIN	12345670

- **WPS Current Status:** Displays the status of WPS feature on the selected wireless band

- **WPS Configure:** Displays the configured mode of the WPS feature
- **WPS SSID:** Displays the SSID of the WPS network
- **WPS Security Mode:** Display the security mode of the WPS network
- **WPS Key:** Displays the security password
- **AP PIN:** Display the WPS PIN information.

WPS Action

WPS Action	
If you are using the Virtual Push Button method, click Start Push Button, then push and activate WPS on your wireless client device. If you are using the PIN method, enter the wireless client device PIN in the field and click Start PIN, then activate the WPS PIN method on your wireless client device.	
PIN	<input type="text"/> <input type="button" value="Start PIN"/>
PBC	<input type="button" value="Start Push Button"/>

- **PIN:** Enter the PIN information of the wireless client you want to connect to the network. Click Start PIN button to activate WPS once you enter the client's PIN information
Note: You may need to initiate the WPS PIN on your wireless device first when using this method. Refer to your wireless device documentation for details on the operation of WPS.
- **PBC:** Click **Start Push Button** to activate WPS PBC configuration.

Advanced configuration

Access the management page

Note: Your router management page URL/domain name <http://tew-821dap> or IP address <http://192.168.10.100> is accessed through the use of your Internet web browser (e.g. Internet Explorer, Firefox, Chrome, Safari, Opera) and will be referenced frequently in this User's Guide.

1. Open your web browser (e.g. Internet Explorer, Firefox, Safari, Chrome, or Opera) and go to URL/domain name <http://tew-921dap> or IP address <http://192.168.10.100>. Your router will prompt you for a user name and password.



2. You can find the **Password** on a sticker on the side of the router and on the label on the bottom of the router.

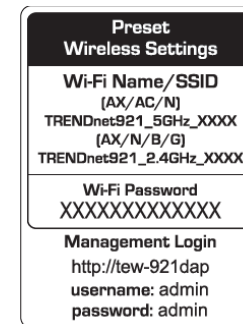

3. Enter your **Username** and **Password**, select your preferred language, and then click **Login**.

Operating Modes

This section outlines the available operating modes available on the access point.

1. Log into your management page (see "[Access the management page](#)" on page 13).
2. Click on **System** and **Operation Mode**.

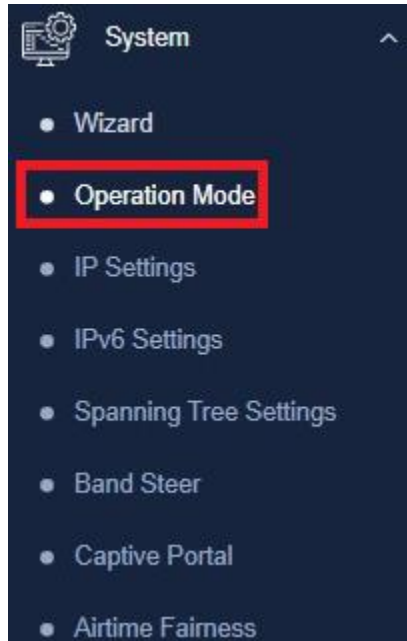

3. Select the operating mode from the drop down menu to apply on each wireless band.
4. Click on **Apply** button located on the bottom to save the settings, and click on the **Save** button located on the top left section to apply the saved settings.



Device Name: TEW-921DAP

2.4GHz Operation Mode

5GHz Operation Mode

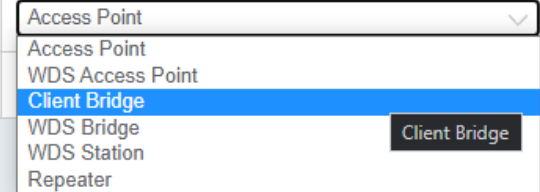

- **Access Point:** In this mode, the device creates a wireless network to your existing network.
- **Client Bridge:** Select this mode to allow the access point the ability to wireless connect to your wireless network. This is similar to a wireless laptop or mobile device connecting to a wireless network.
- **WDS Access Point:** In the mode, the access point connects to other WDS bridge enable devices for backbone communication and provides wireless connection to clients (STAs) at the same time.
- **WDS Bridge:** When this mode is selected the access point connects ONLY to other WDS bridge enabled devices and local networks (the other wireless interface and Ethernet interface) as a wireless backbone bridge.
- **WDS Station:** The wireless interface connects to other WDS bridge enabled devices for backbone communication and connects to other wireless access points at the same time. Use this mode to pair with the next hop access point as a WDS network outlet.
Note: Please note that only one bridge can be set up on 2.4GHz or 5.0GHz band, but not both.
- **Repeater:** In this mode, the wireless interface repeats wireless signal and packets for backbone communication as well as a client access. This feature is used to expand your existing wireless network to areas that your current access point is unable to reach. Make sure all of the settings of the wireless interface matches to your root or connecting wireless access points, same SSID, channel and wireless encryption settings.

Access Point



Apply



Basic

Wireless (2.4GHz or 5GHz) > Wireless Network

This section outlines the available features to configure for both wireless 2.4GHz and 5GHz when Access Point mode is selected.

1. Log into your management page (see [“Access the management page”](#) on page 13).
2. Click on the wireless band you would like to configure and click **Wireless Network**.

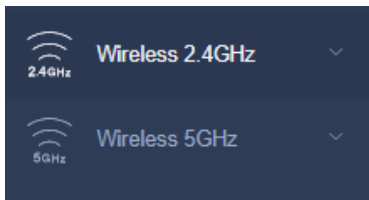

3. Configure the below settings and click **Save** to save settings.

Wireless Network	
Wireless Mode	2.4GHz 802.11 g/n/ax mixed mode
Channel Width	20 MHz
Extension Channel	Auto
Frequency (Channel)	Auto
AP Detection	Scan

4. Click on the **Save** button located on the top right section to apply settings.

- **Wireless Mode:** If all of the wireless devices you want to connect with this Access Point can connect in the same transmission mode, you can improve performance slightly by choosing the appropriate mode. If you have some devices that use a different transmission mode, choose the appropriate mode.

2.4GHz Wireless

- **2.4GHz B/G/N mixed:** Select this mode for the best compatibility. This mode allows older 802.11b and 802.11g wireless devices to connect to the access point in addition to newer 802.11n devices.
- **2.4GHz 802.11 g/n/ax mixed:** This mode allows devices to connect to the access point using the older and slower 802.11g, 802.11n or the newer and faster 802.11ax technology.
- **2.4GHz 802.11 g/n mixed:** This mode allows devices to connect to the access point using the older and slower 802.11g, or the newer 802.11n technology.
- **2.4GHz B/G mixed:** This mode only allows devices to connect to the access point using older and slow 802.11b or 802.11g technology and it thereby reduces the router's maximum speed to 54Mbps (typically not recommended).
- **G only:** This mode only allows devices to connect to the access point using older and slower 802.11g technology (typically not recommended).
- **B only:** This mode only allows devices to connect to the access point using older and slower 802.11b technology (typically not recommended).

Note: Please check the specifications on your wireless devices for the highest wireless capability supported first before applying these settings. If you are unsure, it is recommended that you keep the default setting (B/G/N mixed) for the best compatibility.

5GHz Wireless

- **A only:** This mode only allows devices to connect to the access point using older and slower 802.11a technology (typically not recommended).
- **A/N mixed:** This mode only allows devices to connect to the access point using older and slower 802.11a or 802.11n technology and it thereby reduces the access point's maximum speed to 54Mbps (typically not recommended).
- **N/AC mixed:** Select this mode for the best compatibility. This mode allows older 802.11a wireless devices to connect to the access point in addition to newer 802.11ac devices.

- **AC only:** This mode only allows devices to connect to the access point using newer and faster 802.11ac technology (typically not recommended).
- **A/N/AC mixed:** This mode allows older 802.11a and 802.11n wireless devices to connect to the access point in addition to newer 802.11ac devices.
- **A/N/AC/AX mixed:** This mode allows older 802.11a, 802.11n, 802.11ac wireless devices to connect to the access point in addition to the newer and faster 802.11ax.

Note: Please check the specifications on your wireless devices for the highest wireless capability supported first before applying these settings. If you are unsure, it is recommended that you keep the default setting (A/N/AC mixed) for the best compatibility.

When applying the 802.11 mode setting, please keep in mind the following:

- Wireless devices that support 802.11n are backwards compatible and can connect wirelessly at 802.11g or 802.11b.
- Connecting at 802.11b or 802.11g will limit the capability of your 802.11n supported wireless devices from obtaining higher performance and data rates.
- Allowing 802.11b or 802.11g devices to connect to an 802.11n capable wireless network may degrade the wireless network performance below the higher performance and data rates of 802.11n.
- Wireless devices that only support 802.11b or 802.11g will not be able to connect to a wireless network that is set to 802.11n only mode.
- Wireless devices that only support 802.11b will not be able to connect to a wireless network that is set to 802.11g only mode.
- **Channel Width:** Select the channel width for the access point to operate on. By default, the access point is on 20 MHz for the 2.4GHz and Auto 20/40/80 MHz for the 5GHz..
- **Extension channel:** When 20/40 channel bandwidth has been chosen, you should select extension channel to get higher throughput.
- **Frequency (Channel):** In North America, this access point can broadcast on 1 of 11 Channels for 2.4GHz (13 in Europe and other countries). Selecting the Auto option enables the router to automatically select the best Channel for wireless communication. To manually set the channel on which the router will broadcast, click the drop-down list and select the desired Channel for wireless communication. The goal is to select the Channel that is least used by neighboring wireless networks.

Wireless Profile

Wireless (2.4GHz or 5GHz) > Wireless Network

This section outlines the available features to configure for both wireless 2.4GHz and 5GHz when Access Point mode is selected.

1. Log into your management page (see "[Access the management page](#)" on page 13).
2. Click on the wireless band you would like to configure and click **Wireless Network**.

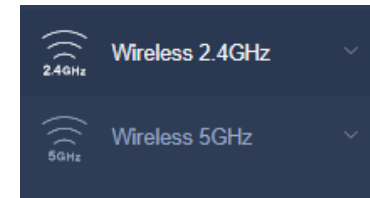

3. Underneath the basic wireless band section, you will see **Wireless Network** and all your wireless network profiles will be listed.
4. Click on the Edit button next to the wireless profile you want to configure.

Current Profiles					
Index	Status	SSID	Security Mode	Password	Edit
1	Enabled	TRENDnet921_2.4GHz_	WPA3-SAE AES	*****	Edit

5. Review the wireless settings, click **Save** and **Apply/Discard Changes** when finished.

Wireless Settings	
SSID	TRENDnet921_2.4GHz_C1B1
Status	Enabled
Hide SSID	Disabled
Separate Stations	Disabled
URL Tracking	Disabled

- **SSID:** Enter the wireless network name (SSID) to assign to the selected wireless profile
- **Status:** Select **Enable** to enable this SSID, or **Disable** to disable this SSID

- **Hide SSID:** Select option to disable the wireless network name to broadcast
- **Separate Stations:** Select this option to restrict wireless client devices from accessing other client devices connected to this network(s).
- **URL Tracking:** Enable this option to allow URL tracking on the selected SSID

Wireless MAC filter

Wireless (2.4GHz or 5GHz) > Wireless MAC Filter

Every network device has a unique, 12-digit MAC (Media Access Control) address. Using wireless MAC filters, you can allow or deny specific wireless clients using this access point's wireless network.

1. Log into your management page (see "[Access the management page](#)" on page 13).
2. Click on the wireless band you would like to configure and click **Wireless MAC Filter**.

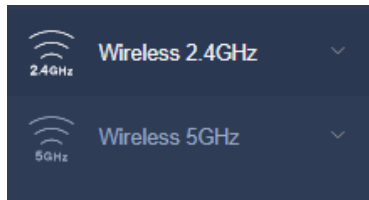

3. Review the settings and click **Save** and **Apply/Discard Changes** button to save settings.

Wireless MAC Filter	
Filter Mode	Disabled
MAC Address	<input type="text"/> (Ex: 00:11:22:33:44:55)

- **Filter Mode:** Select from the pull-down list the MAC filter rule to apply.
 - **Disable:** Select to turn off MAC filter feature
 - **DENY:** Select this option to DENY all listed MAC addressed
 - **ALLOW:** Select this option to only ALLOW the listed MAC address to the network.
- **MAC Address:** Enter the MAC address to apply on the MAC filter rule

MAC Filter List

MAC Filter List	
MAC	Delete
00:33:22:44:55:55	<input type="button" value="delete"/>

- **MAC:** List of all MAC addresses
- **Delete:** Click to remove the selected MAC address from the MAC Filter List

Band Steering

System > Band Steering

When both 2.4GHz and 5GHz bands are using the same SSID and WiFi security settings, this feature allows the AP to automatically detect if clients are 11AC capable and automatically pushing them over to the underutilized 5GHz bands. This allows your AP to use both bands more efficiently and making sure clients capable of the 11AC standard for faster speeds are establish WiFi links at 11AC connectivity whenever possible.

1. Log into your management page (see "[Access the management page](#)" on page 13).
2. Click on the **System** tab and click **Band Steer**.
3. Select enable from the drop down menu to turn on band steering feature and click **Apply** to save settings.

Band steering	
Status	Disabled

4. Click on **Save** button to save the settings and then click on the **Save** button located on the top left section to save the settings.

To enable band steering, you have to setup steering SSID the same in both 2.4GHz and 5GHz



Airtime Fairness

System > Airtime Fairness

This is an optional setting that will provide higher speed WiFi clients with higher traffic priority when competing for wireless bandwidth with slower speed clients. This can provide increased network performance by preventing higher speed clients from waiting for slower speed clients to completely data transfers before utilizing WiFi bandwidth.

Note: Airtime Fairness priority (highest to lowest): 802.11ac > 802.11n > 802.11a/g > 802.11b

1. Log into your management page (see "[Access the management page](#)" on page 13).
2. Click on the **System** tab and click on **Airtime Fairness**.
3. Select **Enable** from the drop down menu and click **Apply** to enable the airtime fairness feature.

Airtime Fairness

Status

Disabled

4. Click on the **Save** button located on the top right section to save the settings.



Roaming Support (802.11k)

Wireless (2.4GHz or 5GHz) > Wireless Network

The 802.11k standard is an enhancement to wireless roaming technology. It allows wireless access points to exchange and learn information about other access points on the network such as signal strength and client utilization and provide this information to 802.11k capable wireless client devices. Wireless client devices can use the information about other wireless network and make more intelligent decisions when roaming from one wireless access point to another. This also assists in better access point client utilization. **Note:** This function can only work with 802.11k capable wireless client devices. Please check your device specifications with your manufacturer for details.

1. Log into your management page (see "[Access the management page](#)" on page 13).
2. Click on **Wireless (2.4GHz or 5GHz)**, and click **Wireless Network**.

3. Under the Current Profiles section, click **Edit** for the profile you would like to configure.

Current Profiles					
Index	Status	SSID	Security Mode	Password	Edit
1	Enabled	TRENDnet921_2.4GHz_	WPA3-SAE AES	*****	Edit

4. Under the Roaming Assistant section, select **Enable** from the drop down menu under the **802.11k support** option to enable 802.11k support. The Scan Period defines how often the access point will scan for information about other access points on the wireless network.

Roaming Assistant	
802.11k Support	Disabled
Scan Period	10 Minutes

5. Click on **Apply** button to apply the settings and then click on the **Save** button located on the top right section to save the settings.



RSSI Scanner

System > Wireless (2.4GHz or 5GHz) > Wireless RSSI Scanner

The RSSI scanner feature allows the access point to scan for the signal strength of wireless client devices that currently connected and configured to automatically disconnect the wireless devices once signal strength and connectivity reach a specified limit. In a wireless roaming network with multiple access points, this can assist by forcing the disconnection of the wireless client device before signal strength and connectivity to the AP are too low to sustain enough bandwidth for Internet streaming applications. This will force the wireless client device to connect to an AP strong signal and connection rate relative to its new location. It is the nature of wireless client devices to maintain connectivity to the currently connected wireless network as long as the signal can still be discovered.

In the example diagram, you can see that the further away the client device is from the AP, the lower signal strength. (-30 RSSI is a higher strength value relative the AP compared to -90 RSSI). The client device at -90 RSSI is closer to the next AP but without the forced disconnection from the AP on the left using the RSSI scanner function, the client device would remain connected to the much further AP on the left than stronger signal AP on the right. Forcing a disconnect from the originally connected AP on the right would force the client to connect to the much higher signal strength AP on the right providing better connectivity during the transition between physical locations.

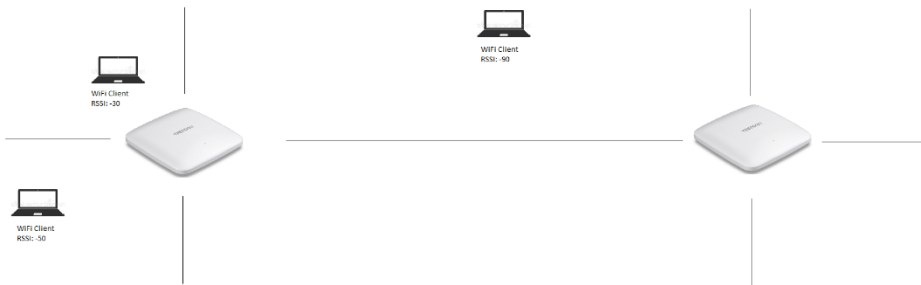

1. Log into your management page (see “[Access the management page](#)” on page 13).
2. Click on **Wireless (2.4GHz or 5GHz)**, and click **Wireless RSSI Scanner**.
3. Under the Current Profiles list, tick the SSID to enable the RSSI scanner feature.

- **RSSI Value:** First select the minimum RSSI value (client signal strength) before the AP disconnects the client (-30dBm is better signal strength than -90dBm).
- **Tolerance:** Then select the tolerance or action once the AP detects the specified signal strength of the client device is reached.
 - **Kick immediately** – This setting will immediately disconnect the client once the specified RSSI value is reached
 - **Detect # seconds** – Once the specified RSSI value is reached for a client device, this setting will check the client device signal strength again after the selected number of seconds. If the signal strength is still at the specified RSSI value or less, the client will be disconnected.

Current Profiles			
Status	SSID	Tolerance	RSSI value
Enabled	TRENDnet921_2.4GHz_C1B1	kick immediately	-90 dBm
Disabled		kick immediately	-90 dBm

5. Click on **Apply** button to apply the settings and then click on the **Save** button located on the top right section to save the settings.



IPv6 Settings

System > IPv6 Settings

1. Log into your management page (see “[Access the management page](#)” on page 13).
2. Click on the **System** tab and click **IPv6 Settings**.

IPv6 Connection Type

My IPv6 Connection is Local Connectivity Only

Note: Choose the mode to be used by the A

- Local Connectivity Only
- Static IPv6
- Autoconfiguration (SLAAC/DHCPv6)

3. Choose your IPv6 Connection Type.
4. When you are finished configuring the IPv6 Settings, click on **Apply** to save your changes and the **Save** button to apply the settings.

Static IPv6

Static IPv6 are static IP addresses that are usually provided by your Internet Service Provider (ISP).

1. Review the Static IPv6 settings below.

LAN IPv6 ADDRESS SETTINGS

LAN IPv6 Address	<input type="text"/>
Subnet Prefix Length	<input type="text" value="0"/>
Default Gateway	<input type="text"/>
Primary DNS Server	<input type="text"/>
Secondary DNS Server	<input type="text"/>

LAN IPv6 Address: Enter the IPv6 IP address provided to you by your Internet Service Provider (ISP)

Subnet Prefix Length: Enter the prefix length of your subnet mask

Default Gateway: Enter the default gateway of your Internet Service Provider (ISP)

Primary DNS Server / Secondary DNS Server: Enter the Primary and Secondary DNS server provided to you by your local Internet Service Provider (ISP)

Auto Configuration (SLAAC/DHCPv6)

1. Review the IPv6 DNS Settings below.

IPv6 DNS SETTINGS

DNS server access method	<input type="text" value="Use the following IPv6 DNS servers"/>
Primary DNS Server	<input type="text"/>
Secondary DNS Server	<input type="text"/>

2. Select either **Obtain IPv6 DNS server address automatically** or **Use the following IPv6 DNS Servers**.

- **Obtain IPv6 DNS server address automatically:** Selecting this option will allow the access point to automatically search for the DNS server address that is provided by your Internet Service Provider (ISP)
- **Use the following IPv6 DNS Servers:** Selecting this option enables you to manually input the Primary and Secondary DNS Servers

Change your IP address

System > IP Settings

In most cases, you do not need to change the IP address settings. Typically, the IP address settings only needs to be changed, if you plan to use another access point in your network with the same IP address settings, if you are connecting your access point to an existing network that is already using the IP address settings your access point is using.

Note: *If you are not encountering any issues or are not faced with one of the cases described above or similar, it is recommended to keep your router IP address settings as default.*

Default Access Point IP Address: 192.168.10.100 / 255.255.255.0

1. Log into your management page (see "[Access the management page](#)" on page 13).
2. Click on the **System** tab and click **IP Settings**.
3. Review the settings and click **Apply** to save changes.

LAN Connection Type	
Connection Type	STATIC

LAN Interface Setting	
IP Address	192.168.10.101
Subnet Mask	255.255.255.0
Default Gateway	192.168.10.254

DNS Server Setting	
Primary DNS Server	
Secondary DNS Server	

- **Connection Type:** Select on the pull-down menu the LAN connection type.
 - **DHCP:** Select this option to have the access point obtain an IP address from your DHCP server
 - **STATIC:** Select this option to manually assign and IP address to your access point
- **DNS Server:** Enter your network's DNS server IP address

4. Click on **Apply** button to apply the settings and then click on the **Save** button located on the top right section to save the settings.



URL Filtering

System > URL Filtering

The URL Filtering feature blocks connected clients from accessing selected websites.

1. Log into your management page (see "[Access the management page](#)" on page 13).
2. Click on the **System** tab and click **URL Filtering**

3. Select **Enabled** from the drop down menu.

URL Filtering	
URL Filtering	Enabled

Review the settings below and click **Apply** to save your settings.

Blocked URLs	1	Popular URL list	1/7
<input type="checkbox"/> www.youtube.com		<input type="checkbox"/> www.youtube.com	
		<input checked="" type="checkbox"/> www.twitter.com	
		<input type="checkbox"/> www.baidu.com	
		<input type="checkbox"/> www.news.google.com	
		<input type="checkbox"/> www.bilibili.com	
		<input type="checkbox"/> www.facebook.com	
		<input type="checkbox"/> www.yahoo.com	

[< Move](#)

www.google.com	Add	Delete
----------------	---------------------	------------------------

- **Blocked URLs:** Displays the list of URLs that are added to your **Blocked** lists.
- **Popular URL List:** Select from the preset of popular URLs to add to your blocked list.
 - **Move:** Move the selected URL to the block lists
- **Manually add:** Manually add websites in the empty field and click **Add** to add it to the block list.

4. Click on **Apply** button to apply the settings and then click on the **Save** button located on the top right section to save the settings.



Captive Portal

System > Captive Portal

The captive portal feature allows you to provide customized authentication typically for public WiFi users and guest user authentication. Captive Portal authentication for WiFi is typically used in areas such as hotel lobbies, airports, coffee shops and other WiFi hot spots. The access points supports both captive portal authentication through the built-in user account database and basic portal customization or CoovaChilli which is an open-source implementation of captive portal (UAM) function and 802.1X RADIUS (please note CoovaChilli requires an external CoovaChilli server which must be preconfigured to work and authenticate requests through the access point). You may want to disable standard WiFi security methods on the selected SSIDs such as WEP/WPA/WPA2 in order to use the captive portal authentication method instead. Before applying captive portal functionality to select wireless profiles, the captive portal type must be configured first along with all required parameters.

Select the captive portal mode:

- **Internal Captive Portal** – This mode allows you to authenticate requests through the built-in user account database and apply basic customization to the captive port user login page. This option is recommended and does not require an external authentication server.
- **Redirect URL** – This mode requires no authentication and allows redirection of users to a specific website/URL.
- **Captive Portal with RADIUS (CoovaChilli)** – This mode requires an external CoovaChilli server to be configured to provide the captive portal user login page and authenticate request through the access point.

Captive Portal with RADIUS (CoovaChilli)

Assuming your external CoovaChilli server has been installed and configured to authenticate requests through the access point.

1. Log into your management page (see "[Access the management page](#)" on page 13).
2. Click on the **System** tab and click **Captive Portal**.
3. Choose the Captive Portal mode **Captive Port with RADIUS**.

Mode

Select Mode

Captive Portal with Radius

4. Check the **Enable** option for the **Enable Captive Portal** setting to enable the captive portal feature. Tick which SSIDs to apply and require the captive portal authentication function.

2.4GHz SSID Support Captive Portal

- | | |
|--|--|
| <input type="checkbox"/> SSID #1 TRENDnet921_2.4GHz_C1B1 | <input type="checkbox"/> SSID #2 (off) |
| <input type="checkbox"/> SSID #3 (off) | <input type="checkbox"/> SSID #4 (off) |
| <input type="checkbox"/> SSID #5 (off) | <input type="checkbox"/> SSID #6 (off) |
| <input type="checkbox"/> SSID #7 (off) | <input type="checkbox"/> SSID #8 (off) |

5GHz SSID Support Captive Portal

- | | |
|--|--|
| <input type="checkbox"/> SSID #1 TRENDnet921-5GHz_C1B1 | <input type="checkbox"/> SSID #2 (off) |
| <input type="checkbox"/> SSID #3 (off) | <input type="checkbox"/> SSID #4 (off) |
| <input type="checkbox"/> SSID #5 (off) | <input type="checkbox"/> SSID #6 (off) |
| <input type="checkbox"/> SSID #7 (off) | <input type="checkbox"/> SSID #8 (off) |

5. Enter the CoovaChilli server settings.

- **Primary RADIUS Server** – Enter the IP address of the external CoovaChilli authentication server.
- **Secondary RADIUS Server** – If you have secondary or backup CoovaChilli authentication server, enter the IP address.
- **RADIUS Auth Port** – Enter the port number used by the Coovachilli server for authenticating RADIUS requests. The default port number used for RADIUS authentication is 1812.
- **RADIUS Acct Port** – Enter the port number used by the Coovachilli server for accounting on the server. The default port number for RAIDUS accounting is 1813.

- **RADIUS Shared Secret** – Enter the shared secret used to allow the CoovaChilli server to allow the access point to authentication RADIUS authentication requests.
- **RADIUS NAS ID**: Enter the NAS ID required by the CoovaChilli server to allow the access point to authentication RADIUS authentication requests.
- **UAM Portal URL** – Enter the UAM portal web URL address of the login authentication page provided by the CoovaChilli server.
- **UAM Secret** – Enter the UAM secret required to allow access to this portal page.

RADIUS Settings	
Primary RADIUS Server:	<input type="text"/>
Secondary RADIUS Server:	<input type="text"/>
RADIUS Auth Port:	<input type="text" value="1812"/>
RADIUS Acct Port:	<input type="text" value="1813"/>
RADIUS Shared Secret:	<input type="password" value="*****"/>
RADIUS NASID:	<input type="text" value="nas01"/>
UAM Setting	
UAM Portal URL:	<input type="text"/>
UAM Secret:	<input type="password" value="*****"/>

6. Click on **Apply** button to apply the settings and then click on the **Save** button located on the top right section to save the settings.



Internal Captive Portal

Note: The internal captive portal function works on HTTP web port 80. Once enabled, in order to log back in to the access point management page, when prompted for credentials

in the captive portal page, enter the access point administrator user name and password (default: admin / admin). After you have logged into the captive portal page with the access point administrative account, you will be redirected to the main access point management page for device configuration.

1. Log into your management page (see “[Access the management page](#)” on page 13).
2. Click on the **System** tab and click **Captive Portal**.
3. Choose the Captive Portal mode **Internal Captive Portal**.

Mode	
Select Mode	<input type="text" value="Internal Captive Portal"/>

First, enable Captive Portal, enter user name and password accounts for users to authenticate and set an authentication timeout value. Then click **Apply** at the bottom of the page to save the settings.

Captive Portal Settings	
Captive Portal	<input type="text" value="Disabled"/>
Login Method	<input type="text" value="User name and password"/>
Authentication Timeout	User name and password <input type="text" value="60"/> Minutes
	Single Password <input type="text" value="30"/> Minutes

Select the Login Method for connecting to your captive portal WiFi network. At the **Login Method** drop-down list, select one of the following.

- **User name and password** – Requires users to enter a user name and password for authentication to connect to your captive portal WiFi network which must be defined in the **Users List**.

Note: Multiple users can use the same user account to log into your captive portal WiFi network.

- To create a new user account, next to **Setting Username and Password**, enter the user name and password for the new user account and click **Add**. Repeat to add more user accounts.
- **Single password** – Requires users to enter a single password to connect your captive portal WiFi network which must be defined in the **Setting Single Password** settings.
 - To specify a single password, next to **Setting Single Password**, enter the new password or click **Generate** to randomly generate a new password.

Setting Single Password

abcde12345	Generate
------------	----------

- **Both** – Users can enter either a user name and password or single password to connect to your captive portal WiFi network. Both prompts will be displayed on the captive portal page and user can select either method to authenticate.
- Next, specify the **Authentication Timeout** settings. This is the session time period (minutes) which users are allowed to be logged in to your wireless network. Once the time expires, users will automatically be logged out and will need to log back in through the captive portal page again in order to reconnect to your wireless network. It is recommended to set a value to ensure authentication sessions are closed after a certain time period. Setting the value to 0 minutes allows users to be authenticated and connected to your captive portal WiFi network without any time restrictions.

Authentication Timeout	User name and password: <input type="text" value="60"/> Minute
	Single Password: <input type="text" value="30"/> Minute

Click **Save** when you have completed these settings.

- After your users authenticate and connect to your captive portal WiFi network, you may want to redirect your users to a specific URL, address, or website for advertisement purposes.

To enable this feature on your captive portal WiFi network, click the **Redirect** drop-down and select **Enable**. Enter the URL/address/website in the field **Redirect URL**. Click **Save** at the bottom of the page to save the settings.

Note: The prefix `http://` or `https://` must be included when entering URLs/addresses/websites (ex. <https://www.trendnet.com>)

Redirect	Enabled ▼
Redirect URL	<input type="text" value="https://www.trendnet.com"/>

After you have defined the initial parameters, you can apply portal page customization. Under Upload Image File, click **Browse** or **Choose File** depending on your browser, and navigate to the directory where the selected image is located and select the image. Once you have selected the image, click **Upload**.

Once you have uploaded the image, an image preview will appear and you can assign the image **Set as background** or **Set as logo**. If you would like to delete the image and upload a different image, you can also click **Delete** to delete the image.

Note: Only 2 images can be uploaded for portal page customization (Only one image can be set for the portal page background and another image can be set for the company/organization logo). Images are automatically scaled when uploaded. The recommended image formats are JPG, PNG, GIF. Maximum file size for images is 250KB.

Upload image files



Delete

Set as background.

Set as Logo.

Choose File No file chosen

Upload

After you have uploaded your images, you can add a welcome or greeting message to display to your guest users on the captive portal page. A preview of the page and text will also be displayed. After you have finished entering your message, click **Save** at the bottom of the page to save the settings.

Note: Aside from text, you can enter HTML tags for text formatting and styles.

Below is an example of a greeting message formatted in html.

```
<br><br><br>
```

```
<p style="color:white;font-family:verdana;text-align:center;">
```

```
Welcome to TRENDnet WiFi access!
```

```
Please enter your account information for Internet access. Happy surfing!
```

```
</p>
```

Message.(Support html syntax)

```
<br>Hello World!<br><br> Thank you for connecting to our complimentary guest WiFi
Internet access.<br><br> Please login with your credentials to start surfing the
internet. Have a nice day!
```

Preview area



Hello World!

Thank you for connecting to our
complimentary guest WiFi Internet access.

Please login with your credentials to start
surfing the internet. Have a nice day!

Additionally, you can modify the text displayed to your users for your terms of service. By default, a generic terms of service statement is provided for reference.

Terms of service

Terms of Service (TOS)

Access to WiFi.

The Service is a free public service. Your access to the Service may be blocked, suspended, or terminated at any time for any reason including, but not limited to, violation of this Agreement, disruption of access to other users or networks, or violation of applicable laws or regulations. You must accept this Agreement each time you use the Service and it is your responsibility to review it for any changes each time. This is an open wireless network.

To apply captive portal authentication to a wireless SSID, under 2.4G or 5G, select which SSIDs captive portal authentication should be applied, then click **Save** at the bottom of the page to save the settings.

Note: The SSIDs must be enabled and configured under Wireless > 2.4G or 5G to be assigned. If using Captive Portal authentication, it is recommended to set the Authentication method to None in the wireless SSID settings since captive portal authentication will be used instead. If the Authentication Method is left enabled, the users will need to authenticate twice, once with the authentication method defined and also captive portal authentication.

2.4GHz SSID Support Captive Portal

<input type="checkbox"/> SSID #1 TRENDnet921_2.4GHz_C1B1	<input type="checkbox"/> SSID #2 (off)
<input type="checkbox"/> SSID #3 (off)	<input type="checkbox"/> SSID #4 (off)
<input type="checkbox"/> SSID #5 (off)	<input type="checkbox"/> SSID #6 (off)
<input type="checkbox"/> SSID #7 (off)	<input type="checkbox"/> SSID #8 (off)

5GHz SSID Support Captive Portal

<input type="checkbox"/> SSID #1 TRENDnet921-5GHz_C1B1	<input type="checkbox"/> SSID #2 TRENDnet921_5g2
<input type="checkbox"/> SSID #3 (off)	<input type="checkbox"/> SSID #4 (off)
<input type="checkbox"/> SSID #5 (off)	<input type="checkbox"/> SSID #6 (off)
<input type="checkbox"/> SSID #7 (off)	<input type="checkbox"/> SSID #8 (off)

Click on **Apply** button to apply the settings and then click on the **Save** button located on the top right section to save the settings.

Apply



Redirect URL

1. Log into your management page (see "[Access the management page](#)" on page 13).
2. Click on the **System** tab and click **Captive Portal**.
3. Choose the Captive Portal mode **Redirect URL**.

Mode

Select Mode

Redirect URL

First, enable Captive Portal, enter the URL/website to redirect users and set an authentication timeout value. Then click **Save** at the bottom of the page to save the settings.

- **Redirect** – Enables the redirect URL captive portal function.
- **Redirect URL** – This is the website or URL guest users will be automatically redirected after connecting to your wireless network through your captive portal page. (e.g. <https://www.trendnet.com>)
- **Authentication Timeout** – This is the session time period (minutes) which users are allowed to be logged in to your wireless network. Once the time expires, users will automatically logged and will need to log back in through the captive portal page again in order to reconnect to your wireless network. It is recommended to set a value to ensure authentication sessions are closed after a certain time period.

Captive Portal Settings

Redirect	Enabled
Redirect URL	https://www.trendnet.com
Authentication Timeout	60 Minutes

Create schedules

System > Schedule

Create a schedule to define the days/time period when a feature should be active or inactive:

1. Log into your management page (see "[Access the management page](#)" on page 13).
2. Click on the **Management** tab and click **Schedule**.
3. Select from the pull-down menu under **Wireless Schedule** to **enable** wireless schedules and click **Apply** to save your settings.

Schedule Rule Status	
Wireless Schedule	<div style="border: 1px solid black; padding: 2px;"> Enabled ▼ Disabled Enabled </div>
<input type="button" value="Apply"/>	

3. Review the settings and click **Add** to save settings.

Add Schedule Rule	
Rule Name	<input type="text"/>
Service	Reboot ▼
Day(s)	Select Day(s) ▼ <input type="checkbox"/> Sun <input type="checkbox"/> Mon <input type="checkbox"/> Tue <input type="checkbox"/> Wed <input type="checkbox"/> Thu <input type="checkbox"/> Fri <input type="checkbox"/> Sat
Start Time	00 : 00 ▼
End Time	00 : 00 ▼

- **Rule Name:** Enter desired schedule name.
- **Service:** Allows you to set one of the actions either to Reboot the device, activate 2.4GHz or 5GHz or both bands.
- **Day:** Check the day(s) to implement the schedule.
- **Start Time:** Specify the time when this schedule will be in effect.

- **End Time:** Specify the time when this schedule will end.

4. After clicking **Add**, click on the **Save** button located on the top left section to save the settings.



Configure Spanning Tree

1. Log into your management page (see "[Access the management page](#)" on page 13).
2. Click on the **System** tab and click **Spanning Tree Settings**.
3. Review the settings and click **Save** to save changes.

Spanning Tree Settings	
Spanning Tree Status	Disabled ▼
Bridge Hello Time	2 Seconds (1-10)
Bridge Max Age	20 Seconds (6-40)
Bridge Forward Delay	4 Seconds (4-30)
Priority	32768 (0-65535)

- **Spanning Tree Status:** Select Enable or Disable to enable or disable spanning tree feature.
- **Bridge Hello Time:** Enter the bridge duration
- **Bridge Max Age:** Enter the max duration
- **Bridge Forward Delay:** Enter the delay duration
- **Priority:** Enter the priority

4. Click on **Apply** button to apply the settings and then click on the **Save** button located on the top right section to save the settings.

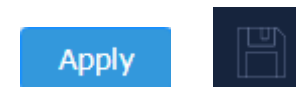

Set date and time

System > Time and Date Settings

There are two ways to set the access point's date and time. NTP (Network Time Protocol) is based on time servers. You can also manually set the router's date and time.

Note: It is important that the time is configured correctly before setting any schedules.

1. Log into your management page (see "[Access the management page](#)" on page 13).
2. Click on the **System** tab and click **Time and Date Settings**.
3. Next to **Time Zone**, click the drop-down list to select your time zone.

Time Configuration

System Time	Mon Nov, 15, 2021 22:49:09
Time Zone	United States-Los_Angeles

Daylight Saving Time

When using NTP or manual configuration, you may also configure Daylight Saving feature.

Daylight Saving Time

Enable Daylight Saving	Enabled
Daylight Saving Offset	+1:00
DST Start	Month Mar Week 3rd Day of Week Sun Hour 01
DST End	Month Nov Week 2nd Day of Week Sun Hour 01

- **Enable:** Select Enable or Disable
- **Daylight Saving Offset:** Select the offset amount for daylight savings to apply
- **DST Start/DST End:** Configure the start and end time of daylight savings.

NTP

1. Review the settings below and click **Save** to save settings.

NTP Settings	
Enable NTP Server	Enabled
NTP Server	Select NTP Server
NTP synchronization	300 (1~300) Minutes

- **Enable:** Select Enable or Disabled for NTP server settings
- **NTP Server:** Select the NTP server to use
- **NTP synchronization:** Enter the time of when the access point will continue to check for NTP updates.

2. Click on **Apply** button to apply the settings and then click on the **Save** button located on the top right section to save the settings.



Manual

1. Manually set the date and time of the access point by select the from the pull-down menus.

Date and Time Settings						
Date Settings	Year 2021	Month Nov	Day 15			
Time Settings	Hour 22	Minutes 56	Second 48			

2. Click on **Apply** button to apply the settings and then click on the **Save** button located on the top right section to save the settings.



Management VLAN

System > Management VLAN

1. Log into your management page (see "[Access the management page](#)" on page 13).
2. Click on the **System** tab and click **Management VLAN**.
3. Review the settings for both 2.4G and 5G profiles and click **Apply** to save settings.

2.4GHz Current Profiles			
Status	VID	SSID	WiFi Security
Disabled ▾		TRENDnet921_2.4GHz_C1B1	WPA3-SAE AES

5GHz Current Profiles			
Status	VID	SSID	WiFi Security
Disabled ▾		TRENDnet921-5GHz_C1B1	WPA2-PSK AES

- **Enable:** Select Enable to enable Management VLAN
- **VID:** Enter the VID to assign on the selected wireless network
- **SSID:** Displays the available SSID
- **WiFi Security:** Displays the wireless security type of the wireless network

Management VLAN Settings

Management VLAN ID Specified VLAN ID ▾ (must be in the range 2 ~ 4094.)

- **No VLAN Tag:** Select this option to use no VLAN Tag
 - **Specified VLAN ID:** Select this option and enter the assigned VLAN ID.
4. Click on **Apply** button to apply the settings and then click on the **Save** button located on the top right section to save the settings.

Apply



Wireless Bandwidth Control

Wireless (2.4GHz or 5GHz) > Wireless Bandwidth Control

1. Log into your management page (see "[Access the management page](#)" on page 13).
2. Click on the **Wireless (2.4GHz or 5GHz)** tab and click **Wireless Bandwidth Control**.
3. Review the settings for both wireless bands (2.4GHz and 5GHz) and click **Save** to save settings.

Wireless Bandwidth Control				
Bandwidth Control		Enabled ▾		
Current Profiles				
Status	SSID	Download MAX		Upload Limit for Client
Enabled ▾	TRENDnet921_2.4GHz_C1B1	Limit for Client ▾	10m	1m bps
Disabled ▾		Limit for Client ▾	10m	1m bps
Disabled ▾		Limit for Client ▾	10m	1m bps
Disabled ▾		Limit for Client ▾	10m	1m bps

- **Bandwidth Control:** Select **Enable** to enable bandwidth control on this SSID
- **SSID:** The SSID that the following limits will apply to
- **Download MAX:** Choose to set a limit per client or limit shared with entire SSID, then enter your network's inbound traffic limit
- **Upload Limit for Client:** Enter your network's outbound traffic limit for the selected wireless band

4. Click on **Apply** button to apply the settings and then click on the **Save** button located on the top right section to save the settings.

Apply



Enable SNMP

Management > SNMP Settings

SNMP (Simple Network Management Protocol) is a network management protocol used to monitor (read) and/or manage (write) multiple network devices on a network. This preconfigured external SNMP server.

1. Log into your management page (see "[Access the management page](#)" on page 13).

- Click on the **Management** tab and click **SNMP Settings**.
- Review the settings and click **Save** to save settings.

SNMP Settings	
SNMP	Enabled
Contact	
Location	
Community Name (Read Only)	public
Community Name (Read/Write)	private
Trap Destination Address	
Trap Destination Community Name	public
SNMPv3	Enabled
User Name	admin
Auth Protocol	MD5
Auth Key (8-32 Characters)	12345678
Priv Protocol	DES
Priv Key (8-32 Characters)	12345678
Engine ID	

- **SNMP:** Select enable to enable SNMP feature
- **Contact:** Enter the contact person or contact information for your access point.
- **Location:** Enter an assigned location for your access point.
- **Community Name (Read only):** Enter an assigned name for your access point.
- **Community (Read/Write):** Enter a public and private community name.
- **Trap Destination Address:** Enter the destination IP address of the SNMP trap.
- **Trap Destination Community Name:** Enter the name of the destination community

- **SNMPv3:** Select option to enable or disable SNMPv3
- **Username:** Enter the username
- **Auth Protocol:** Select from the pull down menu the authentication protocol to use
- **Auth Key:** Enter the authentication key
- **Priv Protocol:** Select the private protocol
- **Priv Key:** Enter the private key
- **Engine ID:** Enter the engine name

- Click on **Apply** button to apply the settings and then click on the **Save** button located on the top right section to save the settings.

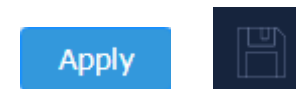

SSH Management

Management > SSH Management

SSH (Secure SHell) is a form of a CLI (Command Line Interface), a user interface where commands can be sent to the access point in the form of successive lines of text (command lines).

- Log into your management page (see "[Access the management page](#)" on page 16).
- Click on the **Management** tab and click **SSH Management**.
- Select **Enable** and click **Save** to save settings.

SSH Management	
SSH	Enabled

- Click on **Apply** button to apply the settings and then click on the **Save** button located on the top right section to save the settings.

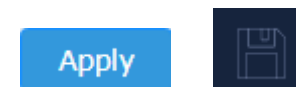

LED Controls

System > LED Control

1. Log into your management page (see "[Access the management page](#)" on page 13).
2. Click on the **System** tab and click **LED Control**.
3. Review the settings and click Save to save settings.



- **Power LED:** Select On to leave Power LED on or Off option to turn off.
4. Click on **Apply** button to apply the settings and then click on the **Save** button located on the top right section to save the settings.

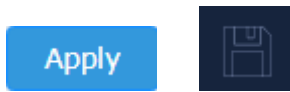

IGMP Snooping

System > IGMP Snooping

1. Log into your management page (see "[Access the management page](#)" on page 13).
2. Click on the **System** tab and click **LED Control**.
3. Review the settings and click **Apply** to save the settings.

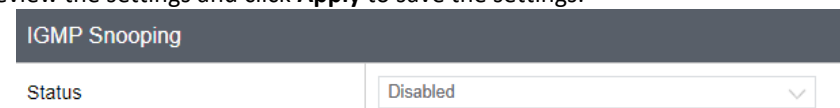

- **Status:** Select **Enable** to enable IGMP Multicast traffic

LLDP

System > LLDP

1. Log into your management page (see "[Access the management page](#)" on page 16).
2. Click on the **Management** tab and click **SSH Management**.
3. Select **Enable** to enable LLDP. Enabling LLDP allows network devices to advertise information about themselves to other devices on the network.
4. Click on **Apply** button to apply the settings and then click on the **Save** button located on the top right section to save the settings.

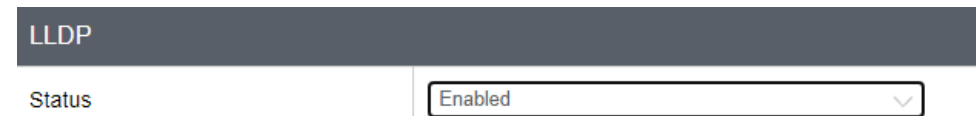
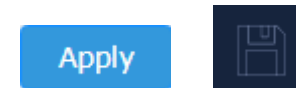

Client Bridge



Basic

Wireless (2.4GHz or 5GHz) > Wireless Network

This section outlines the available features to configure for both wireless 2.4GHz and 5GHz when Access Point mode is selected.

1. Log into your management page (see "[Access the management page](#)" on page 13).
2. Click on **System**, and select **Operation Mode**.

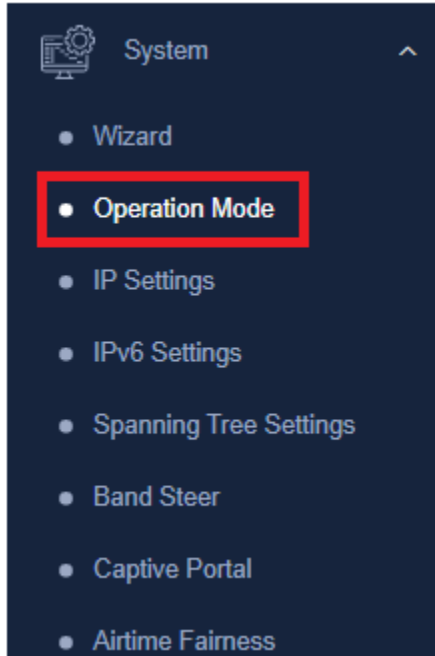

3. Enable **Client Bridge**, under the wireless band (2.4GHz or 5GHz) you would like to connect this access point to. Please make sure that the selected band is available on your network.

Device Name: TEW-921DAP	
2.4GHz Operation Mode	Client Bridge
5GHz Operation Mode	Access Point

4. Click **Apply** to save your current settings.
5. On the left-hand side menu, click on the wireless band tab (Wireless 2.4GHz / Wireless 5GHz) you would like to configure and click **Wireless Network**.

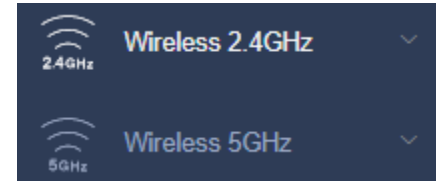

6. Configure the below settings and click **Save** and **Apply/Discard Changes** to save settings.

Wireless Network	
Wireless Mode	2.4GHz 802.11 g/n/ax mixed mode
SSID	AP SSID Site Survey
Preferred BSSID	Disabled

- **Wireless Mode:** Select the wireless mode to set on the selected wireless band in client bridge mode
- **SSID:** Manually enter the wireless network name (SSID) you want to establish connection. Or simply click on **Site Survey** to scan for available wireless network (more details below).
- **Preferred BSSID:** Click option and enter the preferred wireless network you would like to connect to.

Wireless Security	
Security Mode	Disabled

- **Security Mode:** Select from the pull-down menu the wireless security that is used on the wireless network you would like to connect to.

Scan for wireless networks

Wireless (2.4GHz or 5GHz) > Wireless Network

This section outlines the available features to configure for both wireless 2.4GHz and 5GHz when **Client Bridge** mode is selected.

1. Log into your management page (see "[Access the management page](#)" on page 13).
2. Click on the wireless band you would like to configure and click **Wireless Network**.

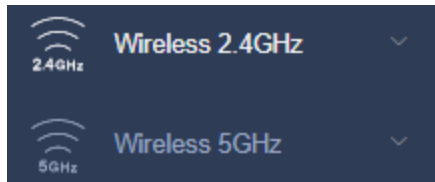

3. Under SSID section click **Site Survey** to wirelessly scan for available wireless networks.

Wireless Network

Wireless Mode	2.4GHz 802.11 g/n/ax mixed mode
SSID	AP SSID Site Survey
Preferred BSSID	Disabled

SSID	BSSID	Channel	Signal Level	Type	Security	Mode
ngHub_319436N001C05	28:C6:8E:CE:84:C2	11	-90 dbm	11NG HT20	WPA2-PSK AES	AP
TRENDnet714_2.4GHz_E4V8	6:04	1	-64 dbm	11NG HT20	WPA/WPA2-PSK AES	AP
TRENDnetSkyN	00:14:D1:DE:E3:C4	6	-55 dbm	11NG HT20	WPA2-PSK AES	AP
ATT54q7E16	38:A0:67:44:14:44	6	-86 dbm	11NG HT20	WPA2-PSK AES	AP
TRENDnetVICE	D8:EB:97:AE:58:05	1	-61 dbm	11NG HT20	WPA/WPA2-PSK TKIP/AES	AP

4. Click on the wireless network you would like to connect. The information will automatically fill on the previous screen. You will then need to select and enter the wireless security.

Wireless Security

Security Mode	WPA2-Personal
---------------	---------------

WPA

WPA Cipher	AES
Pre-Shared Key	<input style="border: 2px solid red;" type="text" value="word"/>

5. Click on **Apply** button to apply the settings and then click on the **Save** button located on the top right section to save the settings.



WDS

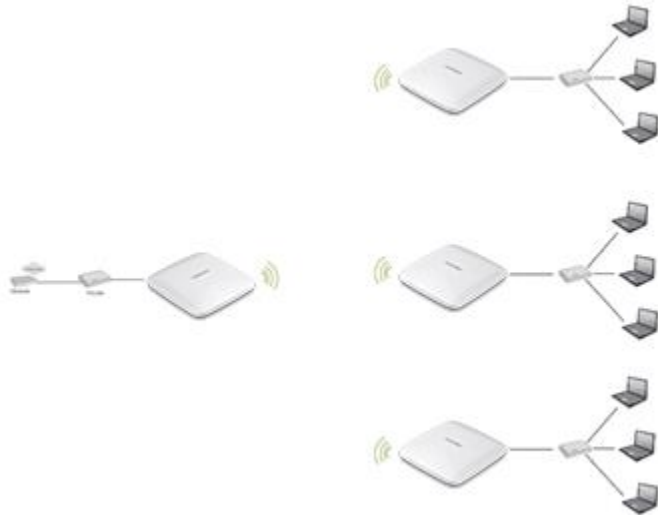

WDS Link

Wireless (2.4GHz or 5GHz) > WDS Link Settings

This section outlines the available features to configure for both wireless 2.4GHz and 5GHz when WDS mode is selected.

1. Log into your management page (see "[Access the management page](#)" on page 13).
2. Click on **System**, and select **Operation Mode**.
3. Enable **WDS Access Point**, under the wireless band (2.4GHz or 5GHz) you would like to connect this access point to. Please make sure that the selected band is available on your network.

Device Name: TEW-921DAP

2.4GHz Operation Mode	WDS Bridge
5GHz Operation Mode	Access Point

4. Click on the wireless band you would like to configure and click **WDS Link Settings**.

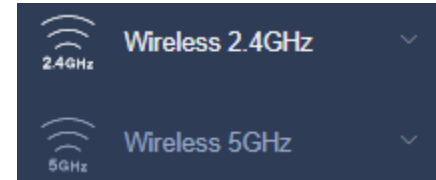

5. Configure the below settings and click **Save** to save settings.

Wireless Distribution System(WDS)

Local AP MAC Address	unavailable
Site Survey	Site Survey
Remote AP MAC Address	<input type="text"/>
Remote AP MAC Address	<input type="text"/>
Remote AP MAC Address	<input type="text"/>
Remote AP MAC Address	<input type="text"/>

- **Site Survey:** Click this option to scan for available WDS networks
- **Remote AP MAC:** Enter the MAC address of the remote access point you want to establish WDS connection.

Wireless Security

Security Mode	Disabled
---------------	----------

- **Security Mode:** Select from the pull-down menu the wireless security that is used on the wireless network you would like to connect to.

6. Click on **Apply** button to apply the settings and then click on the **Save** button located on the top right section to save the settings.



Repeater



Basic

Wireless (2.4GHz or 5GHz) > Wireless Network

This section outlines the available features to configure for both wireless 2.4GHz and 5GHz when Repeater mode is selected.

1. Log into your management page (see "[Access the management page](#)" on page 13).
2. Click on **System**, and select **Operation Mode**.



3. Enable **Repeater**, under the wireless band (2.4GHz or 5GHz) you would like to connect this access point to, then press **Save**. Please make sure that the selected band is available on your network.

Device Name: TEW-921DAP	
2.4GHz Operation Mode	Repeater
5GHz Operation Mode	Access Point

4. Click on the wireless band (Wireless 2.4GHz / Wireless 5GHz) you would like to configure and click **Wireless Network**.

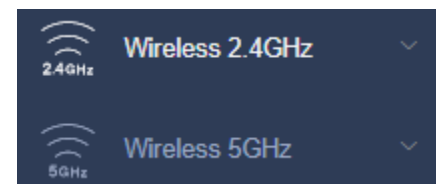

5. Configure the below settings and click **Save** to save settings.

Wireless Network	
Wireless Mode	2.4GHz 802.11 g/n/ax mixed mode
SSID	AP SSID Site Survey
Preferred BSSID	Disabled
Repeater SSID	

- **Wireless Mode:** Select the wireless mode to set on the selected wireless band in client bridge mode
- **SSID:** Manually enter the wireless network name (SSID) you want to establish connection. Or simply click on **Site Survey** to scan for available wireless network (more on this function in below section).
- **Preferred BSSID:** Click option and enter the MAC address of the preferred wireless network you would like to connect to.
- **Repeater SSID:** You may specify a new SSID name to use

Wireless Security

Security Mode	Disabled
---------------	----------

- **Security Mode:** Select from the pull-down menu the wireless security that is used on the wireless network you would like to connect to.

6. Click on **Apply** button to apply the settings and then click on the **Save** button located on the top right section to save the settings.

Apply



Scan for wireless networks

Wireless (2.4GHz or 5GHz) > Wireless Network

This section outlines the available features to configure for both wireless 2.4GHz and 5GHz when **Repeater** mode is selected.

1. Log into your management page (see "[Access the management page](#)" on page 16).
2. Click on the wireless band you would like to configure and click **Wireless Network**.

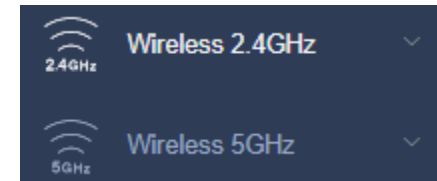

3. Under SSID section click Site Survey to wireless scan for available wireless networks.

Wireless Network	
Wireless Mode	2.4GHz 802.11 g/n/ax mixed mode
SSID	AP SSID Site Survey
Preferred BSSID	Disabled
Repeater SSID	

4. Click on the wireless network you would like to repeat. The information will automatically fill on the previous screen. You will then need to select and enter the wireless security.

SSID	BSSID	Channel	Signal Level	Type	Security	Mode
ngHub_319436N001C05	28:C6:8E:CE:84:C2	11	-90 dbm	11NG HT20	WPA2-PSK AES	AP
TRENDnet714_2.4GHz_E4V8	6:04	1	-64 dbm	11NG HT20	WPA/WPA2-PSK AES	AP
TRENDnetSkyN	00:14:D1:DE:E3:C4	6	-55 dbm	11NG HT20	WPA2-PSK AES	AP
ATT54q7E16	38:A0:67:44:14:44	6	-86 dbm	11NG HT20	WPA2-PSK AES	AP
TRENDnetVICE	D8:EB:97:AE:58:05	1	-61 dbm	11NG HT20	WPA/WPA2-PSK TKIP/AES	AP

5. Click on **Apply** button to apply the settings and then click on the **Save** button located on the top right section to save the settings.



Advanced wireless settings

Wireless (2.4GHz or 5GHz) > Advanced Wireless

1. Log into your management page (see "[Access the management page](#)" on page 13).
2. Click on the wireless band you would like to configure and click **Wireless Advanced Settings**.

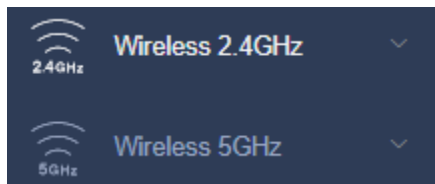

3. Review the settings and click **Save** to save settings.

Advanced Wireless

Advanced Wireless	
Data Rate	Auto
Transmit Power	Auto
RTS/CTS Threshold	2347 (range 1 - 2347, default 2347)
Beacon Period	100 ms (range 100 - 1000, default 100)
DTIM	1 (range 1 - 255, default 1)
ARP Proxy	Disabled
Wi-Fi Multimedia (WMM)	Enabled
WMM Powersave	Enabled
Broadcast/Multicast Rate Limiting	50 (range 1 - 55, default 50)

- **Data Rate:** Select the operating wireless data rate.
- **Transmit Power:** The wireless transmit power can be modified to lower the antenna strength setting from 25 dBm to 11 dBm, if necessary. Lowering the wireless transmit power may help to better stabilize the wireless connectivity and reduce the effects of wireless interference in areas where there are several 2.4GHz wireless devices. (Default: 18 dBm)
- **RTS/CTS Threshold:** The Request To Send (RTS) function is part of the networking protocol. A wireless device that needs to send data will send a RTS before sending the data in question. The destination wireless device will send a response called Clear to Send (CTS). The RTS Threshold defines the smallest data packet size allowed to initiate the RTS/CTS function. Default Value: 2347 (range: 256-2346)
- **Beacon Period:** A beacon is a management frame used in wireless networks that transmitted periodically to announce the presence and provide information about the access point's wireless network. The interval is the amount time between each beacon transmission.
- **DTIM:** DTIM is a countdown informing clients of the next window for listening to broadcast and multicast messages. When the access point has buffered broadcast or multicast messages for associated clients, it sends the next DTIM with a DTIM

Interval value. Wireless clients detect the beacons and awaken to receive the broadcast and multicast messages. The default value is 1. Valid settings are between 1 and 255.

- **ARP Proxy:** ARP Proxy lets helps clients communicate with other clients on other subnets. By default, it is set to Disable.
- **Wi-Fi Multimedia (WMM):**
- **WMM Powersave:** When enabled, clients connected to it can go to sleep mode when no data packets are being sent. The access point will automatically wake up the client when the data packet needs to be sent. By default, this is set to Disabled.
- **Broadcast/Multicast Rate Limiting:** Enable to set the rate limit used to protect the network from disruption from excessive broadcast or multicast traffic. By default, this is set to Disabled.

HT Physical Mode

HT Physical Mode	
Guard Interval	Auto
A-MPDU	Enabled
255 (Max)	Frames 64 KBytes

- **Guard Interval:** Select to set the guard interval.
- **A-MPDU:** MPDU aggregation also collects Ethernet frames to be transmitted to a single destination, but it wraps each frame in an 802.11n MAC header. Normally this is less efficient than MSDU aggregation, but it may be more efficient in environments to maintain performance in noisy networks and to prevent hidden nodes from degrading the performance.

Client Limit

Client Limit	
Client Limit	Enabled
Max Client	127

- **Client Limit:** Select enable to turn on client limit of the select wireless band
- **Max Client:** Enter the amount of clients to allow

4. Click on **Apply** button to apply the settings and then click on the **Save** button located on the top right section to save the settings.



Maintenance & Monitoring

Administration

Management > Administration

You may want to change your login credentials for logging into your access point. Resetting the access point to factory default settings will also reset the login credentials back to factor default which can be found on the label or on the back of the unit.

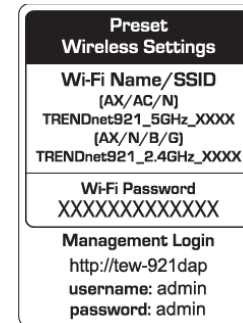

1. Log into your management page (see "[Access the management page](#)" on page 13).
2. Click on the **Management** tab and click **Administration**.
3. Review the settings and click **Save** to save settings.

Administrator Settings	
Account	admin
Password	(Max: 16 Characters)
Idle Timeout	3600 (120-3600 Seconds)

- **Account:** Change the login user name in this field
- **Password:** Change the login password in this field
- **Idle Timeout:** Change the length of time that the access point can idle before timing out. The duration can be between 120 – 3600 seconds. (By default it is set to 120 seconds)

Device Name

Management > Administration

1. Log into your management page (see “[Access the management page](#)” on page 13).
2. Click on the **Management** tab and click **Administration**.
3. In the **Device Name** field, change the name of the device (eg: room, office etc)

Device Name Settings	
Device Name	TEW-921DAP

4. Click on **Apply** button to apply the settings and then click on the **Save** button located on the top right section to save the settings.



Reset to factory defaults

Management > Backup/Restore Settings

You may want to reset the access point to factory defaults if you are encountering difficulties and have attempted all other troubleshooting. Before you reset to defaults, if possible, you should backup your access point's configuration first.

There are two methods that can be used to reset your access point to factory defaults.

- **Reset Button:** Located on the side of the access point, (see “[Product Hardware Features](#)” on page 5). Use this method if you are encountering difficulties with accessing your router management page.

OR

• Access Point Management Page

1. Log into your management page (see “[Access the management page](#)” on page 13).
2. Click on the **Management** tab and click **Backup/Restore Settings**.
3. Click **Load Default**. If prompted, click **Yes** or **Ok**.

Backup and restore your configuration settings

Management > Backup/Restore Settings

You may have added many customized settings to your router and in the case that you need to reset your router to default, all your customized settings would be lost and would require you to manually reconfigure all of your router settings instead of simply restoring from a backed up router configuration file.

To back up your configuration:

1. Log into your management page (see “[Access the management page](#)” on page 13).
2. Click on the **Management** tab and click **Backup/Restore Settings**.
3. Click **Export**.

4. Click on **Apply** button to apply the settings and then click on the **Save** button located on the top right section to save the settings.



5. Depending on your web browser settings, you may be prompted to save a file (specify the location) or the file may be downloaded automatically to the web browser settings default download folder. (Default Filename: *config.bin*)

6. Save the configuration file to location on your computer.

To restore your configuration:

1. Log into your management page (see "[Access the management page](#)" on page 13).
2. Click on the **Management** tab and click **Backup/Restore Settings**.
3. Under **Import Settings**, depending on your web browser, click on **Browse** or **Choose File**. A separate file navigation window should open.

Import Settings

Settings File Location

No file chosen

4. Navigate to the location of the access point configuration file to restore.
(Default Filename: *config.bin*).
5. Select the access point configuration file to restore. Enter the login password under Encrypt Key and click **Save**.
(Default Filename: *config.bin*). If prompted, click **Yes** or **OK**.
6. Wait for the access point to restore settings.

Restart (Reboot) access point

Management > Backup/Restore Settings

You may want to restart your access point if you are encountering difficulties with your access point and have attempted all other troubleshooting.

There are two methods that can be used to restart your access point.

- **Turn the router off** disconnect the power source or press the power button from the side of your access point (see "[Product Hardware Features](#)" on page 5).
 - Use this method if you are encountering difficulties with accessing your router management page. This is also known as a hard reboot or power cycle.
- OR
- **Router Management Page:** This is also known as a soft reboot or restart.

1. Log into your management page (see "[Access the management page](#)" on page 13).
2. Click on the **Management** tab and click **Backup/Restore Settings**.
3. Click **Reboot** under **System Reboot** to restart the access point. If prompted, click **yes** or **OK**.

System Reboot

System Reboot

Upgrade your firmware

Management > Upload Firmware

TRENDnet may periodically release firmware upgrades that may add features or fix problems associated with your TRENDnet access point model and version. To check if there is a firmware upgrade available for your device, please check your TRENDnet model and version using the link. <http://www.trendnet.com/downloads/>

In addition, it is also important to verify if the latest firmware version is newer than the one your access point is currently running. To identify the firmware that is currently loaded on your access point, log in to the router, click on the **Status** tab and select **Main**. If there is a newer version available, also review the release notes to check if there were any new features you may want or if any problems were fixed that you may have been experiencing.

1. If a firmware upgrade is available, download the firmware to your computer.
2. Unzip the file to a folder on your computer.

Please note the following:

- Do not interrupt the firmware upgrade process. Do not turn off the device or press the Reset button during the upgrade.
- If you are upgrade the firmware using a laptop computer, ensure that the laptop is connected to a power source or ensure that the battery is fully charged.
- Disable sleep mode on your computer as this may interrupt the firmware upgrade process.
- Do not upgrade the firmware using a wireless connection, only using a wired network connection.
- Any interruptions during the firmware upgrade process may permanently damage your router.

1. Log into your management page (see "[Access the management page](#)" on page 13).
2. Click on **Management**, and click on **Upload Firmware**.

- Depending on your web browser, next to **Upgrade Firmware**, click **Browse** or **Choose File**.

Firmware	
Location	<input type="button" value="Choose File"/> No file chosen

- Navigate to the folder on your computer where the unzipped firmware file (.bin) is located and select it.
- Click **Open** to start the firmware upgrade process. If prompted, click **yes** or **OK**.

Configure log

Management > Log

- Log into your management page (see "[Access the management page](#)" on page 13).
- Click on the **Management** tab and click **Log**. Click apply to save settings

System Log	
Enable System Log	<input type="text" value="Enabled"/>
Syslog Server IP Address	<input type="text" value="0.0.0.0"/>
Local Log	
Local Log	<input type="text" value="Enabled"/>

- **Enable System log:** Select option to enable system log feature
- **Syslog Server IP Address:** Enter the IP address of the syslog server
- **Local Log:** Select enable to enable local log feature

- Click on **Apply** button to apply the settings and then click on the **Save** button located on the top right section to save the settings.

Diagnostics

Management > Diagnostics

Ping Test

- Log into your management page (see "[Access the management page](#)" on page 13).
- Click on the **Management** tab and click **Diagnostics**.

Ping Test Parameter	
IP Address	<input type="text"/>
Packet Length	<input type="text" value="64"/> (bytes)
Number of Pings	<input type="text" value="4"/>

- **IP Address:** Enter the IP address you would like to conduct the ping test
- **Packet Length:** Enter the packet size
- **Number of Pings:** Enter the amount of pings to conduct.
- **Ping:** Click to start ping test

TraceRoute

- Log into your management page (see "[Access the management page](#)" on page 13).
- Click on the **Management** tab and click **Diagnostic**.

Traceroute Parameter	
Target	<input type="text"/>

- **Target:** Enter the IP address to conduct traceroute test
- **Traceroute:** Click to start traceroute test

Download Technical Support Data

- Log into your management page (see "[Access the management page](#)" on page 13).
- Click on the **Management** tab and click **Diagnostic**.

Download Technical Support Data	
Download Data	<input type="button" value="Download"/>

- Depending on your web browser settings, you may be prompted to save a file (specify the location) or the file may be downloaded automatically to the web browser settings default download folder. (Default Filename: *TRENDnet EAP_config.bin*)
- Save the configuration file to location on your computer.

****Technical Data may be requested from you by a technical support representative to further assist you with issues****

System information

Dashboard > Dashboard

- Log into your management page (see "[Access the management page](#)" on page 16).
- Click on the **Status** tab and click **Main**.
- Review the device information.

System

System Info

Device Name	TEW-921DAP
Firmware Version	2.00, 16, Nov, 2021
System Time	Tue Nov, 16, 2021 15:43:17
System Up Time	0 Day, 17:27:30

- Device Name:** Displays the assigned device name
- Firmware Version:** Displays the firmware version currently loaded on the router
- System Time:** Displays the current time of the device
- System Up Time:** Displays the time duration of how long the device has been running

Network

Network	
MAC Address	18:17:25:35:DA:1E
IP Address	192.168.10.101
Subnet Mask	255.255.255.0
Default Gateway	192.168.10.254
Primary Domain Name Server	-
Secondary Domain Name Server	-

- MAC Address:** Displays the device's MAC address
- IP Address:** Displays the assigned IP address
- Subnet Mask:** Displays the subnet mask of the device
- Default Gateway:** Displays the default gateway of the device
- Primary/Secondary DNS:** Displays the DNS IP address of the device

Usage

Most Used SSID	TRENDnet921-5GHz_C1B1
	<div style="display: flex; justify-content: space-between;"> ↓ 8.46 GB ↑ 22.84 MB </div>
Most Active Client	88:e9:fe:78:11:97
	<div style="display: flex; justify-content: space-between;"> ↓ 729.90 MB ↑ 6.39 MB </div>
All-time Top Client	a6:b5:de:99:b7:c4
	<div style="display: flex; justify-content: space-between;"> ↓ 473.48 MB ↑ 1.90 MB </div>

- Most Used SSID:** Displays the SSID with the highest total download and upload of data

- **Most Active Client:** Displays the client with the most utilization of data since the last refresh
- **All-time Top Client:** Displays the client with the most utilization of data since the access point last powered on

Wireless (Both 2.4GHz and 5 GHz)

2.4GHz Wireless			
Operation Mode	Access Point		
Wireless Mode	2.4GHz 802.11 g/n/ax mixed mode		
Channel Width	Auto 20/40 MHz		
Frequency (Channel)	CH11 - 2462MHz		
TX (Packets)	8.40MB (7092 PKts.)		
RX (Packets)	308.71KB (3075 PKts.)		
SSID List			
SSID	MAC Address	Security Mode	Status
TRENDnet921_2.4GHz_C1B1	18:17:25:35:DA:1F	WPA3-SAE AES	ON

- **Operation Mode:** Displays the current operating mode for each wireless band
- **Wireless Mode:** Displays the wireless mode set on each wireless band
- **Channel Width:** Displays the applied channel width
- **Frequency (Channel):** Displays the current operating wireless channel
- **Tx/Rx Packets:** Displays the Transmit (Tx) and Receive (Rx) packet rate
- **SSID List:** Displays the multiple SSID settings.

CPU & Memory Utilization

CPU & Memory Utilization

CPU	Used	3 %
	Idle	97 %
Memory	Total	375448 KB
	Free	102472 KB
	Used	272976 KB

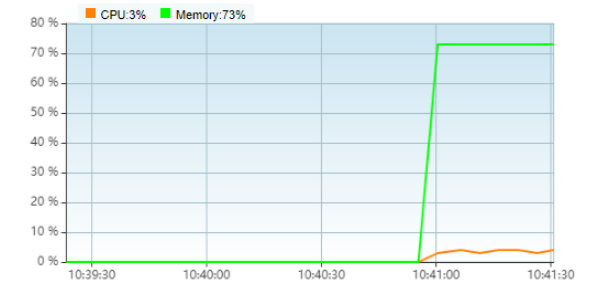

- **CPU:** Displays how much of the CPU's computing power is being used and how much of it is on standby
- **Memory:** Displays the total memory, how much memory is left and how much has been used

Total Clients

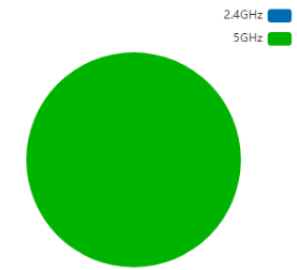

Total Throughput

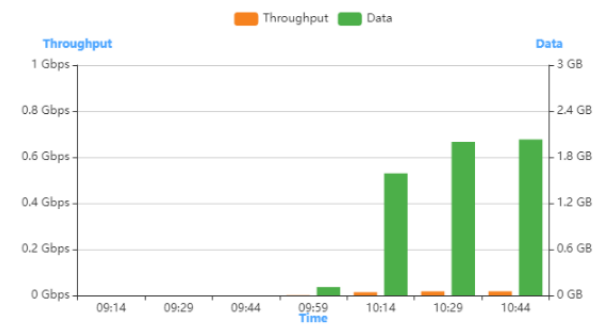

- **Total Clients:** Displays the total number of connected clients by each wireless band
- **Total Throughput:** Displays the total throughput and total data from all clients in 15 minute increments

Check connected wireless clients

Dashboard > Dashboard > 2.4GHz/5GHz Wireless

1. Log into your management page (see "[Access the management page](#)" on page 16).
2. Click on the **Status** tab and click **2.4G or 5G Wireless Client List**.

Current Usage

- 18:17:25:35:DA:1E
- 1E:17:25:35:DA:1E

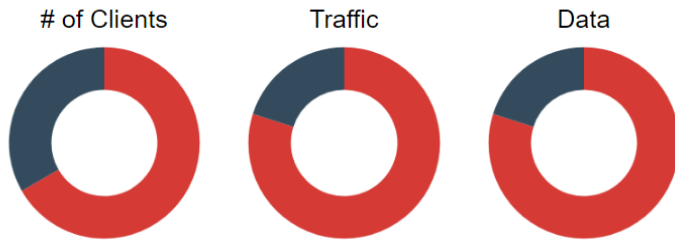

- **# of Clients:** Displays the number of clients on each SSID
- **Traffic:** Displays the amount of traffic being used broken down by the SSID
- **Data:** Displays the amount of data being used broken down by the SSID

Client List

Device Name	MAC Address	AP MAC Address	Download	Upload	History	Time	Action
iPhone	a6:b5:de:99:b7:c4	18:17:25:35:DA:1E	760.34MB	2.70MB		00:25:25	Blacklist Kick

- **Device Name:** Displays the name of the connected device connected to this specific wireless band
- **MAC Address:** Displays the MAC address of the client that is connected to the access point
- **AP MAC Address:** Displays the MAC Address of the SSID that the client is connected to
- **Download/Upload:** Total amount of data downloaded and uploaded by the connected device
- **History:** Displays the throughput of the client device over time.
- **Time:** Displays how long the device has been connected to the access point.
- **Kick and Blacklist:** Clicking this option will allow you to kick the client from the network or ban them as well

System Log

Status > System Log

System log keeps track of changes made to the access point.

1. Log into your management page (see [“Access the management page”](#) on page 13).
2. Click on the **Dashboard** tab and click **System Log**.

System Log

```

Nov 16 23:30:00 TEW-921DAP USER root pid 15595 cmd cameo-schedule-cron.sh
Nov 16 23:30:23 TEW-921DAP ath1: STA 0e:14:75:af:59:47 IEEE 802.11: associated (aid 1)
Nov 16 23:30:23 TEW-921DAP ath1: STA 0e:14:75:af:59:47 WPA: sending 1/4 msg of 4-Way Handshake
Nov 16 23:30:23 TEW-921DAP ath1: STA 0e:14:75:af:59:47 WPA: received EAPOL-Key frame (2/4 Pairwise)
Nov 16 23:30:23 TEW-921DAP ath1: STA 0e:14:75:af:59:47 WPA: sending 3/4 msg of 4-Way Handshake
Nov 16 23:30:23 TEW-921DAP ath1: STA 0e:14:75:af:59:47 WPA: received EAPOL-Key frame (4/4 Pairwise)
Nov 16 23:30:23 TEW-921DAP ath1: STA 0e:14:75:af:59:47 RADIUS: starting accounting session 05FE75C59261F583
Nov 16 23:30:23 TEW-921DAP ath1: STA 0e:14:75:af:59:47 WPA: pairwise key handshake completed (RSN)
Nov 16 23:31:00 TEW-921DAP USER root pid 18898 cmd cameo-schedule-cron.sh
Nov 16 23:31:13 TEW-921DAP ath0: STA ce:34:45:3c:35:00 IEEE 802.11: authenticated
Nov 16 23:31:13 TEW-921DAP ath0: STA ce:34:45:3c:35:00 IEEE 802.11: associated (aid 2)
Nov 16 23:31:13 TEW-921DAP ath0: STA ce:34:45:3c:35:00 WPA: sending 1/4 msg of 4-Way Handshake
Nov 16 23:31:13 TEW-921DAP ath0: STA ce:34:45:3c:35:00 WPA: received EAPOL-Key frame (2/4 Pairwise)
Nov 16 23:31:13 TEW-921DAP ath0: STA ce:34:45:3c:35:00 WPA: sending 3/4 msg of 4-Way Handshake
Nov 16 23:31:13 TEW-921DAP ath0: STA ce:34:45:3c:35:00 WPA: received EAPOL-Key frame (4/4 Pairwise)
Nov 16 23:31:13 TEW-921DAP ath0: STA ce:34:45:3c:35:00 RADIUS: starting accounting session F791CDB322019F8A
Nov 16 23:31:13 TEW-921DAP ath0: STA ce:34:45:3c:35:00 WPA: pairwise key handshake completed (RSN)
Nov 16 23:31:22 TEW-921DAP ath1: STA 0e:14:75:af:59:47 IEEE 802.11: disassociated
Nov 16 23:31:13 TEW-921DAP ath0: STA 88:e9:fe:78:11:97 IEEE 802.11: associated (aid 1)
Nov 16 23:31:50 TEW-921DAP ath0: STA 88:e9:fe:78:11:97 WPA: sending 1/4 msg of 4-Way Handshake
Nov 16 23:31:50 TEW-921DAP ath0: STA 88:e9:fe:78:11:97 WPA: received EAPOL-Key frame (2/4 Pairwise)
                    
```

Refresh Clear

- **Refresh:** Clicking **Refresh** allows the access point to update the log with any new data that has not been previously logged yet.
- **Clear:** Clears all the data saved previously onto the log.

IPv6 Status

Dashboard > IPv6 Status

1. Log into your management page (see [“Access the management page”](#) on page 13).
2. Click on the **Status** tab and click **IPv6 Status**.

Network	
IPv6 Connection Type	Local Connectivity Only
LAN IPv6 Link-Local Address	fe80::1a17:25ff:fe35:da1e/64

Technical Specifications

Standards

- IEEE 802.3
- IEEE 802.3u
- IEEE 802.3x
- IEEE 802.3ab
- IEEE 802.3at
- IEEE 802.1Q
- IEEE 802.11a
- IEEE 802.11b
- IEEE 802.11g
- IEEE 802.11k
- IEEE 802.11n (up to 400Mbps)*
- IEEE 802.11r
- IEEE 802.11v
- IEEE 802.11w
- IEEE 802.11ac Wave 2 (up to 867Mbps)*
- IEEE 802.11ax (up to 1201Mbps)*

Hardware Interface

- 1 x PoE+ Gigabit LAN port (power input)
- Power port (optional power adapter sold separately)
- LED indicators
- Mounting plate
- Reset button

Features

- MU-MIMO
- OFDMA
- Band steering
- WiFi traffic shaping
- 802.1Q VLAN assignment per SSID

- IPv6 support (Link-Local, Static IPv6, Auto-Configuration (SLAAC/DHCPv6))
- Multi-Language interface, English, French, Spanish, German, Russian
- LEDs on/off
- External Captive Portal (Coovachilli server authentication)
- Internal Captive Portal (Local user account authentication and customizable portal page)
- Redirect Captive Portal
- 802.11k intelligent radio resource management
- RSSI Threshold (client signal strength and connectivity control)
- Airtime Fairness
- IGMP Snooping

Operation Modes

- Access Point
- Client Bridge
- WDS AP
- WDS Bridge
- WDS Station
- Repeater

Management/Monitoring

- Web based management
- SNMP v1/v3
- STP
- Event logging
- Ping test
- Traceroute
- Telnet
- Reboot & scheduled automatic reboot

Access Control

- Wireless encryption: WEP, WPA/WPA2-PSK, WPA/WPA2-RADIUS, WPA3-PSK
- MAC filter

- Maximum client limit

QoS

- Bandwidth control per SSID or client

SSID

- Up to 8 SSIDs per wireless band (24 total)

Frequency

- 2.4GHz: 2.412 – 2.472GHz
- 5GHz: 5.180 – 5.320GHz

Wireless Channels

- 2.4GHz: FCC: 1–11, ETSI: 1 – 13
- 5GHz: FCC: 36, 40, 44, 48, 149, 153, 157, 161 and 165 ETSI: 36, 40, 44, 48 (52, 56, 60, 64, 100, 104, 108, 112, 116, 132, 136, 140) **

Modulation

- DBPSK/DQPSK/CCK for DSSS technique
- BPSK/QPSK/16-QAM/64-QAM/256-QAM/1024-QAM for OFDM technique
- OFDMA

Antenna Gain

- 2.4GHz: 2 x 3.2 dBi internal
- 5Ghz: 2 x 4.3 dBi internal

Wireless Output Power

- 802.11a: FCC: 30 dBm (max.) / CE: 28 dBm (max.)
- 802.11b: FCC: 29 dBm (max.) / CE: 18 dBm (max.)
- 802.11g: FCC: 29 dBm (max.) / CE: 19 dBm (max.)
- 802.11n (2.4GHz): FCC: 29 dBm (max.) / CE: 19 dBm (max.)
- 802.11n (5GHz): FCC: 30 dBm (max.) / CE: 28 dBm (max.)
- 802.11ac: FCC: 30 dBm (max.) / CE: 28 dBm (max.)

- 802.11ax (2.4GHz): FCC: 29 dBm / CE: 19 dBm
- 802.11ax (5GHz): FCC: 30 dBm / CE: 28 dBm

Receiving Sensitivity

- 802.11a: -75 dBm (typical) @ 54Mbps
- 802.11b: -90 dBm (typical) @ 11Mbps
- 802.11g: -77 dBm (typical) @ 54Mbps
- 802.11n (2.4 GHz): -77 dBm (typical) @ 400Mbps
- 802.11n (5 GHz): -71 dBm (typical) @ 400Mbps
- 802.11ac: -71 dBm (typical) @ 867 Mbps
- 802.11ax (2.4GHz): -65 dBm (typical) @ 574Mbps
- 802.11ax (5GHz): -63 dBm (typical) @ 1201Mbps

Power

- IEEE 802.3at Type 2 PoE PD Class 4
- Input: 100 - 240V AC, 50/60Hz, Output: 12V DC, 1.5A external power adapter (optional power adapter sold separately)
- Max. consumption: 15W

Operating Temperature

- 0° – 40° C (32° – 104° F)

Operating Humidity

- Max. 95% non-condensing

Certifications

- CE
- FCC

Dimensions

- 160 x 160 x 34mm (6.3 x 6.3 x 1.34 in.)

Weight

- 486g (1.07 lbs.)

Warranty:

- 3 year

Package Contents

- TEW-921DAP
- Network cable (1.5m/5 ft.)
- Quick Installation Guide
- Mounting plate

Disclaimer

*Maximum wireless signal rates are referenced from IEEE 802.11 theoretical specifications. Actual data throughput and coverage will vary depending on interference, network traffic, building materials and other conditions. For maximum performance of up to 1201Mbps, use with a 1201Mbps 802.11ax wireless adapter. For maximum performance of up to 867Mbps use with an 867Mbps 802.11ac wireless adapter. For maximum performance of up to 400Mbps, use with a 400Mbps 802.11n wireless adapter. Multi-User MIMO (MU-MIMO) requires the use of multiple MU-MIMO enabled wireless adapters.

**Due to regulatory requirements, the wireless channels specified cannot be statically assigned, but will be available within the available wireless channels when set to auto.

Troubleshooting

Q: I typed `http://192.168.10.1` in my Internet Browser Address Bar, but an error message says "The page cannot be displayed." How can I access the access point management page?

Answer:

1. Check your hardware settings again. See "[Getting Started](#)" on page 7.
2. Make sure the LAN and WLAN lights are lit.
3. Make sure your network adapter TCP/IP settings are set to *Obtain an IP address automatically* or *DHCP* (see the steps below).
4. Make sure your computer is connected to one of the router's LAN ports
5. Press on the factory reset button for 15 seconds, the release.

Windows 11/10/8.1/8/7

- a. Go into the **Control Panel**, click **Network and Sharing Center**.
- b. Click **Change Adapter Settings**, right-click the **Local Area Connection** icon.
- c. Then click **Properties** and click **Internet Protocol Version 4 (TCP/IPv4)**.
- d. Then click **Obtain an IP address automatically** and click **OK**.

Windows Vista

- a. Go into the **Control Panel**, click **Network and Internet**.
- b. Click **Manage Network Connections**, right-click the **Local Area Connection** icon and click **Properties**.
- c. Click **Internet Protocol Version (TCP/IPv4)** and then click **Properties**.
- d. Then click **Obtain an IP address automatically** and click **OK**.

Windows XP/2000

- a. Go into the **Control Panel**, double-click the **Network Connections** icon
- b. Right-click the **Local Area Connection** icon and the click **Properties**.
- c. Click **Internet Protocol (TCP/IP)** and click **Properties**.
- d. Then click **Obtain an IP address automatically** and click **OK**.

Note: *If you are experiencing difficulties, please contact your computer or operating system manufacturer for assistance.*

Q: I am not sure what type of Internet Account Type I have for my Cable/DSL connection. How do I find out?

Answer:

Contact your Internet Service Provider (ISP) for the correct information.

Q: The Wizard does not appear when I access the access point. What should I do?

Answer:

1. Click on Wizard on the left-hand side.
2. Near the top of the browser, "Pop-up blocked" message may appear. Right click on the message and select Always Allow Pop-ups from This Site.
3. Disable your browser's pop up blocker.

Q: I went through the Wizard, but I cannot get onto the Internet. What should I do?

Answer:

1. Verify that you can get onto the Internet with a direct connection into your modem (meaning plug your computer directly to the modem and verify that your single computer (without the help of the router) can access the Internet).
2. Power cycle your modem and router. Unplug the power to the modem and router. Wait 30 seconds, and then reconnect the power to the modem. Wait for the modem to fully boot up, and then reconnect the power to the router.
3. Contact your ISP and verify all the information that you have in regards to your Internet connection settings is correct.

Q: I cannot connect wirelessly to the access point. What should I do?

Answer:

1. Double check that the LAN light on the access point is lit.
2. Power cycle the router. Unplug the power to the router. Wait 15 seconds, then plug the power back in to the router.
3. Contact the manufacturer of your wireless network adapter and make sure the wireless network adapter is configured with the proper SSID. The preset SSID is TRENDnet (*model_number*).
4. To verify whether or not wireless is enabled, login to the router management page, click on *Wireless*.
5. Please see "[Steps to improve wireless connectivity](#)" on page 8 if you continue to have wireless connectivity problems.

Appendix

How to find your IP address?

Note: Please note that although the following procedures provided to follow for your operating system on configuring your network settings can be used as general guidelines, however, it is strongly recommended that you consult your computer or operating system manufacturer directly for assistance on the proper procedure for configuring network settings.

Command Prompt Method

Windows 2000/XP/Vista/7/8/8.1/10/11

1. On your keyboard, press **Windows Logo + R** keys simultaneously to bring up the Run dialog box.
2. In the dialog box, type **cmd** to bring up the command prompt.
3. In the command prompt, type **ipconfig /all** to display your IP address settings.

MAC OS X

1. Navigate to your **Applications** folder and open **Utilities**.
2. Double-click on **Terminal** to launch the command prompt.
3. In the command prompt, type **ipconfig getifaddr <en0 or en1>** to display the wired or wireless IP address settings.

Note: **en0** is typically the wired Ethernet and **en1** is typically the wireless Airport interface.

Graphical Method

MAC OS 10.6 – 10.12

1. From the Apple menu, select **System Preferences**.
2. In System Preferences, from the **View** menu, select **Network**.
3. In the Network preference window, click a network port (e.g., Ethernet, AirPort, modem). If you are connected, you'll see your IP address settings under "Status:"

MAC OS 10.4

1. From the Apple menu, select **Location**, and then **Network Preferences**.
2. In the Network Preference window, next to "Show:", select **Network Status**. You'll see your network status and your IP address settings displayed.

Note: If you are experiencing difficulties, please contact your computer or operating system manufacturer for assistance.

How to configure your network settings to obtain an IP address automatically or use DHCP?

Note: Please note that although the following procedures provided to follow for your operating system on configuring your network settings can be used as general guidelines, however, it is strongly recommended that you consult your computer or operating system manufacturer directly for assistance on the proper procedure for configuring network settings.

Windows 7 and up

- a. Go into the **Control Panel**, click **Network and Sharing Center**.
- b. Click **Change Adapter Settings**, right-click the **Local Area Connection** icon.
- c. Then click **Properties** and click **Internet Protocol Version 4 (TCP/IPv4)**.
- d. Then click **Obtain an IP address automatically** and click **OK**.

Windows Vista

- a. Go into the **Control Panel**, click **Network and Internet**.
- b. Click **Manage Network Connections**, right-click the **Local Area Connection** icon and click **Properties**.
- c. Click **Internet Protocol Version (TCP/IPv4)** and then click **Properties**.
- d. Then click **Obtain an IP address automatically** and click **OK**.

Windows XP/2000

- a. Go into the **Control Panel**, double-click the **Network Connections** icon
- b. Right-click the **Local Area Connection** icon and the click **Properties**.
- c. Click **Internet Protocol (TCP/IP)** and click **Properties**.
- d. Then click **Obtain an IP address automatically** and click **OK**.

MAC OS 10.4/10.5/10.6

- a. From the **Apple**, drop-down list, select **System Preferences**.
- b. Click the **Network** icon.
- c. From the **Location** drop-down list, select **Automatic**.
- d. Select and view your Ethernet connection.
 - In MAC OS 10.4, from the **Show** drop-down list, select **Built-in Ethernet** and select the **TCP/IP** tab.
 - In MAC OS 10.5/10.6, in the left column, select **Ethernet**.
- e. Configure TCP/IP to use DHCP.

In MAC 10.4, from the **Configure IPv4**, drop-down list, select **Using DHCP** and click the **Apply Now** button.

In MAC 10.5, from the **Configure** drop-down list, select **Using DHCP** and click the **Save** button.

In MAC 10.6, from the **Configure** drop-down list, select **Using DHCP** and click the **Save** button.

f. Restart your computer.

Note: If you are experiencing difficulties, please contact your computer or operating system manufacturer for assistance.

How to find your MAC address?

In Windows 2000/XP/Vista/7/8/8.1/10,

Your computer MAC addresses are also displayed in this window, however, you can type **getmac -v** to display the MAC addresses only.

In MAC OS 10.4,

1. **Apple Menu > System Preferences > Network**
2. From the **Show** menu, select **Built-in Ethernet**.
3. On the **Ethernet** tab, the **Ethernet ID** is your MAC Address.



In MAC OS 10.5/10.6,

1. **Apple Menu > System Preferences > Network**
2. Select **Ethernet** from the list on the left.
3. Click the **Advanced** button.
3. On the **Ethernet** tab, the **Ethernet ID** is your MAC Address.

How to connect to a wireless network using the built-in Windows utility?

Note: Please note that although the following procedures provided to follow for your operating system on configuring your network settings can be used as general guidelines, however, it is strongly recommended that you consult your computer or operating system manufacturer directly for assistance on the proper procedure for connecting to a wireless network using the built-in utility.

Windows 7/8/8.1/10/11

1. Open Connect to a Network by clicking the network icon ( or ) in the notification area.
2. In the list of available wireless networks, click the wireless network you would like to connect to, then click **Connect**.
4. You may be prompted to enter a security key in order to connect to the network.
5. Enter in the security key corresponding to the wireless network, and click **OK**.

Windows Vista

1. Open Connect to a Network by clicking the **Start Button**  and then click **Connect To**.
2. In the **Show** list, click **Wireless**.
3. In the list of available wireless networks, click the wireless network you would like to connect to, then click **Connect**.
4. You may be prompted to enter a security key in order to connect to the network.
5. Enter in the security key corresponding to the wireless network, and click **OK**.

Windows XP

1. Right-click the network icon in the notification area, then click **View Available Wireless Networks**.
2. In **Connect to a Network**, under **Available Networks**, click the wireless network you would like to connect to.
3. You may be prompted to enter a security key in order to connect to the network.
4. Enter in the security key corresponding to the wireless network, and click **Connect**.

Federal Communication Commission Interference Statement

This equipment has been tested and found to comply with the limits for a Class B digital device, pursuant to Part 15 of the FCC Rules. These limits are designed to provide reasonable protection against harmful interference in a residential installation. This equipment generates, uses and can radiate radio frequency energy and, if not installed and used in accordance with the instructions, may cause harmful interference to radio communications. However, there is no guarantee that interference will not occur in a particular installation. If this equipment does cause harmful interference to radio or television reception, which can be determined by turning the equipment off and on, the user is encouraged to try to correct the interference by one of the following measures:

- Reorient or relocate the receiving antenna.
- Increase the separation between the equipment and receiver.
- Connect the equipment into an outlet on a circuit different from that to which the receiver is connected.
- Consult the dealer or an experienced radio/TV technician for help.



FCC Caution: Any changes or modifications not expressly approved by the party responsible for compliance could void the user's authority to operate this equipment.

This device complies with Part 15 of the FCC Rules. Operation is subject to the following two conditions: (1) This device may not cause harmful interference, and (2) this device must accept any interference received, including interference that may cause undesired operation.

IMPORTANT NOTE:

Radiation Exposure Statement:

This equipment complies with FCC radiation exposure limits set forth for an uncontrolled environment. This equipment should be installed and operated with minimum distance 20cm between the radiator & your body.

This transmitter must not be co-located or operating in conjunction with any other antenna or transmitter.

Country Code selection feature to be disabled for products marketed to the US/CANADA

TRENDnet hereby declare that the product is in compliance with the essential requirements and other relevant provisions under our sole responsibility.

RoHS

This product is RoHS compliant.



Europe – EU Declaration of Conformity

TRENDnet hereby declare that the product is in compliance with the essential requirements and other relevant provisions under our sole responsibility.

- EN 62368-1:2014 + A11: 2017
- EN 55032:2015 + A11:2020
- EN 55024: 2010 + A1: 2015
- EN 55035:2017 + A11:2020
- EN 301 489-1 V2.2.3
- EN 301 489-17 V3.1.1
- EN 300 328 V2.2.2
- EN 301 893 V2.1.1
- EN 62311: 2008
- EN 50385: 2017



Energy Efficiency

Regulation (EC) No. 1275/2008, No. 278/2009, No. 801/2013

Directives:

Low Voltage Directive 2014/35/EU
 EMC Directive 2014/30/EU
 Radio Equipment Directive 2014/53/EU
 Ecodesign Directive 2009/125/EC
 RoHS Directive 2011/65/EU
 WEEE Directive 2012/19/EU
 REACH Regulation (EC) No. 1907/2006

Industry Canada Statement

This device complies with ISED's license-exempt RSSs. Operation is subject to the following two conditions: (1) This device may not cause harmful interference, and (2) this device must accept any interference received, including interference that may cause undesired operation.

Le présent appareil est conforme aux CNR d'ISED applicables aux appareils radio exempts de licence. L'exploitation est autorisée aux deux conditions suivantes: (1) le dispositif ne doit pas produire de brouillage préjudiciable, et (2) ce dispositif doit accepter tout brouillage reçu, y compris un brouillage susceptible de provoquer un fonctionnement indésirable.

Caution:

- (i) The device for operation in the band 5150-5250 MHz is only for indoor use to reduce the potential for harmful interference to co-channel mobile satellite systems;
- (ii) The maximum antenna gain permitted for devices in the bands 5250-5350 MHz and 5470-5725 MHz shall be such that the equipment still complies with the e.i.r.p. limit;
- (iii) The maximum antenna gain permitted for devices in the band 5725-5850 MHz shall be such that the equipment still complies with the e.i.r.p. limits as appropriate;
- (iv) Where applicable, antenna type(s), antenna moels(s), and worst-case tilt angle(s) necessary to remain compliant with the e.i.r.p. elevation mask requirement set forth in section 6.2.2.3 shall be clearly indicated.

Avertissement:

Le guide d'utilisation des dispositifs pour reseaux locaux doit inclure des instructions précises sur les restrictions susmentionnées, notamment:

- (i) Les dispositifs fonctionnant dans la bande 5150-5250 MHz sont réservés uniquement pour une utilisation à l'intérieur afin de réduire les risques de brouillage préjudiciable aux systems de satellites mobiles utilisant les mêmes canaux;
- (ii) Le gain maximal d'antenne permis pour les dispositifs utilisant les bandes de 5250 à 5350 MHz et de 5470 à 5725 MHz doit être conforme à la limite de la p.i.r.e.;
- (iii) Le gain maximal d'antenne permis (pour les dispositifs utilisant la bande de 5725 à 5850 MHz) doit être conforme à la limite de la p.i.r.e. spécifiée, selon le cas;
- (iv) Lorsqu'il y a lieu, les types d'antennes (s'il y en a plusieurs), les numéros de modèle de l'antenne et les pires angles d'inclinaison nécessaires pour rester conforme à

l'exigence de la p.i.r.e. applicable au masque d'élévation, énoncée à la section 6.2.2.3, doivent être clairement indiqués

Radiation Exposure Statement:

This equipment complies with ISED radiation exposure limits set forth for an uncontrolled environment. This equipment should be installed and operated with greater than 20cm between the radiation & your body.

Déclaration d'exposition aux radiations:

Cet équipement est conforme aux limites d'exposition aux rayonnements ISED établies pour un environnement non contrôlé. Cet équipement doit être installé et utilisé à plus de 20cm entre le radiateur et votre corps.

Limited Warranty

TRENDnet warrants only to the original purchaser of this product from a TRENDnet authorized reseller or distributor that this product will be free from defects in material and workmanship under normal use and service. This limited warranty is non-transferable and does not apply to any purchaser who bought the product from a reseller or distributor not authorized by TRENDnet, including but not limited to purchases from Internet auction sites.

Limited Warranty

TRENDnet warrants its products against defects in material and workmanship, under normal use and service. Specific warranty periods are listed on each of the respective product pages on the TRENDnet website.

- AC/DC Power Adapter, Cooling Fan, and Power Supply carry a one-year warranty.

Limited Lifetime Warranty

TRENDnet offers a limited lifetime warranty for all of its metal-enclosed network switches that have been purchased in the United States/Canada on or after 1/1/2015.

- Cooling fan and internal power supply carry a one-year warranty

To obtain an RMA, the ORIGINAL PURCHASER must show Proof of Purchase and return the unit to the address provided. The customer is responsible for any shipping-related costs that may occur. Replacement goods will be shipped back to the customer at TRENDnet's expense.

Upon receiving the RMA unit, TRENDnet may repair the unit using refurbished parts. In the event that the RMA unit needs to be replaced, TRENDnet may replace it with a refurbished product of the same or comparable model.

In the event that, after evaluation, TRENDnet cannot replace the defective product or there is no comparable model available, we will refund the depreciated value of the product.

If a product does not operate as warranted during the applicable warranty period, TRENDnet shall reserve the right, at its expense, to repair or replace the defective product or part and deliver an equivalent product or part to the customer. The repair/replacement unit's warranty continues from the original date of purchase. All products that are replaced become the property of TRENDnet. Replacement products may be new or reconditioned. TRENDnet does not issue refunds or credit. Please contact the point-of-purchase for their return policies.

TRENDnet shall not be responsible for any software, firmware, information, or memory data of customer contained in, stored on, or integrated with any products returned to TRENDnet pursuant to any warranty.

There are no user serviceable parts inside the product. Do not remove or attempt to service the product by any unauthorized service center. This warranty is voided if (i) the product has been modified or repaired by any unauthorized service center, (ii) the product was subject to accident, abuse, or improper use, or (iii) the product was subject to conditions more severe than those specified in the manual.

Warranty service may be obtained by contacting TRENDnet within the applicable warranty period and providing a copy of the dated proof of the purchase. Upon proper submission of required documentation, a Return Material Authorization (RMA) number will be issued. An RMA number is required in order to initiate warranty service support for all TRENDnet products. Products that are sent to TRENDnet for RMA service must have the RMA number marked on the outside of return packages and sent to TRENDnet prepaid, insured and packaged appropriately for safe shipment. International customers shipping from outside of the USA and Canada are responsible for any return shipping and/or customs charges, including but not limited to, duty, tax, and other fees.

Refurbished product: Refurbished products carry a 90-day warranty after date of purchase. Please retain the dated sales receipt with purchase price clearly visible as

evidence of the original purchaser's date of purchase. Replacement products may be refurbished or contain refurbished materials. If TRENDnet, by its sole determination, is unable to replace the defective product, we will offer a refund for the depreciated value of the product.

WARRANTIES EXCLUSIVE: IF THE TRENDNET PRODUCT DOES NOT OPERATE AS WARRANTED ABOVE, THE CUSTOMER'S SOLE REMEDY SHALL BE, AT TRENDNET'S OPTION, REPAIR OR REPLACE. THE FOREGOING WARRANTIES AND REMEDIES ARE EXCLUSIVE AND ARE IN LIEU OF ALL OTHER WARRANTIES, EXPRESSED OR IMPLIED, EITHER IN FACT OR BY OPERATION OF LAW, STATUTORY OR OTHERWISE, INCLUDING WARRANTIES OF MERCHANTABILITY AND FITNESS FOR A PARTICULAR PURPOSE. TRENDNET NEITHER ASSUMES NOR AUTHORIZES ANY OTHER PERSON TO ASSUME FOR IT ANY OTHER LIABILITY IN CONNECTION WITH THE SALE, INSTALLATION, MAINTENANCE, OR USE OF TRENDNET'S PRODUCTS.

TRENDNET SHALL NOT BE LIABLE UNDER THIS WARRANTY IF ITS TESTING AND EXAMINATION DISCLOSE THAT THE ALLEGED DEFECT IN THE PRODUCT DOES NOT EXIST OR WAS CAUSED BY CUSTOMER'S OR ANY THIRD PERSON'S MISUSE, NEGLIGENCE, IMPROPER INSTALLATION OR TESTING, UNAUTHORIZED ATTEMPTS TO REPAIR OR MODIFY, OR ANY OTHER CAUSE BEYOND THE RANGE OF THE INTENDED USE, OR BY ACCIDENT, FIRE, LIGHTNING, OR OTHER HAZARD.

LIMITATION OF LIABILITY: TO THE FULL EXTENT ALLOWED BY LAW, TRENDNET ALSO EXCLUDES FOR ITSELF AND ITS SUPPLIERS ANY LIABILITY, WHETHER BASED IN CONTRACT OR TORT (INCLUDING NEGLIGENCE), FOR INCIDENTAL, CONSEQUENTIAL, INDIRECT, SPECIAL, OR PUNITIVE DAMAGES OF ANY KIND, OR FOR LOSS OF REVENUE OR PROFITS, LOSS OF BUSINESS, LOSS OF INFORMATION OR DATA, OR OTHER FINANCIAL LOSS ARISING OUT OF OR IN CONNECTION WITH THE SALE, INSTALLATION, MAINTENANCE, USE, PERFORMANCE, FAILURE, OR INTERRUPTION OF THE POSSIBILITY OF SUCH DAMAGES, AND LIMITS ITS LIABILITY TO REPAIR, REPLACEMENT, OR REFUND

OF THE PURCHASE PRICE PAID, AT TRENDNET'S OPTION. THIS DISCLAIMER OF LIABILITY FOR DAMAGES WILL NOT BE AFFECTED IF ANY REMEDY PROVIDED HEREIN SHALL FAIL OF ITS ESSENTIAL PURPOSE.

Governing Law: This Limited Warranty shall be governed by the laws of the state of California.

Some TRENDnet products include software code written by third party developers. These codes are subject to the GNU General Public License ("GPL") or GNU Lesser General Public License ("LGPL").

Visit <http://www.trendnet.com/gpl> or the support section on <http://www.trendnet.com> and search for the desired TRENDnet product to access to the GPL Code or LGPL Code. These codes are distributed WITHOUT WARRANTY and are subject to the copyrights of the developers. TRENDnet does not provide technical support for these codes. Please visit <http://www.gnu.org/licenses/gpl.txt> or <http://www.gnu.org/licenses/lgpl.txt> for specific terms of each license.

PWP07172015v3

2018/7/30



Product Warranty Registration

Please take a moment to register your product online.
Go to TRENDnet's website at <http://www.trendnet.com/register>

Please ensure your switch's firmware version is V2.10.010 or newer for full support of Layer 2+ management features. See the Firmware Upgrade section in this document for additional information regarding the firmware upgrade procedure.

TRENDnet
20675 Manhattan Place
Torrance, CA 90501. USA