

USER'S GUIDE



TE100-P1P TE100-P1U

- 10/100Mbps Mini Print Server with 1 Parallel Printer Port
- 10/100Mbps Mini Print Server with 1 USB Printer Port

TRENDnet[®]
TRENDware, USA

Copyright © TRENDware International, Inc. 2003. All Rights Reserved.

Table of Contents

Chapter 1 Introduction	1
Features.....	1
Safety Instructions	2
Package Contents.....	3
Hardware Details	3
Chapter 2 LAN Installation	6
Procedure.....	6
Chapter 3 Print Server Configuration	7
Overview	7
Using the Windows Wizard.....	7
Chapter 4 Client PC Configuration	9
Overview	9
Windows Peer to Peer Printing.....	11
Windows SMB Printing.....	18
Windows with Server-based Print Queues	20
Macintosh (AppleTalk).....	21
Macintosh OS X	22
Chapter 5 BiAdmin Management Utility	24
Requirements.....	24
Installation	24
Operation	24
Chapter 6 Web-Based Management	34
Overview	34
Preparation.....	34
Connecting to the Print Server.....	35
Configuration Screens	35
Chapter 7 Special Features	40
Overview	40
Internet Printing Protocol(IPP).....	40
Internet Mail Printing	44
Chapter 8 Troubleshooting	49
Overview	49
Hardware & LAN Problems	49
AppleTalk (Macintosh).....	50
Windows Printing Problems	52

Unix Troubleshooting.....	56
Appendix A Specifications	57
General Specifications.....	57
Appendix B Windows Server Configuration	59
Windows NT 4.0 Server	59
Windows 2000/2003 Server	60
Appendix C Unix Systems	61
Overview	61
Print Server IP Address Configuration	61
Other Print Server Configuration.....	61
LPD Printing.....	62
Appendix D NetWare	67
Overview	67
Creating an NDPS Manager Object.....	67
Creating an NDPS Printer Agent.....	68

Chapter I

Introduction

This chapter provides an overview of your Print Server's features.

Features

Congratulations on the purchase of your new Print Server. Your Print Server was designed to provide a simple and efficient network printing solution. It is packed with features, including:

- ***Versatility.*** The Print Server supports up to four protocols: TCP/IP, SMB (Service Message Block), AppleTalk (EtherTalk), and NetBEUI. It features a 10/100BaseT Ethernet interface port for connection to your LAN and operating system support includes Unix, NetWare (NDPS LPR printing), and Microsoft Windows.
- ***Easy Installation.*** The Print Server makes adding printers or plotters to your network simple.
- ***Easy Setup.*** A number of utility programs are supplied to simplify setup. For Windows 95/98/Me/NT/2000/XP users, the BiAdmin program makes it easy to configure the Print Server for a variety of network and server configurations.
- ***Web-based Interface.*** The Web-based interface provides an easy method of configuration in TCP/IP networks regardless of your operating system.
- ***Compact Size.*** This allows the Print Server to be used even where space is limited.
- ***Remote Management Tools.*** A variety of software tools are provided. In most environments, both the Print Server and attached bi-directional printers can be configured remotely.
- ***Internet Printing Protocol (IPP) Support.*** The Print Server can act as an IPP (Internet Printing Protocol) Server, allowing clients, suppliers, colleagues and others to print to your printer from anywhere on the Internet. Windows IPP Client software is also supplied on the CD-ROM.

Safety Instructions

For your own safety, and to protect your Print Server, please observe the following safety advice.

1. Unplug this device from its power source before cleaning. Use only a slightly dampened cloth for cleaning. Do not use liquid or aerosol cleaners.
2. Avoid using this product near water. Exposure to water poses an electric-shock hazard.
3. Do not place the Print Server on an unstable surface. The device may fall causing serious damage to the device.
4. This device should only be used with the power supply type specified on the marking label. If you are not sure of type of your local power supply, consult your dealer or the local power company.
5. Do not pinch, crimp or otherwise damage the power cord. If exposed to foot traffic, ensures that the cable is properly shielded and does not pose a tripping hazard.
6. If using an extension cord, makes sure the total ampere rating of the products using the cord does not exceed the extension cord's ampere rating.
7. Do not attempt to service this device, as opening or removing casing may expose you to dangerous voltage points or other risks. Refer all servicing to qualified service personnel.
8. The Print Server should be serviced by qualified service personnel under the following conditions:
 - The power cord is damaged or frayed.
 - Liquid has been spilled onto the product.
 - The product has been exposed to rain or water.
 - The product does not operate normally in accordance with the operating instructions.
 - The device has been dropped or the casing has been damaged.

Package Contents

You should find the following items packaged with your Print Server. If any items are missing, contact your dealer immediately.

- The Print Server unit
- Power Adapter
- One CD-ROM containing all support programs and this manual
- Quick Install Guide

Hardware Details

Details of the LEDs and connections are in this Chapter. Further details are contained in *Appendix A - Specifications*.

TE100-P1U Print Server

- 1 USB Printer Port
- 10/100BaseT LAN connection

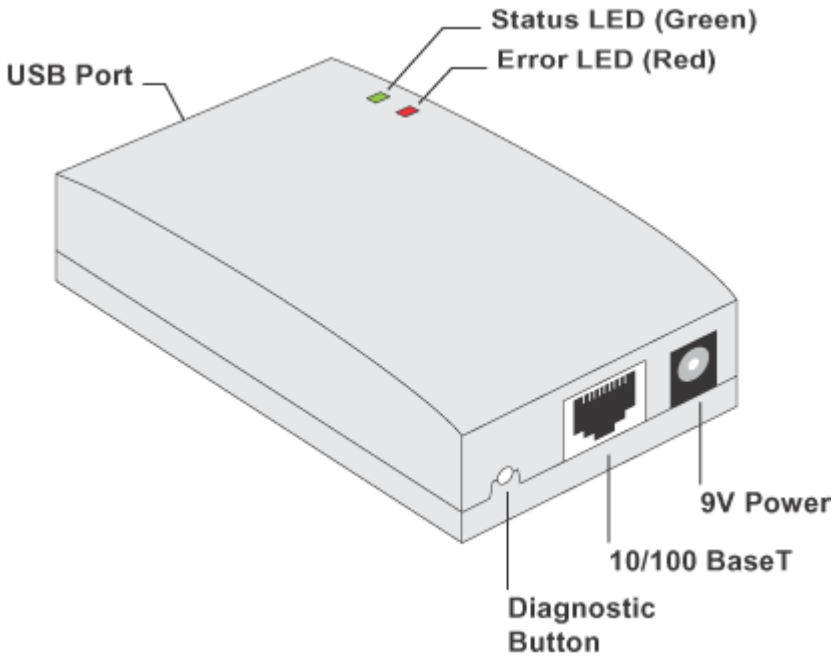

Figure 1: TE100-P1U Print Server

TE100-P1P Print Server

- Direct Attach
- 1 Parallel Port
- 10/100BaseT

Parallel Port

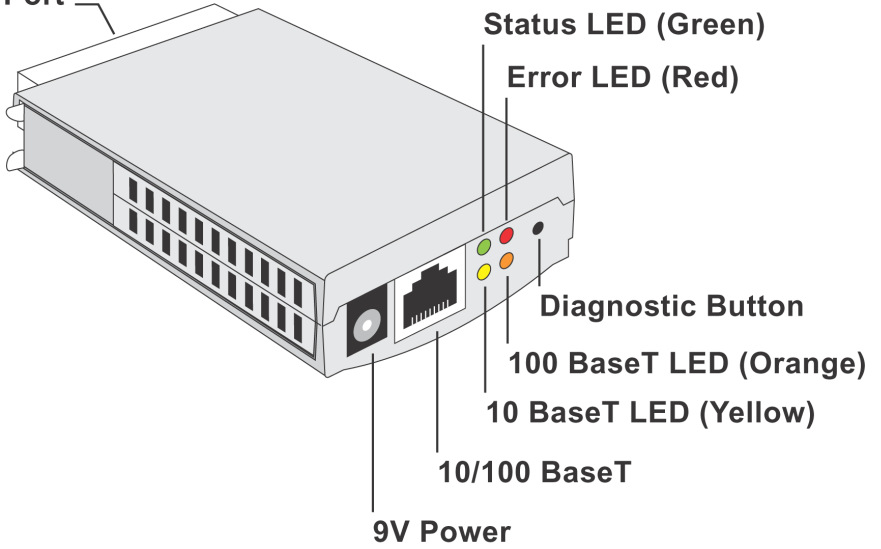

Figure 2: TE100-P1P Print Server

LED Indicators

The TE100-P1U has two LED indicators on the top; the TE100-P1P's LEDs are on the end. The Error LED is red. The Status indicator LED is green. The LED indicator modes are described in the following table.

Status LED (Green)	Error LED (Red)	Status Description
Off	Off	No power.
On	Off	Normal operation - Idle.
Flashing	Off	Normal operation - transmitting or receiving packets from the network.
On	On	Hardware error.
On	Flashing (USB only)	No printer connected to the USB port.
Flashing	Flashing	Firmware upgrade in progress.

Diagnostic Push Button

The button is recessed; a pin or paper clip can be used to press it. This button has 2 functions:

- Restore the factory default settings
- Print a test page containing all current settings.

To restore the factory default settings:

1. Turn the Print Server OFF.
2. Press and hold the diagnostic button. While pressing the button, switch the Print Server ON.
3. If you continue pressing the button for 10 seconds, a diagnostic page will be printed, showing the new (default) settings.

To generate a Diagnostic print out

1. Ensure that both the Print Server and the attached printer are ON.
2. Press the diagnostic button, and hold it in for 2 seconds.
3. The test page, containing the current settings, will be printed.

Note:

PostScript printers are unable to print this page. If you have a PostScript printer, the test page will not be printed.

Chapter 2

LAN Installation

This chapter describes how to install the Print Server in your Local Area Network.

Procedure

1. Preparation

- Ensure the power is OFF. Do not connect the Print Server while power is On.
- Find the *Default Server Name* for your Print Server. The *Default Server Name* is shown on a sticker on the base of the device. It consists of 8 letters and/or digits. Record this name; it may be needed during configuration.

2. Connect the Printer

- For the TE100-P1U, use the cable supplied with your printer to connect the printer to the USB port on the Print Server unit.
- For the TE100-P1P, connect the male parallel port on the Print Server directly to the printer.

3. Connect the Network Cable

- Connect the network cable to the 10/100BaseT LAN connector on the Print Server.

4. Power Up

Plug in the power adapter cable and power up. Start-up will take only a few seconds.

Use only the Power Supply unit provided with the Print Server. Using a different Power Supply may cause damage.

5. Check the LEDs

- The Error LED should flash, then turn Off. When the Error LED goes off and the Status LED remains lit or flashes, the Print Server is ready.
- On the TE100-P1P, either the 10BaseT (yellow) LED or the 100BaseT (orange) LED should be On.
- On the TE100-P1U, the Error LED will remain flashing if the Print Server can't connect to the USB printer.

Chapter 3

Print Server Configuration

This chapter provides an overview of the configuration process.

Overview

The Print Server is designed to support many different platforms, and the configuration required would depend upon the environment in which it is installed.

- The Print Server usually requires configuration, but if there's a DHCP server on your network, then the device is just plug-and-play. A Windows-based setup Wizard is also provided on the CD-ROM to simplify this task.
- PCs wishing to use the printer attached to the Print Server always require configuration. See *Chapter 4- Client Configuration* for details.
- If you wish to use a queue-based printing system using **Windows NT Server/Windows 2000/Windows XP**, the Network Server must be configured as detailed in *Appendix B - Windows Server Configuration*. However, it is not necessary to use a Network Server-based queue; client PCs can print directly to the Print Server using the *Peer-to-peer Printing* installed by the *User* setup option on the CD-ROM.

Configuration Methods

The following methods are available to perform the required Print Server configuration:

- **Windows-based Wizard** - see below for details.
- **BiAdmin** management utility program - see Chapter 8 for details.
- **Web-based setup** - see Chapter 6 for details.

Advanced Configuration and Management

The BiAdmin management utility is provided for advanced configuration and management. This program is installed by default when the *Administrator* install option is chosen. See Chapter 5 for details on using BiAdmin.

Using the Windows Wizard

The Windows-based Wizard is supplied on the CD-ROM, and runs on Windows 95, 98, NT4.0, ME, Windows 2000 and Windows XP.

Using this Wizard is the recommended method to configure the Print Server.

It can be used to configure the Print Server for your Network environment, even if the Print Server does not have a valid IP address.

Procedure

1. Insert the supplied CD-ROM into your drive. If the setup program does not start automatically, run *SETUP.exe* in the root folder.
2. On the first screen, shown below, click *Setup Wizard*.



Figure 3: Print Server Screen

3. Click *Next* on the first screen of the Wizard, to view a list of Print Servers on your LAN.
4. Select your new Print Server, then click *Next* to continue.
5. Enter the required data on the following screen.
 - Name of the Print Server can be changed if you wish.
 - Comment is optional.
 - Select or enter the Workgroup name for this Print Server.
6. Click *Next* to configure the **TCP/IP Screen**:
 - Select *Obtain IP Address automatically* if your LAN has a DHCP Server, otherwise select *Fixed IP Address*.
 - For *Fixed IP Address*, enter an unused address from the range used on your LAN, or click the *Suggest New Values* Button.
Use the same *Network Mask* and *Gateway* as PCs on your LAN.
7. Click *Finish* to save the data to the Print Server.

Note: To install the Wizard on your PC, use the "Installation" option.

If the desired Print Server is not listed:

- Check all cables to the Print Server.
- Check the Print Server's LEDs:
The Red LED should be OFF and the Green LED should be ON or flashing.

Chapter 4

Client PC Configuration

The chapter details the client configuration required on LAN clients to use the printer or printers attached to the Print Server.

Overview

Before performing client configuration, the Print Server must be installed on your LAN, and configured as described in Chapter 3. Both the Print Server and the attached printer must be powered ON.

Printing Methods

The Print Server supports a number of printing methods:

- **Peer-to-peer Printing** means that the print jobs are stored (queued) on your PC, and sent directly to the Print Server when it is available.
- **Server-based Print Queue** means that all print jobs are stored (queued) on the Network Server (e.g. Windows NT/2000) and then sent to the Print Server. This allows the Network Administrator to modify the Print Queue. For example, an important job can be moved to the head of the queue.
- **Windows SMB** printing is a Microsoft standard for using a "Network Printer". No additional software needs to be installed on your Windows PC, and printing from MS-DOS programs is supported. However, because the Print Server can not store files, large print jobs may cause problems.
- **AppleTalk** is also supported, and normally no configuration of the Print Server is required. See the Macintosh section of this chapter for details of client configuration.

Which printing method should I use?

- If using Windows 95, 98, NT, Me, 2000, or XP, the easiest method to use is *Peer-to-peer Printing*.
- If using Windows, and you need to print from MS-DOS programs, or you don't wish to install additional software, use SMB. However, SMB is not suitable for large, complex documents, so if you need this as well as MS-DOS printing, you should install BOTH *Peer-to-peer Printing* and SMB printing. MS-DOS programs can use the SMB printer, Windows programs should use *Peer-to-peer Printing*.
- If your LAN has Network Servers (e.g. Windows NT, Windows 2000 Server) use the method advised by your Network Administrator. The Print Server can print via a queue located on a Network server, if desired.
- **Unix** users - refer to *Appendix C - Unix Systems*
- **Macintosh** users - refer to the Macintosh section of this chapter.

Checking your Network Protocols (Windows 9x)

Your PC must have EITHER the TCP/IP or NetBEUI protocols installed. (All versions of Windows after Windows 95 have TCP/IP installed by default.)

- If using the *Peer-to-peer Printing*, the installation program will check this for you.
 - If using other methods, you must check manually, as follows:
1. Select the *Settings - Control Panel - Network* option on the Start Menu. You should see a screen like the one following:

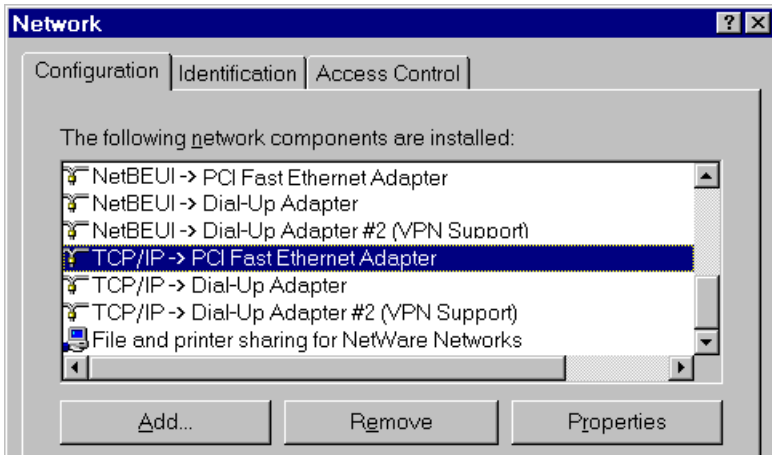

Figure 4: Network Configuration

- The top line in the list (NetBEUI -> PCI Fast Ethernet Adapter) indicates that the NetBEUI protocol is installed on this PC. Your PC will show the name of the your Network card rather than "PCI Fast Ethernet Adapter".
 - The highlighted line (TCP/IP -> PCI Fast Ethernet Adapter) indicates that TCP/IP is installed. Your PC will show the name of the your Network card rather than "PCI Fast Ethernet Adapter".
2. If neither line is present:
 - Install the NetBEUI protocol by selecting *Add - Protocol - Microsoft - NetBEUI - OK*. You may be prompted for your Windows CD-ROM.
 - If required, you can also install TCP/IP. However, depending on your LAN environment, TCP/IP may require further configuration.
 3. If either protocol is already installed, proceed with installation.

Windows Peer to Peer Printing

With this printing method, print jobs are stored (queued) on your PC, and then sent to the Print Server when it is available.

PTP (Peer-to-Peer) Printing

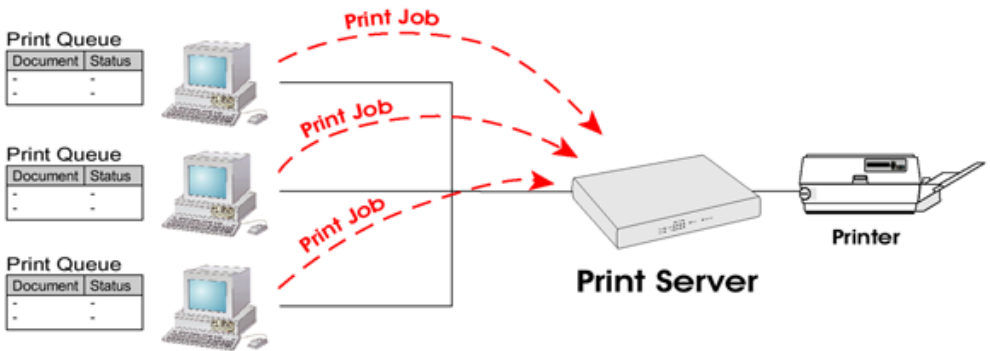

Figure 5: Peer-to-Peer Printing

Windows 2000 & XP require no additional software.

For other versions of Windows, the supplied PTP (Peer-to-Peer) Printer Port software must be installed on each PC.

Windows 2000/XP Setup

The recommended printing method is to use LPR, as follows:

1. Open your *Printers* folder, right-click the desired printer and select *Properties*.
2. When prompted, choose the *Ports* tab and click the *Add Port* button.

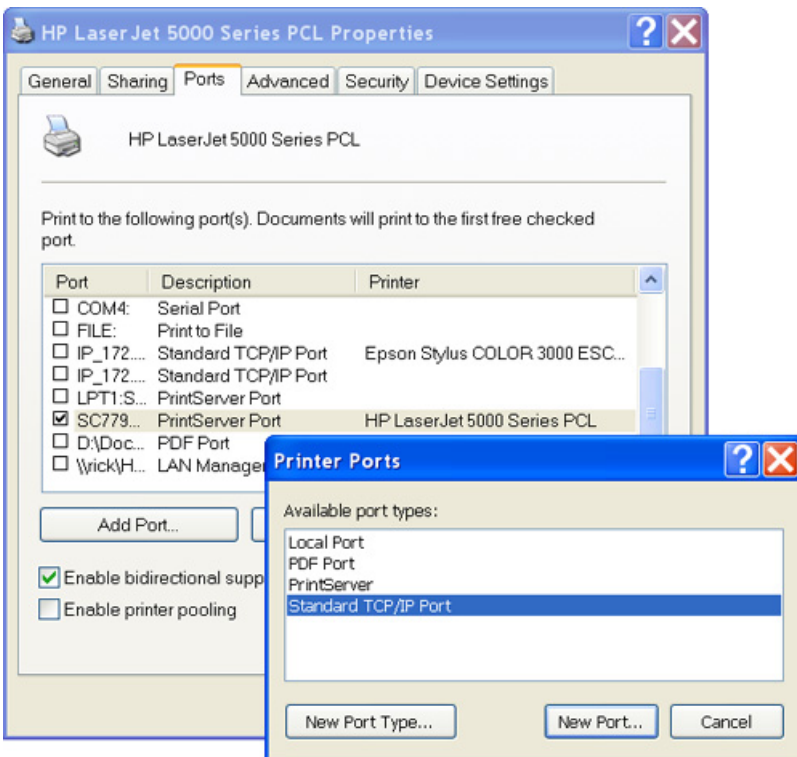

Figure 6: Printer Ports Screen

3. Choose Standard *TCP/IP Port*, then click *New Port*.

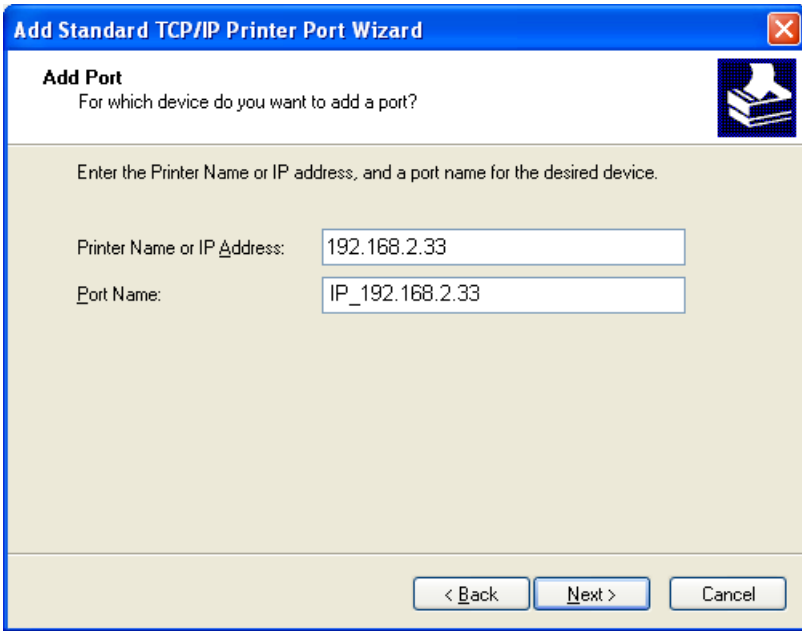

Figure 7: Add Port Screen

4. On the *Add Standard TCP/IP Printer Port* screen above, enter the *IP Address* of the Print Server in the *Printer Name or IP Address* field, then click *Next*.

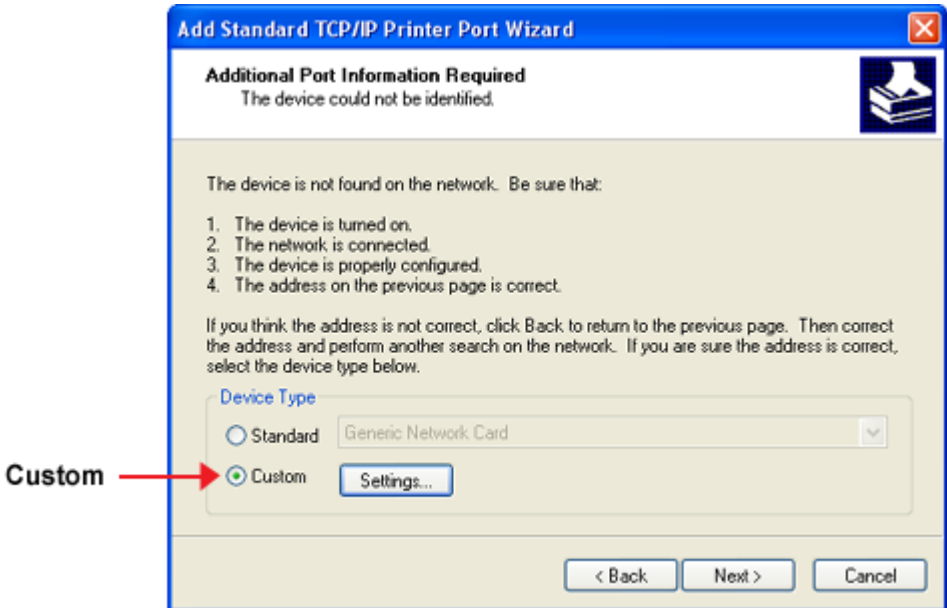

Figure 8: Additional Port Information Screen

5. On this screen, select *Custom*, and click the *Settings* button to view the screen below.

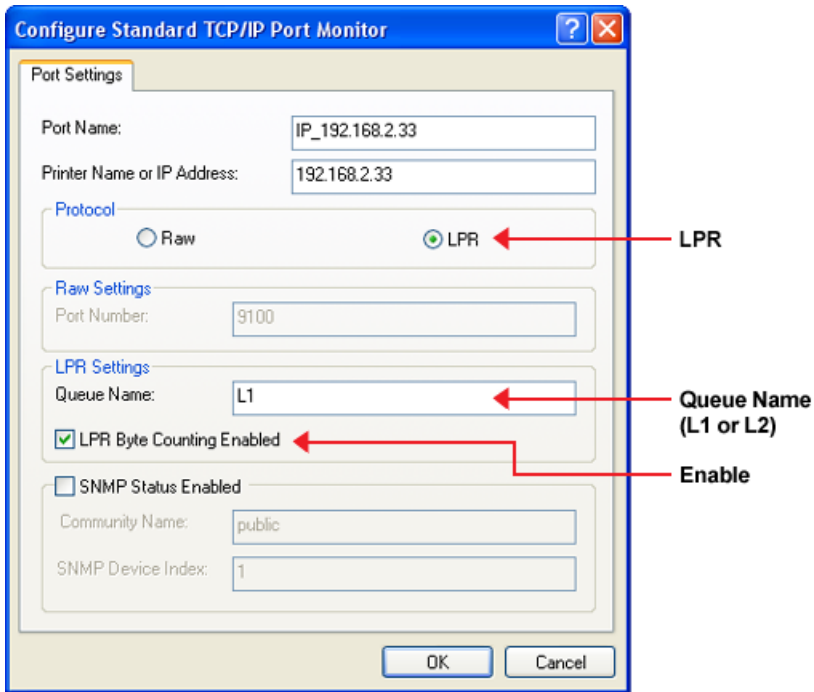

Figure 9: Port Settings Screen

6. On the *Port Settings* screen, shown above:
 - Select *LPR* in the *Protocol* section
 - Enter a *Queue name* (L1 for Port 1, L2 for Port 2 if the Print Server has 2 printer ports)
 - Ensure the *LPR Byte Counting Enabled* setting is **Enabled**.
 - Click OK to confirm your changes and close this screen.
7. Follow the prompts to complete the Wizard.

Windows 9x/ME Setup

Before performing the following procedure, the Print Server must be installed on your LAN, and configured as described in Chapter 3. Both the Print Server and the attached printer should be powered ON.

1. Insert the supplied CD-ROM into your drive. If the setup program does not start, run SETUP.exe in the root folder.
2. Click the *Installation* button, then select the *User Install*.



Figure 10: Installation Screen

3. Follow the prompts to complete the installation of the Peer-to-peer Printer Port Driver. (Refer to the *Windows* section of *Chapter 8 - Troubleshooting* if there is a problem with the installation.)
4. The *Print Driver Setup* will then run.

In future, you can use *Start - Programs - PrintServer Driver - Printer Port Setup* to run the program again.

PTP Printer Port Setup

1. The program will search for Printer Servers on the network, and a screen like the following will be displayed.
 - If desired, click *Refresh*.
 - The name of the attached printer will be displayed if possible. If "No printer" is displayed, check that the printer is properly connected and powered on.

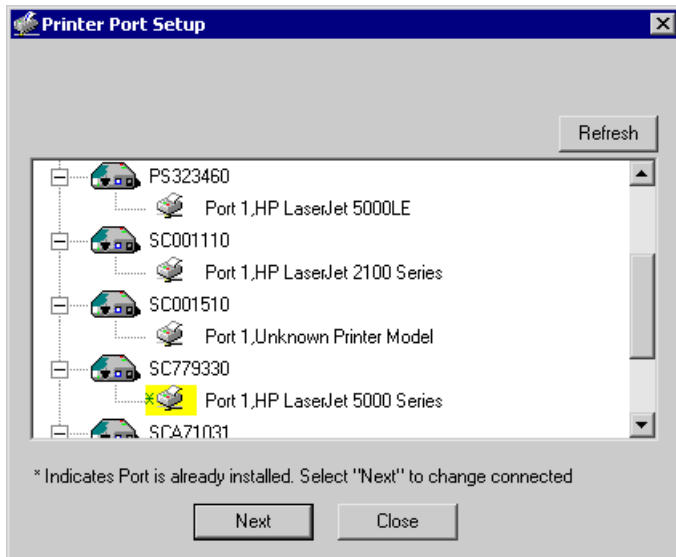

Figure 11: Print Port Setup (Peer-to-peer Printing)

If your Print Server is not listed:

- Click the "Refresh" button.
- Check that both the Print Server and the printer are properly connected, and powered on.
- Check that the Print Server has been configured. (Use the *Setup Wizard* on the CD-ROM.)
- If using TCP/IP, try installing the NetBEUI protocol. Then try again.

2. Select the desired port on a Print Server, then click *Next*. A pop-up message will inform you if the port has been created successfully.



If you see the following error message, either install Internet Explorer 4 or later, or follow the procedure in the "Trouble Shooting - Windows" section of Chapter 8.

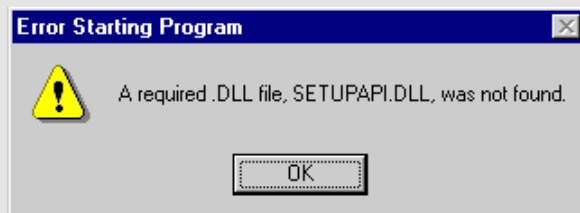

- The printer port will be created, then a screen like the following will be displayed.

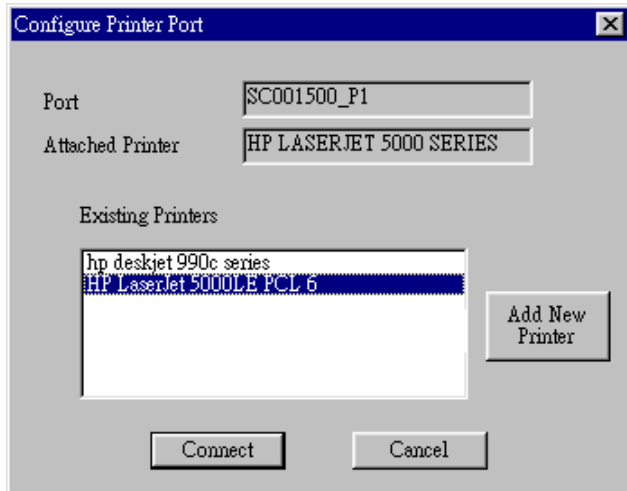

Figure 12: Configure Printer Port

- Select the correct Windows printer in the *Existing Printers* list, and click the *Connect* button.

If the correct printer type is not listed, click "Add New Printer" to run the Windows *Add Printer* wizard. Step through the Wizard and install the required printer:

- Select the correct Printer Manufacturer and Model, or use the "Have Disk" option if appropriate.
 - We recommend changing the Printer name to indicate which device is on. (e.g. HP2100 on SCA43600_P1)
 - If prompted about Sharing the printer, do NOT enable Sharing.
 - When the Printer installation is finished, it will be listed in the *Configure Printer Port* screen above. Select it and click *Connect*.
- Installation is now complete. You can now print using this printer.
 - To install additional Printers, repeat steps 4.
 - Use the **Start** menu to run this program in future. The default installation is *Start - Programs - PrintServer Driver - Print Driver Setup*.

Note:

If using the **Epson Spooler Manager**, this program must be disabled, as follows:

- Run the *Epson Spooler Manager*.
- Select "Queue Setup" from the menu.
- Click "Use Print Manager for this port".
- Click "OK" to exit.

Management

- Print jobs can be managed like any Windows printer. Open the *Printers* folder (*Start - Settings - Printers*) and double-click any printer to see the current print jobs.
- If the printer attached to the Print Server is changed, just run this program again, and select the correct printer.
- To delete a port created by this setup program, use the Windows *Delete Port* facility:
 - Right-click any printer in the *Printers* folder, and select *Properties*.

- Locate the *Delete Port* button. This button is on the *Details* or *Ports* tab, depending on your version of Windows.
- If the Print Server's IP Address is changed, and you can no longer print, delete the port (see procedure above) and re-install it.

Advanced Port Options

The options for the *Peer-to-peer Printing* are accessed via the *Port Settings* button.

Use *Start - Settings - Printers* to open the Printers folder, then right-click the Printer, and select *Properties*. The *Port Settings* button is on the *Details* or *Ports* tab, depending on your version of Windows.

An example screen is shown below:

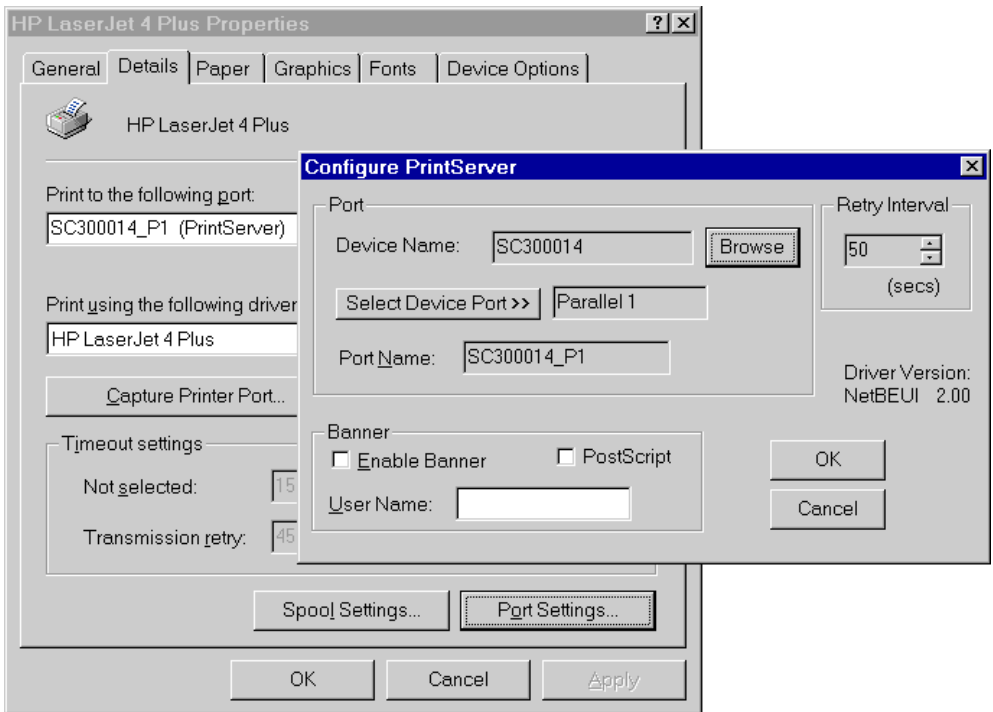

Figure 13: Port Settings (Peer-to-peer Driver)

Items shown on this screen are as follows:

Port	<p>If desired, click <i>Browse</i> to select a different Print Server. If the selected device has multiple ports, the <i>Select Device Port</i> button can be used to select the port.</p> <p>The <i>Port Name</i> can not be changed after installation. This name is shown in the Printer's <i>Properties</i>.</p>
Banner	<p>Check this option to print a banner page before each print job.</p> <ul style="list-style-type: none"> • If using a PostScript Printer, check the <i>PostScript</i> box. • The <i>User Name</i> will be printed on the banner page.
Retry Interval	<p>Sets how often Windows will poll the Print Server to establish a connection when the printer is busy. Increase this value if you get too many warning messages.</p>

Windows SMB Printing

This method requires no additional software to be installed, but the NetBEUI or TCP/IP protocol must be installed on your PC. Use the following procedure to install the Print Server's printer as a Windows SMB network printer:

1. Double-click the *Network Neighborhood* icon on the desktop.
2. On the *View* menu, select *Details*.
3. Locate the desired Print Server, as shown below:
 - If it is the same Workgroup as your PC, it will be listed on screen.
 - If it is in a different workgroup, double-click *Entire Network*, then double-click the appropriate Workgroup to open it.

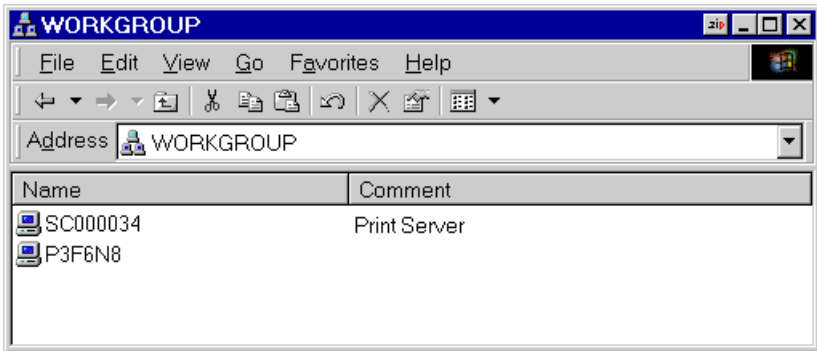

Figure 14: Network Neighborhood

4. Double-click the Print Server icon to view a Printer icon for each printer port. The "Comment" field may indicate what type of printer is connected to the port.
5. To install a printer, right-click the desired printer icon, and choose "Install", as shown below. This will start the *Add Printer* wizard.

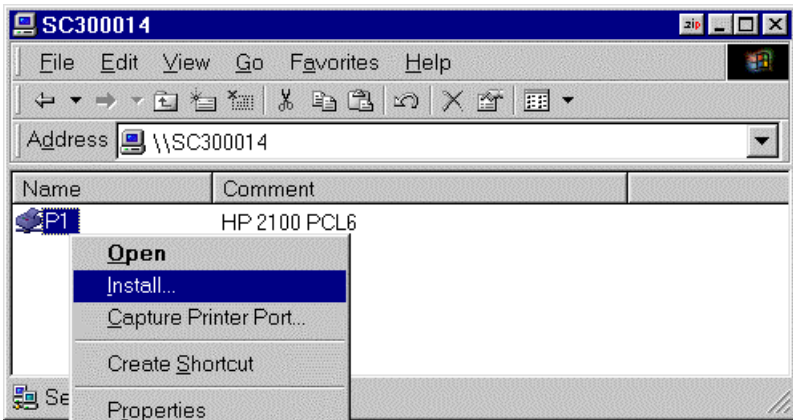

Figure 15: Install SMB Printer

6. Follow the prompts to complete the installation.
 - For information about the question "Do you print from MS-DOS programs?", see *Printing from MS-DOS Programs* below.
 - Select the Printer Manufacturer and Model to match the printer connected to this port on the Print Server, and complete the Wizard.
7. This printer will now appear in your *Printers* folder (*Start - Settings - Printers*) and can be used like any other printer. However, SMB printing is not suitable for large complex print jobs - you should use the *Peer-to-peer Printing* instead.

Printing from MS-DOS Programs

Windows can redirect print data from a parallel port on your PC (e.g. LPT1) to a network printer. This redirection is called "Capture Printer Port", and is useful for MS-DOS programs. The MS-DOS program is configured to use LPT1 (parallel port 1 on the PC), but Windows "captures" the print data and sends it to the network printer.

Capture Settings - Windows 98/ME

1. Select Start - Settings - Printers to open the **Printers** folder.
2. Right-click the desired Printer, and select *Properties*,

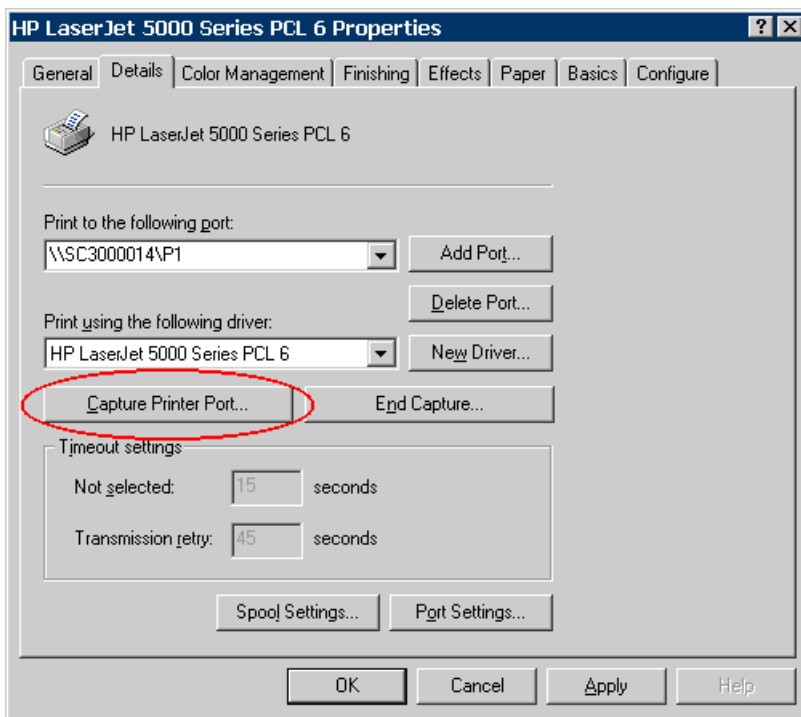

Figure 16: Capture Printer Port - Windows 98/ME

3. On the *Details* tab, shown above, click the *Capture Printer Port* button to view the *Capture Printer Port* dialog, as shown below.

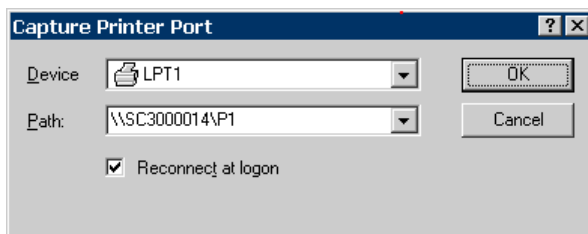

Figure 17: Capture Dialog - Windows 98/ME

4. On this dialog:
 - Select the Device (port) on the PC to be captured. Normally, this will be LPT1 (parallel port 1).
 - Enter or select the Path to the printer. This will be the same as the path shown as *Print to the following port* on the *Printer Properties* window.
 - Check the *Reconnect at logon* checkbox. If this is not done, the capture setting will be lost when Windows is restarted.

Capture Settings - Windows 2000/XP

1. Login as Administrator.
2. Open the command prompt window.
3. Enter the following command to capture data from LPT1 (parallel port 1)

```
net use lpt1 \\server_name\printer_name /persistent:yes
```

Where \\server_name\ printer_name is replaced with the actual path to your printer.

e.g.

```
net use lpt1 \\SC3000014\P1 /persistent:yes
```

4. Close the command prompt window.

To terminate this capture, use the following command at the command prompt:

```
net use lpt1 /delete
```

Windows with Server-based Print Queues

With a Server-based Print Queue, the Print Server is installed on an existing Network Server (Windows, Unix, or NetWare), rather than on your PC. If your Network Administrator uses this system, each Windows client must be set up as follows:

1. Open your *Printers* folder, and start the *Add Printer Wizard*.
2. When prompted, select *Network Printer*.
3. When prompted for *Network Path or Queue Name*:
 - On Windows 98/ME, click the *Browse* button
 - On Windows 2000/XP, leave the field blank and click *Next*

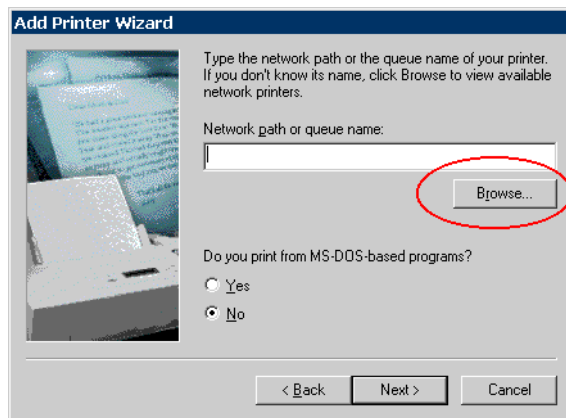

Figure 18: Network Path - Windows 98/ME

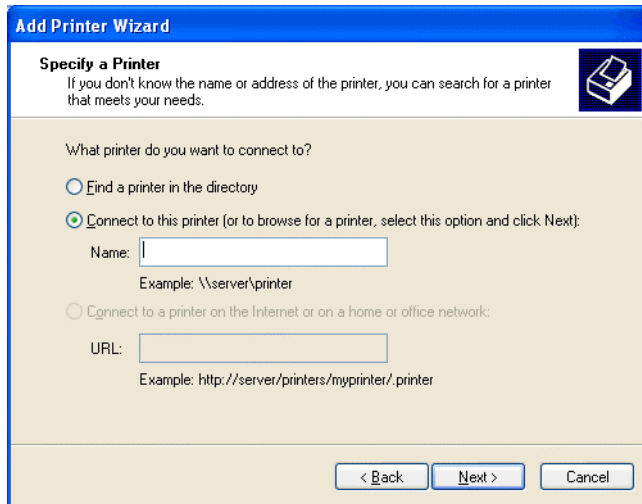

Figure 19: Network Path - Windows XP

4. Browse the network, and locate the Server and Printer (or Print Queue) which your Network Administrator advised you to use.
5. Click OK, then *Next*.
6. Select the correct printer Manufacturer and Model, as advised by your Network Administrator, and click *Next*.
7. Follow the prompts to complete the Wizard.

The new printer will be listed with any other installed printers, and may be selected when printing from any Windows application.

Macintosh (AppleTalk)

The Print Server supports AppleTalk (EtherTalk), PAP, ATP, NBP, ZIP and DDP protocols, enabling Macintosh computers on the network to view and use the Print Server as a regular AppleTalk printer.

Normally, no configuration is required.

Software Requirements

System 9.x OS or newer.

AppleTalk Setup

1. Click the apple icon and choose *Control Panel - AppleTalk*.
2. Ensure that *Ethernet* is selected under *AppleTalk Connection*.
3. Click *Chooser*. The Chooser panel will open.
4. Click on either the *LaserWriter 8* icon (recommended) or the *LaserWriter 7* icon. LaserWriter 8 makes use of the fonts installed in the printer itself, so the printing response time is quicker. LaserWriter 7 uses the fonts installed in the computer, which increases network traffic and takes more printing time.
5. Choose a PostScript printer from the list.
6. Click *Create* and it will search PPD automatically.
7. Select a printer description from the list.

8. Click *Select*.
Configuration is now complete.

Printing

Printing with the Print Server installed in an AppleTalk network is identical to normal printing. Just select *File - Print* and choose the desired printer.

Advanced Setup and Management

In a mixed Windows PC/Macintosh environment, you can use BiAdmin to configure the Print Server. See Chapter 5 for details on installing and using BiAdmin.

Macintosh OS X

If using LPR printing, you need to ensure the Print Server has a valid IP address before configuring your Mac as follows.

LPR printing Setup

1. Select the *Printer List* icon.

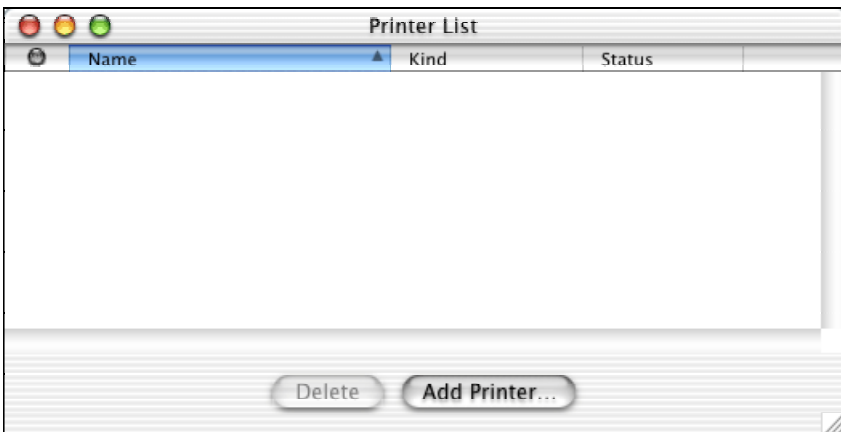

Figure 20: Printer List

2. Click the *Add Printer* button.
3. Choose *LPR Printers Using IP*.

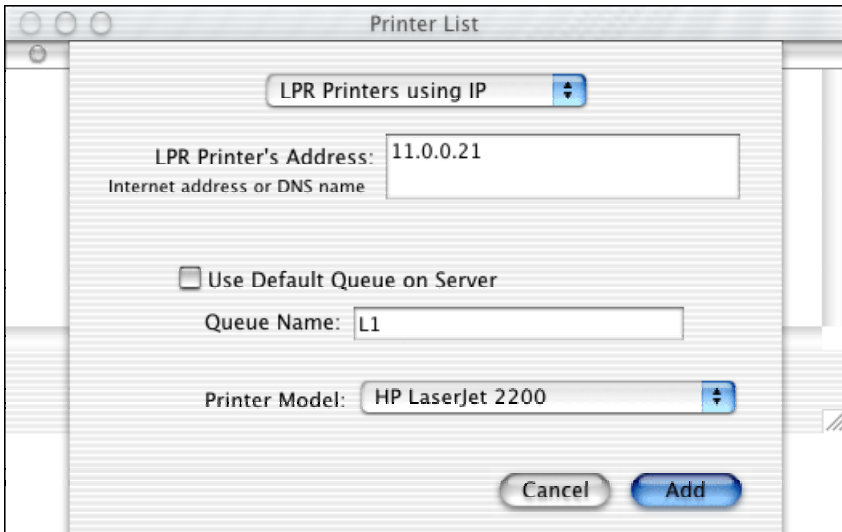

Figure 21: LPR Screen

4. Enter the IP address of the Print Server in the *LPR Printer's Address* field, and enter the *Queue Name* (e.g. L1).
5. Select the *Printer Model* from the drop-down list.
6. Click *Add*.
Configuration is now complete.

Chapter 5

BiAdmin Management Utility

This chapter describes the installation and operation of the BiAdmin Configuration & Management program.

Requirements

This program requires:

- Windows 95, Windows 98 or ME
- Windows NT 4.0, Windows 2000 or XP

Additional Recommendations:

- Screen resolution of 800 * 600 or greater.

Installation

Use the supplied CD-ROM. This CD-ROM will usually auto-run. If auto-run is disabled on your PC, run the SETUP.exe program in the root folder.

- Select **Installation** and this will give you the options for BiAdmin installation
 - BiAdmin is always installed if the **Administrator** option is chosen.
 - If using the **Custom** option on the CD-ROM, select **BiAdmin**.

Operation

- Start the program by using the icon created by the setup program.
- When run, the program searches the network for all active Print Servers, then lists them on screen, as shown by the example screen below.

Main Screen

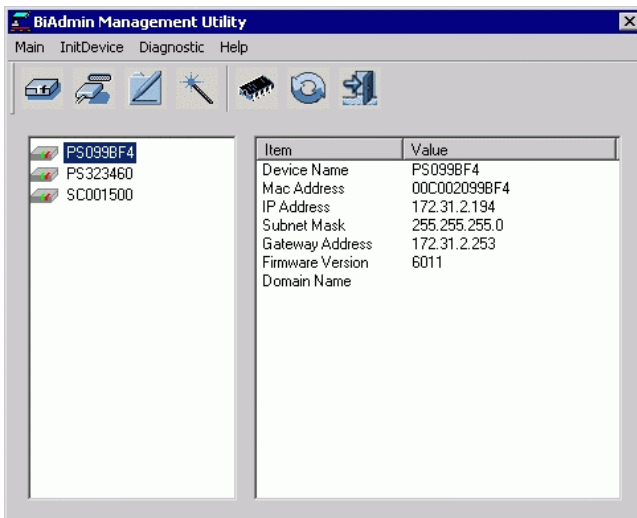

Figure 22: BiAdmin Main Screen

Device List

The left panel displays a list of all Print Servers found on the network. When a Print Server is selected from the list, its details are displayed in the right panel.

Note: If the IP address is "Null", please click the *Refresh* icon to get the value again.

If the desired Print Server is not listed, try the following:

- Check that the device is installed and ON, then *Refresh* the list.
- If the Print Server is on another LAN segment, use the *InitDevice - Attached Remote* menu option to locate and display the Print Server.

Icons



Device Status

Menu equivalent: *Main - Device Status*

All of the settings for the current device are displayed in a read-only scrollable list in the left panel.

You can use the "Save to File" and "Restore to Device" buttons on this screen to save a copy of the selected device's CONFIG file to your PC, or restore a previously saved file to the selected Print Server.

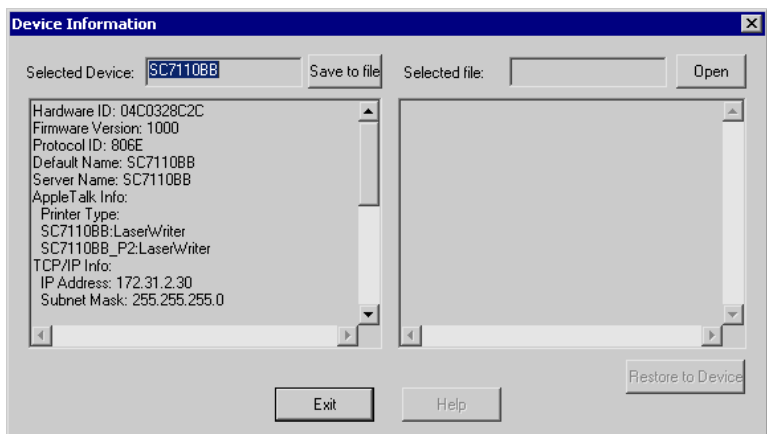

Printer Status

Menu equivalent: *Main - Printer Status*

After selecting this icon, a *Detail* button will be available to show more information about the printer.

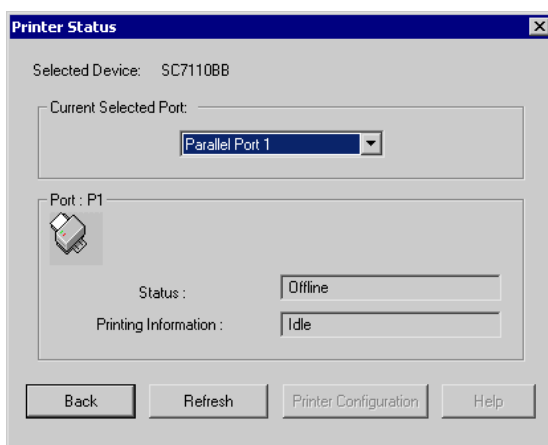

Select the desired port from the drop-down list to display the current status of the printer attached to the port. Possible states are:

- **Status** - On-line, Off-line, or Out of Paper
- **Printing Information** - Idle, Printing

If the printer is Bi-directional, and is not busy, the **Configuration** button will be available, allowing you to change the configuration of the attached printer. This button will be grayed out if the printer does not support this option, or if the printer is busy printing.



Configuration

Menu Equivalent: *Main - Configure*

This option allows you to configure the selected Print Server. See the following section for details.



Wizard

This Print Server Wizard allows you to do the basic configuration for the selected device. The screens are similar to the Wizard run from the CD-ROM, as described in Chapter 3.



Upgrade

Menu Equivalent: *Main - Upgrade*

This option allows you to upgrade the firmware for the selected Print Server. Before using this option, you need to obtain the .BIN file for the firmware upgrade, and copy it to the same directory as BiAdmin.



Refresh

Menu Equivalent: *Main - Refresh*

Select this icon to update the Print Server device listing after changing the name or IP Address.



Exit

Menu Equivalent: *Main - Exit*

Exit the BiAdmin program. This does not save any changes you have made; you must *Save to Device* on each screen.

Menus

Main Menu

Device Status	Same as <i>Device</i> Icon.
Printer Status	Same as <i>Printer Status</i> Icon.
Configure	Same as <i>Configure</i> Icon.
Upgrade	Same as <i>Upgrade</i> Icon.
Refresh	Same as <i>Refresh</i> Icon.
Exit	Same as <i>Exit</i> Icon.

InitDevice Menu

Reset Device	This will cause the device to reboot. This should be done after making any configuration changes, or if the device stops responding after some problems.
Restore to Factory Default	This will restore ALL device values to their factory defaults. To restore only the current screen, use the <i>Set to Default</i> button on the screen.
Attached Remote	This is used to connect to a Print Server device on another LAN segment. You need to know the IP address of the remote Print Server. If your LAN does not have a Router, you can ignore this option.
Connected Protocol	This option allows you to designate which LAN protocol will be used for communication between the selected device and this application. You should select ONE protocol only.

Diagnostics menu

Print Test Page	Use this option to print a test sheet from the selected Print Server port. The test print out will include status information.
------------------------	--

Configuration

When the *Configuration* icon is clicked, or the *Configure* option on the **Main** menu is selected, a tabbed window will open. The tabs available will vary depending on the Print Server model selected. The possible tabs are:

- System
- TCP/IP
- AppleTalk
- NetBEUI
- Internet Printing
- Port

System Tab

This screen allows you to:

- Change the name of the Print Server.
- Change the "Password" for the Print Server.
- Set the Network Protocols used the selected Print Server. (Any protocols not used on your LAN may be disabled. This may improve performance.)

The screenshot shows a configuration window for a print server. At the top, it displays "Selected Device: SC7110BB". Below this is a "Device Name:" field containing "SC7110BB". A "Device Password" section contains a checkbox for "Changed Device Password:" which is unchecked, and two empty text boxes for "Password:" and "Confirm Password:". A "Protocol" section lists four protocols with radio buttons for "Enable" and "Disable": TCP/IP (Enable selected), AppleTalk (Enable selected), NetBEUI (Enable selected), and IPX/SPX (Disable selected). A "Get Defaults" button is located at the bottom right.

Figure 23: System Screen

TCP/IP Tab

Selecting this tab will allow configuration for the TCP/IP network protocol. The basic options are:

- **Dynamic IP Address (DHCP)** - The IP address is obtained automatically, from a DHCP Server on your network.
- **Fixed IP Address** - You must enter the IP address, Subnet Mask, and Gateway Address.
 - *IP Address* - Select an unused IP address from the address range used on your LAN.
 - *Subnet Mask* - Use the same values as PCs on your LAN (or on the same LAN segment, if you have a Router).
 - *Gateway* - Use the same values as PCs on your LAN (or on the same LAN segment, if you have a Router).

Some Print Server models also support the Auto-IP function. If the Print Server is set to *Dynamic IP Address*, but there's no DHCP server found on the network, the Print Server will get an IP from the range of 169.254.1.1 ~ 169.254.254.254 automatically. In this case, even though the Print Server was initialized with an Auto-IP, it will change to DHCP whenever a DHCP server is detected.

Selected Device: SC7110BB

Dynamic IP Address (DHCP)

Fixed IP Address

IP Address: [0] [0] [0] [0]

Subnet Mask: [0] [0] [0] [0]

Gateway Address: [0] [0] [0] [0]

TCP session

Retry interval: [2] (sec.)

Retry count: [254]

Get Defaults

Figure 24: TCP/IP Screen

The *TCP session* parameters should only be changed if advised to do so by your Network Administrator or Print Server Technical Support.

AppleTalk Tab

Generally, no Print Server configuration is required in order to use AppleTalk.

This screen allows you to:

- Set the *Zone Name* field to determine which Apple systems can gain access to this printer.
- The *Printer Type* field is used to describe the printer driver used for each port.
- Set *Communication Protocol* to ASCII or Binary. This must match the setting on the Apple computer systems using the Print Server.

Selected Device: SC7110BB

Zone Name:

Port Setting

Selected Port:

Printer Type:

Communication Protocol: ASCII Binary

Figure 25: AppleTalk Screen

NetBEUI Tab

This screen allows you to:

- Choose the *Domain name* for the selected Print Server.
- Set how fast jobs are sent to the printer by using the *Response Time* field.
- Set the desired option for the *Abort Job if Error Occured* setting.
 - YES causes a print job to be terminated if a printing error occurs.
 - NO (default) will try to continue but may cause print errors.



The screenshot shows a configuration window with the following elements:

- Selected Device:** SC7110BB
- Domain Name:** A dropdown menu with "RD" selected.
- Port Setting:** A sub-section containing:
 - Response Time:** A text input field with "0" and a range "(0~255, 0.1 sec/unit)".
 - Abort Job if Error Occured:** Two radio buttons, "Yes" (unselected) and "No" (selected).
- Get Defaults:** A button located at the bottom right of the window.

Figure 26: NetBEUI Screen

Internet Printing Tab

The Internet Printing feature available on some models, allows you to send print jobs to the Print Server using Internet E-mail.

Please see *Chapter 7 - Special Features* for details of using this feature.

Selected Device: SC7110BB

Mail Server

Mail Server IP Address: 0 0 0 0

Mail Account:

Password: Confirm Password:

Check Mail Interval: 0 : 1 (hh : mm)

Redirect Mail Account:

Mail Server

Default Printer Port: P1

Printer Model:

Options

Print Every Mail Banner Printing Mail Response when Printed

Get Defaults

Figure 27: Internet Printing Screen

Port Tab

This screen has 2 panels - *Physical Port* and *Logical Port*.

Physical Port

The following settings are available:

- **Selected Physical Port** - Select the Physical Printer Port you wish to configure.
- **Handshake Signal** - Select *Busy Only* or *Busy & Ack* for the Physical Port.
- **Printer Type** - Select *High Speed* or *Low Speed* for the Printer Type.

Logical Port

Logical Ports (printers) can be used in the Unix environment. The following settings are available:

- **Selected Logical Port** - Select the Logical Printer Port you wish to configure.
- **Map to Physical Port** - Select the physical Printer Port which the Logical printer will use.
- **Convert LF to LF+CR** - If checked, LF (line feed) characters are changed to CR+LF (carriage return + line feed).
- **Prefix of Job** - The printer control string (**in hex**) to be sent to the printer before each print job. This string cannot exceed 15 characters.
- **Suffix of Job** - The printer control string (**in hex**) to be sent to the printer after each print job. This string cannot exceed 15 characters.

The screenshot shows a configuration window titled "Port Tab" with a "Selected Device" of "SC7110BB". It is divided into two main sections: "Physical Port" and "Logical Port".

Physical Port Section:

- Selected Physical Port: A dropdown menu showing "P1".
- Handshake Signal: Two radio buttons, "Busy Only" (selected) and "Busy & Ack".
- Printer Type: Two radio buttons, "High Speed" and "Low Speed" (selected).

Logical Port Section:

- Selected Logical Port: A dropdown menu showing "Logical Port 1".
- Map to Physical Port: A dropdown menu showing "P1".
- Convert LF to LF+CR: Two radio buttons, "No" (selected) and "Yes".
- Prefix of Job: An empty text input field.
- Suffix of Job: An empty text input field.

A "Get Defaults" button is located at the bottom right of the window.

Figure 28: Port Screen

The *Get Defaults* button will reset all settings to their factory-default values.

Chapter 6

Web-Based Management

This chapter explains how to use your Web Browser to configure the Print Server

Overview

The Print Server incorporate the HTTP server. This allows you to connect to the Print Server and configure it using your Web Browser. Most browsers should work, provided they support tables and forms.

Preparation

Because it supports dynamic IP Address allocation using DHCP, BOOTP, or RARP, the Print Server ships with an IP Address of 0.0.0.0. This is NOT a valid IP Address.

Therefore, you must do ONE of the following:

- Check your **DHCP server** (if you have one), and determine the IP Address allocated to the Print Server.
- Use the **Setup Wizard**, **BiAdmin** or another Print Server utility to allocate a valid IP Address to the Print Server.
- Add an entry to the **arp** table to associate the hardware address of the Print Server with the desired IP address, as follows:

```
arp -s IP_Address 00:c0:02:xx:xx:xx (Unix)
```

```
arp -s IP_Address 00-c0-02-xx-xx-xx (Windows)
```

Where:

IP_Address is the IP Address you wish to assign to the Print Server.

00:c0:02:xx:xx:xx is the hardware address of the Print Server.

Example (Unix):

```
arp -s 192.168.0.21 00:c0:02:12:34:56
```

Example (Windows):

```
arp -s 192.168.0.21 00-c0-02-12-34-56
```

Note: The hardware address of the Print Server is shown on a sticker on the base of the device.

Connecting to the Print Server

1. Start your Web Browser.
2. In the *Address* box, enter *HTTP://* followed by the IP Address of the Print Server.
e.g.
`http://192.168.0.21`
3. You will then be prompted for the password. If no password has been set, just press ENTER.
4. Use the menu bar on the top of the screen to move about. Remember to save each screen before changing to a different screen.

Configuration Screens

Depending on your models, the Web-based interface may look different to the images shown in the User's Manual. The functions have not changed, and the description of each setting is correct. Only the appearances are different.

AppleTalk

Figure 29: AppleTalk Screen

AppleTalk zone	This determines which Apple systems can gain access to this printer.
Printer Object Type	These are text fields, used to describe the printer driver used for each port. The Print Server is designed to work with LaserWriter (or 100% compatible) printers.
Communication Protocol	Sets whether the port uses ASCII or Binary Communication Protocol.. The default is Binary.

NetBEUI

Workgroup

Response Time (0.1 secs): 0 (0..255)

Abort Print Job if Error: Yes
 No

Save Cancel

Figure 30: NetBEUI Screen

Domain Name	Enter the designated work group to be serviced by the Print Server. This field is not case sensitive, so names with different case will be considered to be the same name.
Response Time	Set how fast jobs are sent to the printer. The default value of zero (0) delay should be increased only if your printer cannot cope with no delays.
Abort Job if Error	YES terminates a print job if a printing error occurs. NO (default) will try to continue but may cause print errors. If print errors occur, try setting this value to YES.

TCP/IP

IP Address: DHCP Client
 Fixed IP Address:

IP Address	192	168	0	100
Subnet Mask	255	255	255	0
Gateway Address	0	0	0	0

Delay before reconnection attempt (secs) (0..255)
Number of reconnection attempts (0..255)

Figure 31: TCP/IP Screen

IP Address	IP Address assigned to this device. If using dynamic IP Addresses (DHCP, BOOTP, rarp), this should be left at 0.0.0.0.
Subnet Mask (Network Mask)	If the Router (Gateway) Address is 0.0.0.0, the Subnet Mask should also be left at 0.0.0.0. If you have a router, enter the Subnet mask for the segment to which the Print Server is attached.
Gateway Address	If your network segment has a router or gateways, enter its IP Address here. Otherwise, leave the address as 0.0.0.0.
Connection	
Delay before reconnection attempts	Sets how long the Print Server should wait before retrying a TCP/IP connection which is lost. Allowable values are from 0 to 255 seconds, with 2 as the default.
Number of reconnection attempts	Set how many attempts at reconnection will be made. After that, the TCP/IP session will be terminated. Allowable values are from 0 to 255, with 254 as the default.

Configure Server

Print Server Name: AdminLaser

Device Password: xoxox

Verify Password: xoxox

Enable: Appletalk
 NetBEUI

Save Cancel

Figure 32: Configure Server Screen

Print Server Name	Change the default name if you wish. The new name must not contain any spaces or blanks.
Password	Enter the device password, and again in the <i>Verify</i> field. Once a password is entered, it is required in order to gain access and change the configuration.
Enable Protocols	Non-TCP/IP may be disabled if they are not required on your LAN. The available protocols depend on the Print Server model.

Other Screens

Server Status

This screen shows server system data and the current settings for all of the other screens. It is read-only; no data can be input on this screen.

Printer Ports

This screen displays the current status of each port. For each port, the following data is listed:

- **Connected Printer**- the model name of the printer connected to the port, if the printer name is known. (If the printer is not bi-directional, this information is unavailable.)
- **Status** - the current status of the printer (On-line, Off-line, Out of paper)
- **Printing Information** - this will show either *Idle* or *Printing*.

Logical Printers

Logical Printers (ports) can be used under Unix. For each Logical Printer, the following fields are available:

Logical Printer (Port)	Select the Logical Printer Port you wish to configure. (e.g. L1) Click the Get Data button to update the display with the current data for the selected logical printer.
Port	Select the Printer Port which the Logical printer will use.
Pre-string	The printer control string (in hex) to be sent to the printer before each print job. This string cannot exceed 15 characters.
Post String	The printer control string (in hex) to be sent to the printer after each print job. This string cannot exceed 15 characters.
Convert LF to CR+LF	If checked, LF (line feed) characters are changed to CR+LF (carriage return + line feed).

Internet Printing

See *Chapter 7 - Special Features* for details of this feature.

Chapter 7

Special Features

This chapter covers the special features of the Print Server.

Overview

The Print Server has 2 special features:

- IPP (Internet Printing Protocol).
- Proprietary *Internet Mail Printing* system.

Internet Printing Protocol(IPP)

IPP (Internet Printing Protocol) is a standards-based system to allow remote printing from a PC to any accessible printer. Normally, the printer will be attached to a computer or other device which functions as an **IPP Server**.

Client PCs need a compatible **IPP Client** program. Windows 2000 and XP include a suitable IPP client. For other versions of Windows, a client program is supplied on the Print Server's CD-ROM.

The Client must also know the IP Address or URL of the IPP Server.

IPP Server Configuration

The Print Server contains the necessary firmware to act as an **IPP Server**. No additional configuration is necessary. However, the following requirements must be met.

- The Print Server must have a valid IP Address. For printing via the Internet, the Print Server's IP Address must be external (allocated by your ISP), rather than an IP Address on your local LAN.
- Any Router, Gateway or Firewall linking your LAN to the Internet must NOT block the IPP protocol.
- You must advise clients of the correct URL or IP Address of the IPP Server. To use a URL rather than an IP Address, you need to register the domain name for the URL.
- Unless clients are using Windows 2000 or XP, you must provide your clients with the supplied IPP Client software. If it is not convenient to provide the CD-ROM, supply the IPP_CLIENT.EXE file, located in the IPP folder.

IPP Client Setup - Windows 98/ME

For these platforms, IPP Client software is supplied on the CD-ROM.

Also you can distribute the setup program (IPP_CLIENT.EXE) to users via E-mail.

Installing from the CD-ROM

1. Insert the CD-ROM in your drive. If the program does not start automatically, run the SETUP program in the top-level folder.
2. Follow the prompts until you reach the *Select Installation* screen, and select *IPP Client*.
3. At the next screen, select the *Install IPP Client* option.
4. Click *Next*, and step through the remaining screens to complete the installation.

Installing using IPP_CLIENT.EXE

1. Run this program to unzip the included files.
2. The IPP Setup program will then run.
3. Follow the prompts to complete the installation.

IPP Client Configuration

1. Run the "Add IPP Port" program entry created by the installation. A screen like the following will be displayed.

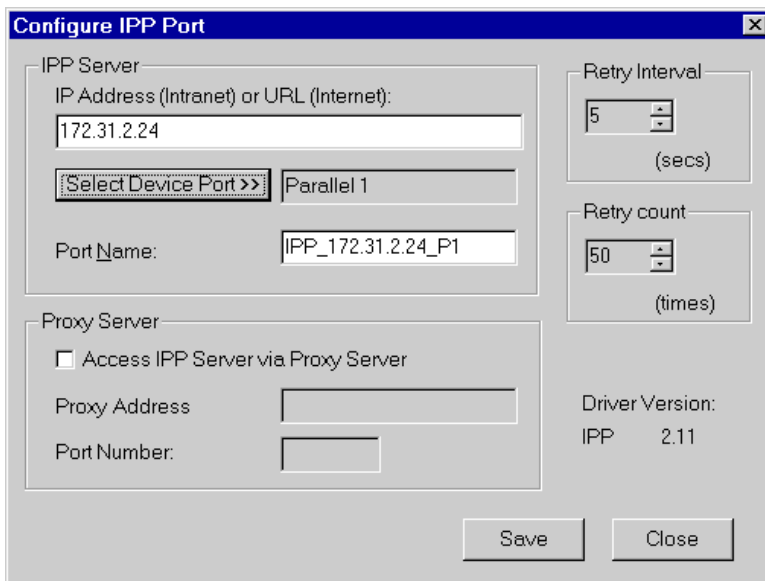

Figure 33: IPP Port

2. If Internet access from your location is via a Proxy Server, check *Access IPP Server via Proxy Server*, and enter details of your Proxy Server. (This will be the same as your Browser configuration.)
3. Enter the IP Address or URL of the IPP Server.
4. Click *Select Device Port* to view the available ports on the IPP Server, and select the appropriate port. A connection to the IPP Server will be established at this time.
5. Click *Save* to create the IPP port on your system. You will see a message confirming that the port has been created, then the following dialog:

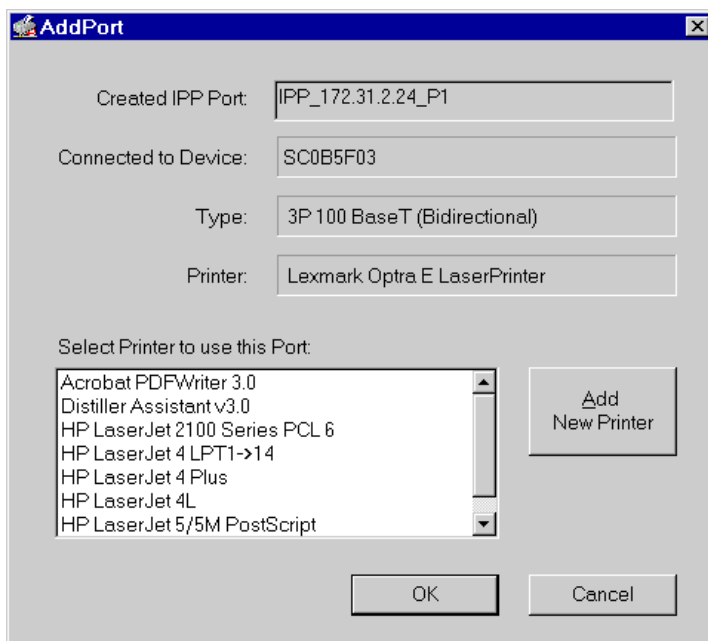

Figure 34: Select Printer for IPP Port

6. Either select an existing printer to use the new port, and click OK.

OR

Click the *Add New Printer* button to create a new printer to use the IPP port. This will start the *Add Printer* wizard. Follow the prompts to complete the process. Ensure that the new printer uses the IPP port.

Installation is now complete.

- To create additional IPP Ports, repeat the entire procedure.
- The Proxy Server and other options are set individually for each IPP Port.

Changing the IPP Port Settings

After the IPP port is created, you can reach the screen shown in *Figure 33: IPP Port* using the Windows *Port Settings* button:

1. Open the *Printers* folder (*Start - Settings - Printers*)
2. Right-click the IPP Printer, and select *Properties*.
3. Locate and click the *Port Settings* button (*Details* or *Port* tab, depending on your version of Windows).

There are 2 settings - *Retry Interval* and *Retry Count* - which can be adjusted if you have problems connecting to the IPP Server.

- **Retry Interval** sets the time interval (in seconds) between connection attempts. Increase this number if you have a poor connection, or the remote server is very busy.
- **Retry Count** sets how many connection attempts will be made. Increase this number if you have a poor connection, or the remote server is very busy.

IPP Client Setup - Windows 2000/XP

Windows 2000 and XP have their own IPP Client, and there is no need to install the supplied IPP Client Software. To use the Windows IPP Client with the Print Server, follow this procedure:

1. Start the *Add Printer* wizard.
2. Select *Network Printer*, and click "Next" to see the *Locate your Printer* screen, as shown below.

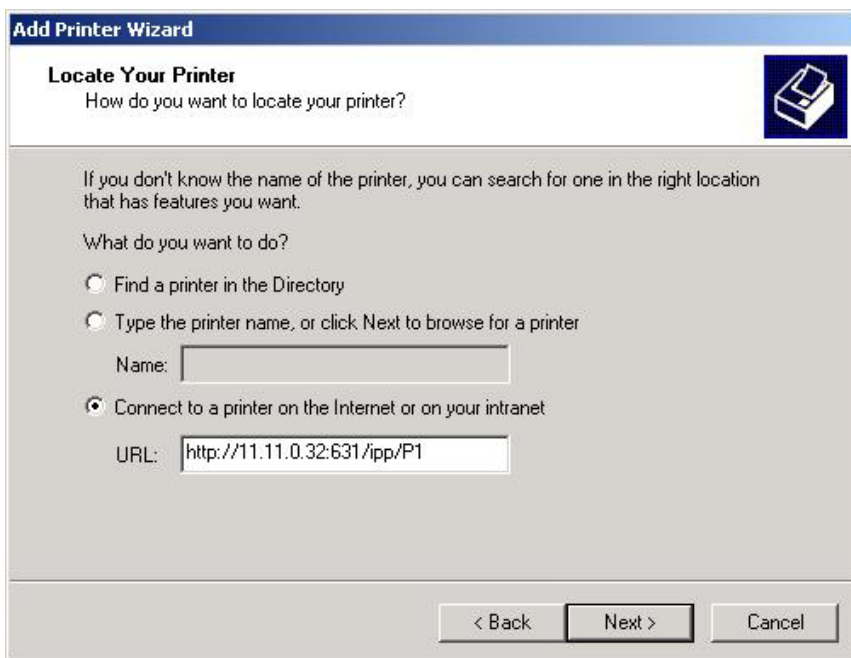

Figure 35: Windows 2000 - Locate your Printer

3. Select *Connect to a printer on the Internet or on your Intranet*, and enter the URL of the IPP Server as follows, where *ip_address* represents the IP Address of the IPP Server, and 631 is the port number.

Port 1 *ip_address*:631/ipp/P1

Port 2 (if exists) *ip_address*:631/ipp/P2



Note!

These entries are case sensitive. They must be entered as shown, with "ipp" in lower case, and P1 and P2 in UPPER case.

4. If the connection can be established, and the printer on that port is on-line, the following dialog will be displayed.

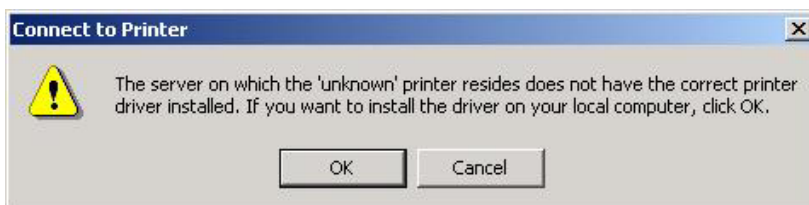

Figure 36: Windows 2000: No printer driver

5. Click "OK", and then select the printer manufacturer and model to match the printer connected to the port on the IPP Server.
6. Click "Next", and complete the Wizard.
The IPP printer is now ready for use.

Using IPP Printers

The IPP Printer can be selected and used like any other Windows printer. If the IPP Server is not on your network, your Internet connection needs to be active.

If using the supplied IPP Client software, you can use the *Query IPP Printer* program installed with *Add IPP Port* to check the availability of the remote IPP Server.

An IPP Server may be unavailable for any of the following reasons:

- It is powered off.
- A printer problem has caused the IPP Server to cease responding, and a restart (reboot) is required.
- The Server's IP Address has changed.
- The Internet connection for the IPP Server is down.
- Network congestion causes the connection attempt to time out.

If using the supplied IPP Client software, there are 2 settings - *Retry Interval* and *Retry Count* - which can be adjusted if you have problems connecting to the IPP Server.

See the previous section *Changing the IPP Port Settings* for details.

Internet Mail Printing

The Internet Mail Printing System allows users to print data to your printer across the Internet. Users send the Internet Print Server an E-Mail, with the print job normally sent as an attachment to the E-Mail. The Print Server will retrieve the E-Mail and print it.

System Requirements

Mail Server

- **Accessibility.** The Mail Server must be accessible by the intended clients or users. Normally, this means a permanent connection to the Internet.
- **Protocols.** The Mail Server must support the POP3 and SMTP protocols. The Internet Printing System uses these protocols and the most common E-Mail formatting standards:
 - MIME (Multipurpose Internet Mail Extensions)
 - Base64 Encoding (for mail attachments)

Internet Print Server

- **TCP/IP Protocol.** The LAN must use the TCP/IP protocol.
- **Mail Server Access.** The Print Server must be able to access the Mail Server using a single IP address.
- **Mail Account.** The Print Server must have a Mail Account. Users print by sending an E-Mail to this mail account.

User (Client) Requirements

- **Internet Connection.** Either through a LAN, or dial-up.
- **E-Mail address.** This is used to notify the user that their print job has been done, or if there are any problems.
- **Printer Driver.** Users must have a printer driver which matches the printer connected to the remote Internet Print Server.
- **Print Capture Software.** To print more than plain text, users require InterNet Printing Port software to capture the print job and convert it into an E-Mail attachment. The Internet Printing Port software is available for the following operating systems:
 - Microsoft Windows 95, 98, or ME
 - Microsoft Windows NT 4.0, Windows 2000, Windows XP.

Internet Mail Printing Configuration

The Print Server must be configured with the data in the following table.

The supplied **BiAdmin** utility program, or the Web interface (on 100BaseT models) can be used to set the following entries on the TCP/IP screen.

Mail Server IP Address	The IP Address of the E-Mail Server used by the Print Server.
Mail Account	The name of the E-Mail Account used by the Print Server.
Mail Account Password	Enter the password for the above Mail Account here.
Check Mail Interval	Sets how often to check for mail.
Redirect Mail Account	Jobs which can not be printed will be sent to this account. If blank, unprintable jobs will be discarded.
Default Printer Port	Printer number for all Internet print jobs. Only one port can be selected. Users on the LAN can also use this port.
Printer Model	This text field identifies the printer used for Internet printing. This value is sent to remote users upon request.
Print every E-Mail	If ON, then all E-Mail received is printed. Otherwise, only E-Mail from the InterNet Printing Port will be printed.
Print Banner	If YES (default), a banner page is printed to identify the owner of the print job.
Mail Response when Printed	If YES, all print jobs receive an E-Mail response. If NO, only users who set this option in their InterNet Printing Port software receive an E-Mail.

User Software

The software provided for remote users (InterNet Printing Port) should be installed by everyone intending to use Internet printing. Otherwise, remote users can print correctly only if:

- They send an E-Mail directly to the Print Server Mail Account, using their normal E-Mail application.
- The E-Mail contains plain text only.
- The Internet Print Server is configured with *Print every E-Mail ON*.

Installation of the InterNet Printing Port software will create a new printer port. After attaching the correct printer to this port, users can print to the Internet Printer using any Windows application.

Installation - User Software

1. Run the InterNet Printing Port installation program SETUP.EXE
2. Default values for the installation are:
 - **Directory** - C:\Program Files\Internet_Printer
 - **Start Menu folder** - InterNet Printing Port Driver
3. You will then see the *Configure Port* screen, as shown in the following screenshot.

InterNet Printing Port Driver Configuration (ver 1.0)

Port Name :

Remote Printer

E-mail address

Your E-mail information

Mail Server Name or IP Address

Your Internet E-mail address (e.g. username@company.com)

Retry Interval: Sec.

Reply Notification E-mail

OK
Cancel
Help

Figure 37: InterNet Printer Port

4. The following data must be provided.

Port Name	Enter a descriptive name (e.g. "WAN") for the new printer port.
------------------	---

Remote Printer E-mail Address	The E-Mail address for the Internet printer. Your print jobs will be sent to this E-Mail address.
Mail Server Name or IP Address	This is the name or IP Address of your Mail Server. If you are on a LAN, ask the LAN Administrator. If using a dial-up connection, use the data provided by your ISP.
Your Internet E-mail Address	The normal address that people use to send you E-mail.
Retry Interval (Seconds)	If unable to connect to the E-Mail server, retry after this time period (1 to 255 seconds, 30 is usually OK).
Reply Notification Mail	Check to receive an E-Mail when your print job has been processed.

5. On completion, a new printer port will have been created.

Using the new Port

The Windows Control Panel is used to connect the correct printer to the InterNet Printing Port. In Windows 95/NT, the procedure is:

1. Select the Printer which matches the remote printer, then choose *Properties*, as shown in the example below.

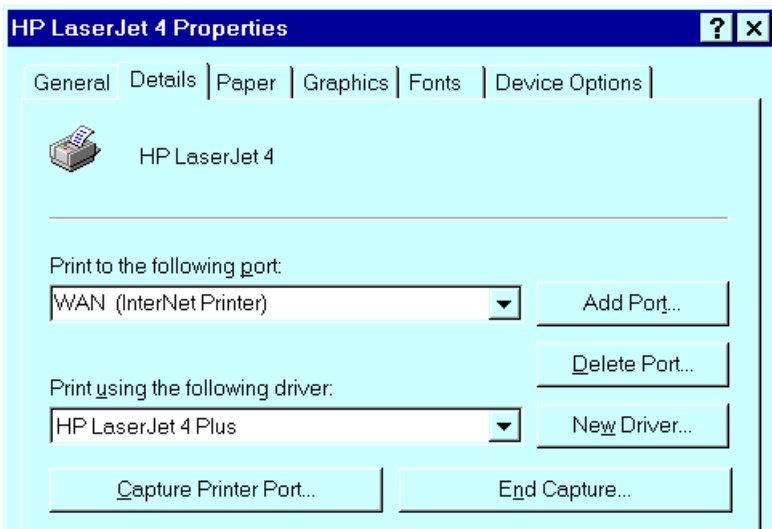

Figure 38: InterNet Printer Properties

2. Select the new port - WAN (InterNet Printer) in the example - as the port for this printer.
 - If you do not have the correct printer driver, or you wish to create another printer using an existing driver, use the Windows *Add Printer* facility.
 - Using the Windows *Port Settings* or *Configure Port* facility will reveal the same *Configure Port* screen shown in *Figure 37: InterNet Printer Port*.
 - If you wish to print to multiple Internet Printers, use the Windows *Add Port* facility to add a new InterNet Printer port. Ensure that the correct data is entered in each port, and that each port has a unique name.

Checking the Printer Driver

To make sure that the correct printer driver for the remote printer is installed on your system, you can use the InterNet Printing Port to send an E-Mail to the Internet Printer. The procedure is as follows:

1. Connect your default printer to the InterNet Printing Port.
2. Check that "Reply Notification Mail" in the InterNet Printing Port is ON.
3. From Notepad or another text editor, print a short message (e.g. "This is a test print") to the Internet Printer.

You will receive a reply E-Mail containing the "Printer ID" which will identify the printer attached to the Print Server. If this does not match the printer driver you are using, install the correct printer driver.

Printing through the internet

1. Create or open the document you wish to print.
2. Select the Printer connected to the InterNet Printing Port.
3. If you do not have a permanent Internet connection, establish a connection now. (**Note:** The InterNet Printing Port will NOT establish a dial-up connection, but it will send the E-Mail the next time you are connected.)
4. Print the document.
5. The InterNet Printing Port will generate an E-Mail and send it to the remote printer. The document will be encoded and sent as an attachment to the E-Mail. You will see a progress screen similar to the example below:

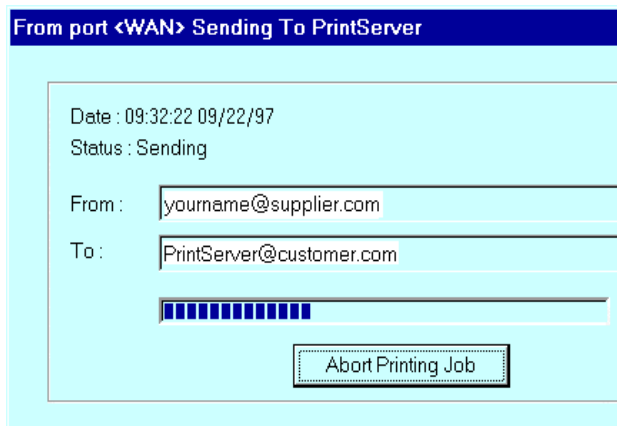

Figure 39 InterNet Printing Progress

6. Close the Internet connection if you opened it in Step 3.
7. If the "Notify after print job" option is set, you will receive an E-Mail when your job is printed.

Chapter 8

Troubleshooting

This chapter describes some problem situations, which may arise, and the solutions to them.

Overview

If you encounter printing difficulties, please refer to the appropriate section.

If, after following the advice in these documents, the Print Server still does not function properly, please contact your dealer for further advice.

Hardware & LAN Problems

Problem No. 1	All the Print Server's LEDs are off.
Solution No. 1	Check the power supply or power connection.
Problem No. 2	Print Server's status light continuously stays lit.
Solution No. 2	Reset the Print Server by unplugging the power supply and plugging it back in.
Problem No. 3	The Print Server unit can not be found on the LAN, so configuration is not possible.
Solution No. 3	<p>If using 10/100BaseT, check the Hub:</p> <ul style="list-style-type: none">• The link LED for the port to which the Print Server is connected should be ON.• If it is Off, there is a problem in the network cable. <p>If using TCP/IP:</p> <ul style="list-style-type: none">• Ensure that there are no routers between the Print Server and the PC used for configuration.• Ensure that the PC used for configuration has the TCP/IP network protocol installed. Test its network connection by seeing if you can locate other LAN devices from the PC. (e.g. Use <i>Network Neighborhood</i> and try to browse the network.)
Problem No. 4	I am using DHCP, and getting an IP Address conflict involving the Print Server.
Solution No. 4	<p>If the Print Server is left on, but the DHCP server is turned off, then the Print Server will retain its IP Address without the DHCP Server being aware of it. Simply reset the Print Server so it will obtain a new IP Address.</p> <p>This problem would also arise if you assigned static IP Address, which is within the range used by the DHCP server. If so, use another address which is NOT within the range used by the DHCP server.</p>

AppleTalk (Macintosh)

Problem No. 1	Why do I get an incorrect printout?
Solution No. 1	Some possible reasons are: <ul style="list-style-type: none">• You may have chosen Binary encoding to print the file. Try to use ASCII encoding.• Some of the fonts, which are in your print file may not be supported by the printer. Try selecting LaserWriter 7 instead of LaserWriter 8.
Problem No. 2	Can't find the Print Server's name in the Chooser.
Solution No. 2	Try the following: <ol style="list-style-type: none">1. Make sure that AppleTalk is on (the button next to Active is highlighted in the Chooser).2. Make sure the printer has been on and in the READY state for a few minutes.3. Make sure the printer has not been renamed since its last appearance in the Chooser.4. If the printer resides on a network with multiple zones, make sure the correct zone is selected from the AppleTalk Zones box in the Chooser.
Problem No. 3	My document didn't print to the right printer.
Solution No. 3	Check the following: <ul style="list-style-type: none">• Another Print Server with the same name may have received your print job. Use the PSTOOL to reconfigure your Print Server name and ensure all Print Servers have unique names.• Make sure your application output encode is set to ASCII. If not, change it to ASCII.
Problem No. 4	My file doesn't print with the correct fonts.
Solution No. 4	Try changing your printer driver to LaserWriter 7.
Problem No. 5	My EPS file doesn't print with the correct fonts.
Solution No. 5	This is a problem that occurs in some application programs. Try downloading the fonts contained in the EPS file before printing the saved EPS file.
Problem No. 6	I can't select the "Remaining from:" item in the print dialog box.
Solution No. 6	If you have selected the Layout value, "2 Up", or "4 Up", you cannot access the <i>Remaining from</i> item. Choose other selections.
Problem No. 7	A cover page prints either on the first or the last page of the document.
Solution No. 7	Select one of these solutions: <ul style="list-style-type: none">• Turn the cover page feature off.• Insert extra page breaks in your document to avoid the cover page printing on the first or last page of your document.• Install the Apple LaserWriter 7 driver. You are having trouble printing with the Apple LaserWriter 8 driver.

Problem No. 8	Why do I have trouble printing with the LaserWriter 8?
Solution No. 8	Your application software may not be compatible with the LaserWriter 8 driver or your system may not meet the requirements of the LaserWriter 8 driver. Use the Apple LaserWriter 7 driver instead.
Problem No. 9	The colors on my printed output do not match the colors on my computer screen.
Solution No. 9	<p>When the printer receives a color file, it tries to match the printed output color to the screen color. Sometimes the printer cannot match up the colors as closely as wanted. To alleviate this problem, perform the following steps:</p> <ul style="list-style-type: none"> • Choose "Calibrated Color/Grayscale" in the <i>Print</i> pop-up menu in the <i>Print Options</i> dialog box. The printer will make adjustments to match the colors. • Check your monitor to make sure all settings (for example, brightness) are adjusted correctly.
Problem No. 10	When I send a print job, I get a PostScript Command error or no print out.
Solution No. 10	<p>Check the communication protocols. The computer, Print Server and printer must all be configured to the same communication protocol.(either Binary or ASCII).</p> <p>To configure your system:</p> <ol style="list-style-type: none"> 1. Choose which protocol you are going to use. You should check your printer; it may not give you a choice. 2. Set your printer to the correct protocol. 3. Use the computer's <i>Print</i> submenu to configure your computer to use the protocol you have chosen. 4. Configure the Print Server to use the same protocol as the printer and computer.

Windows Printing Problems

Problem No. 1	When I tried to install the Printing software for Peer-to-Peer printing, I received an error message and the installation was aborted..
Solution No. 1	<p>This may be caused by an existing installation of the printer port software. Before attempting another installation:</p> <ul style="list-style-type: none">• Remove the existing installation• Restart your PC <p>To remove an existing printer port installation:</p> <ol style="list-style-type: none">1. Open <i>Start - Settings - Control Panel - Add/Remove Programs</i>2. Look for an entry with a name like "Shared Port", "Shared Printer Port", " Print Server Driver" or " Print Server Port".3. Select this item, click "Add/Remove", and confirm the deletion.
Problem No. 2	On Windows 95, I installed the Print Port Driver for Peer-to-Peer Printing, but when I selected a port on a Print Server and clicked "Add", the printer was not installed.
Solution No. 2	<p>Try installing the Printer using the standard Windows tools, as follows:</p> <ol style="list-style-type: none">1. Start the <i>Add Printer Wizard</i>.2. Select <i>Network Printer</i> when prompted "How is the printer attached to your Computer?", and click Next.3. When prompted for the Network Path or Queue, enter a dummy value such as shown below. (Do NOT select <i>Yes</i> for "Do you print for MS-DOS programs?") <div data-bbox="374 1085 1073 1596"></div> <ol style="list-style-type: none">4. The printer wizard will display a message stating that "The Network Printer is off-line". This is OK. Continue the Add Printer Wizard until finished.5. Go to the Printers folder (<i>Control Panel-Printers</i>). The printer icon will be grayed out indicating the printer is not ready.6. Right-click the Printer, and select <i>Properties</i>. Then select the <i>Details</i> tab, as shown below.

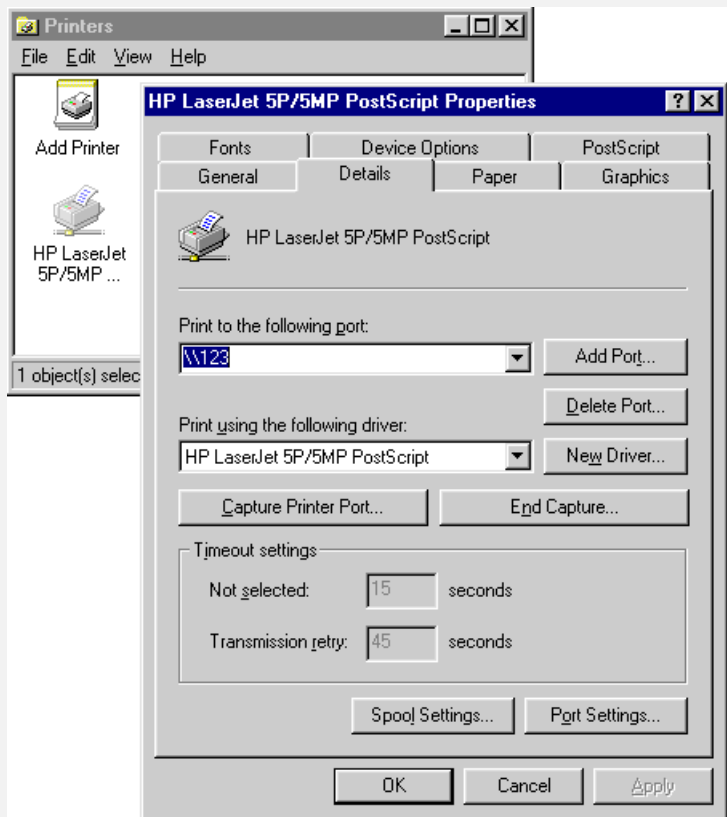

7. Click the *Add Port* button. On the resulting screen, select *Other*, then *Printer Server*, as the port to add, as shown below.

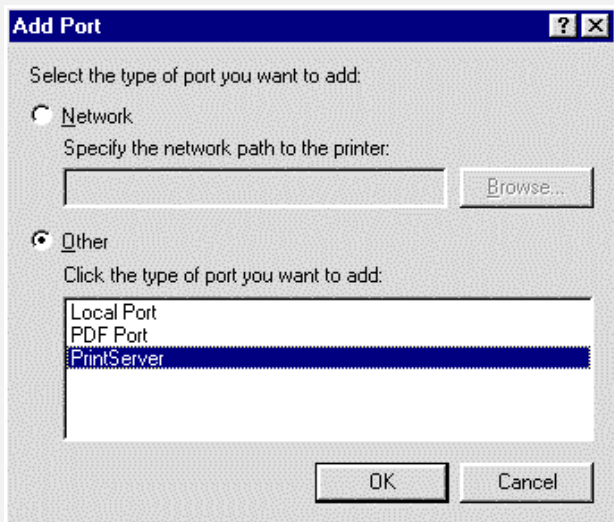

8. Click OK to see the *Print Port Configuration* screen, as shown below.

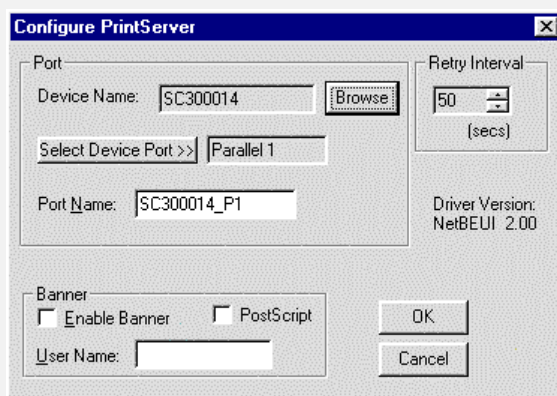

9. Click the *Browse Device* button, select the desired Print Server, and click OK.
10. Click OK to return to the Printers folders, and right-click on the Printer. Ensure that the *Work off-line* option is NOT checked.

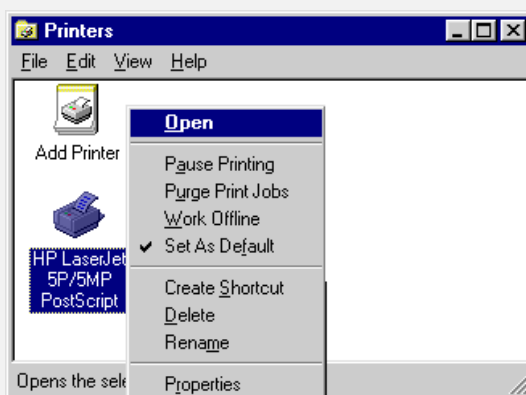

The Printer should no longer be grayed out, and is ready for use.

Problem No. 3

I can't get my Windows-only printer to work.

Solution No. 3

Many Windows-only printers cannot be networked, and so are not compatible with the Print Server.

You can try adding your printer as a network printer as described in Solution 2 above.

Problem No. 4

Using Windows 2000/XP, I installed the printer using LPD as recommended, but I can't print.

Solution No. 4

- Check that the correct Printer driver is being used.
- Try disabling the Bidirectional printing support:
 - Open the Printers folder.
 - Right-click on the Printer, and select *Properties*.
 - Select the *Ports* tab.
 - Uncheck the *Enable bidirectional support* checkbox.

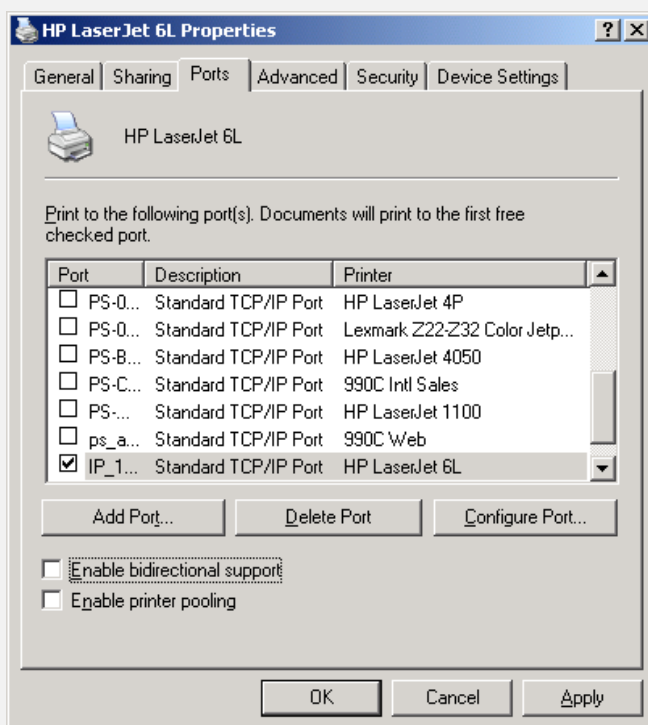

Problem No. 5

When printing from some software applications such as Power Point, it takes a long time and the print out is incorrect.

Solution No. 5

The problem is due to the printer, which is being configured to **Start printing after the first page is spooled**. To change this setting:

- Go to **Control Panel - Printers** and click on your printer.
- Then select **File - Properties - Details**.
- When the Details screen appears, click the *Spool Settings* button.
- When the Spool Settings dialogue box appears, choose *Start printing after last page is spooled* and click OK.

Problem No. 6

The Configuration button on the Printer Status screen in BiAdmin is grayed out, even though my printer is bi-directional.

Solution No. 6

The button is unavailable if the printer is busy. You must wait until the printer is idle.

Problem No. 7

My old printer cannot print or prints garbage.

Solution No. 7

If the printer you used is an old model with low speed, the following steps may solve this problem:

Try the following:

- Open the BiAdmin Utility.
- Click the *Printer Status* icon.
- Change the Printer Type setting to *Low Speed* or set the Handshake Signal setting to *Ack & Busy*.

Unix Troubleshooting

Problem No. 1	Print Server device is not recognized.
Solution No. 1	<p>Check the following:</p> <ul style="list-style-type: none">• The network cable is OK.• There are no routers between the Print Server and the UNIX host during IP address assignment.• There are no NetWare File Servers without TCP/IP support between the Print Server and the UNIX host.• You have used the correct hardware address, as shown on a sticker on the base of the device.• Use the ping command to see if the Print Server is a valid device on the network.
Problem No. 2	The Print Server's IP address is forgotten and it needs to be installed in a new environment.
Solution No. 2	<p>Use the "Reset" button to restore the factory default settings, as described below, then configure as for a new device.</p> <ol style="list-style-type: none">1. Turn the Print Server OFF.2. Press and hold the diagnostic button. While pressing the button, switch the Print Server ON.3. If you continue pressing the button for 10 seconds, a diagnostic page will be printed, showing the new (default) settings.

Technical Support

You can find the most recent software and user documentation on the **TRENDware website**. **TRENDware** provides **free technical support** for all customers for the duration of the warranty period on this product.

TRENDware Technical Support

Tel: +1-310-891-1100

Fax: +1-310-891-1111

**E-mail: support@trendware.com
www.trendware.com**

**Support Hours: 7:30AM ~ 6:00PM,
Monday ~ Friday (except holidays)**

Appendix A

Specifications

General Specifications

TE100-P1U Print Server	
Power Consumption	5.5w max.
External Power Adapter	9V DC
LEDs	2
USB Port (1.1)	1
Ethernet Connector	10/100BaseT
FCC / CE	FCC, CE. Class B
TE100-P1P Print Server	
External Power Adapter	9V DC
LEDs	4
Parallel Port	1 Male DB-36 connector
Ethernet Connector	10/100BaseT
FCC / CE	Class B

Environmental Specifications (all Models)	
Operating Temperature	0 ~ 40°C
Storage Temperature	-10 ~ 70°C
Shipping Temperature	-40 ~ 70°C
Operating Humidity	10 ~ 80%
Storage Humidity	5 ~ 90%
Shipping Humidity	5 ~ 100%

Parallel Port Pin Assignments

TE100-P1P Print Server		
Pin	Signal Name	Source
1	-Strobe	H
2	+Data 1	Bi-Di*
3	+Data 2	Bi-Di*
4	+Data 3	Bi-Di*
5	+Data 4	Bi-Di*
6	+Data 5	Bi-Di*
7	+Data 6	Bi-Di*
8	+Data 7	Bi-Di*
9	+Data 8	Bi-Di*
10	- ACK	P
11	+ Busy	P
12	+ Paper Error	P
13	+ Select	P
14	-Auto Feed	H
15	Not Defined	
16	Logic GND	
17	Chassis GND	
18	Peripheral Logic High	P
19-30	GND	
31	-Init	H
32	-Fault	P
33-35	Not Defined	
36	-SelectIn	H

* Data signals will be driven by some but not all peripheral devices.

Appendix B

Windows Server Configuration

Windows NT 4.0 Server

If using Windows NT 4.0, Microsoft *TCP/IP Printing Support* must be installed.

- If it is already installed, add a TCP/IP Remote Printer, as described below.
- Otherwise, install TCP/IP printing support, then add a TCP/IP Remote Printer.

Adding TCP/IP Printing Support

1. Go to *Start-Settings-Control Panel-Network*.
2. Click the *Service* option and ensure that **Microsoft TCP/IP Printing** is enabled. If it is not enabled, select the *Add* option and enable it as usual.
3. If you added services in step 2, reboot the computer for the changes to take affect.

Adding a TCP/IP Remote Printer

1. Go to *Start-Settings-Printer* and invoke the *Add Printer* wizard.
2. When prompted with "This printer will be managed by..", select **My Computer** and click *Next*.
3. Select **Add Port...**, then select **LPR Port** and click **New Port**.
4. In the *Name of Address of server providing lpd:* Dialog box, enter the Print Server's IP address.
5. In the *Name of printer or print queue on that server* dialog box, enter the appropriate logical printer number (e.g. L1) as previously configured on the Print Server.
6. Click *OK*. When returned to the *Printer Ports* window, simply select *Close* and then install your printer driver as usual.
7. When prompted whether or not the printer will be shared, select the **Sharing** radio button.
8. In the *Shared* dialog box, enter the shared printer name. (The shared name is how other users will see this printer.) Click *OK* to save and exit.

Client PCs can now be configured as described in *Chapter 4 - Client Configuration*.

Windows 2000/2003 Server

1. Start the *Add Printer Wizard*, select *Network Printer*, then click *Next* to browse for the Print Server.
2. Locate and double-click the Print Server, select the desired port, and click *Next*.

A message like the following will be displayed:

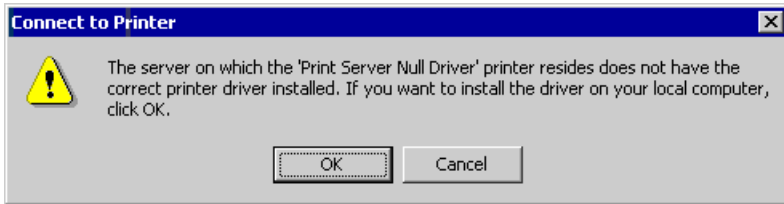

Figure 40: Windows 2000 Message

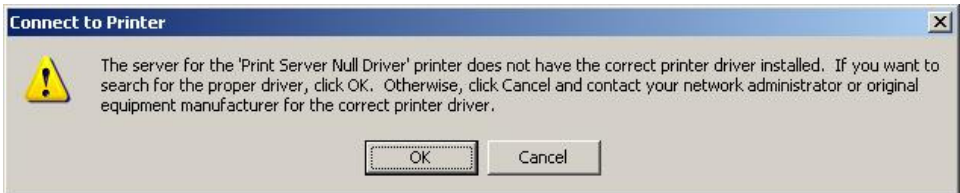

Figure 41: Windows2003 Message

3. Click "OK", and select the correct Manufacturer and Model for this printer.
4. Follow the prompts to complete the installation.
5. In the *Printers* folder, right-click the new printer, and select *Sharing*.
 - Select "Shared As:" and enter an appropriate name for this printer. Users will see this name when browsing for the printer during installation.
 - If desired, click "Additional Drivers" and install printer drivers for other versions of Windows, such as Windows 98. This will assist users during the installation process.
6. Click OK to close this Window. Configuration is now complete.

Client PCs can now be configured as described in *Chapter 4 - Client Configuration*.

Appendix C

Unix Systems

Overview

Your Wireless Print Server supports the LPD Unix printing method, which is supported by all common Unix systems.

You must configure both the Wireless Print Server itself and your Unix system, as described in the following sections.

Print Server IP Address Configuration

Because it supports dynamic IP Address allocation using DHCP or BOOTP, the Print Server ships with an IP Address of 0.0.0.0. This is NOT a valid IP Address.

Therefore, you must do ONE of the following:

- Check your **DHCP server** (if you have one), and determine the IP Address allocated to the Print Server.
- Configure your **BOOTP Server** (if you have one), to provide an IP address to the Print Server, then restart the Print Server.
- Use a Windows platform and run the **Setup Wizard** or **BiAdmin** utility to allocate a valid IP Address to the Print Server.
- Add an entry to the **arp** table to associate the hardware address of the Print Server with the desired IP address, as follows:

```
arp -s IP_Address 00:c0:02:xx:xx:xx
```

Where:

IP_Address is the IP Address you wish to assign to the Print Server.

00:c0:02:xx:xx:xx is the hardware address of the Print Server.

Example

```
arp -s 192.168.0.21 00:c0:02:12:34:56
```

You should then assign this IP address to the Print Server using your Web Browser, as described in *Chapter 6 - Web-based Management*.

Note:

The hardware address of the Print Server is shown on a sticker on the base of the device.

Other Print Server Configuration

The recommended method to configure the Print Server is to use the Web-based interface, as described in *Chapter 6 - Web-based Management*.

- Ensure that the TCP/IP settings are correct for you network.
- The logical printers (e.g. L1) must be configured correctly to match your system.

LPD Printing

LPD is a built-in printing protocol for most UNIX systems.

Configuration for the most common platforms is described below.

LPD on IBM AIX 4.15

Before proceeding, ensure that the Print Server has been assigned an IP Address. To setup your AIX system for LPD printing, perform the following steps.

1. Add the Print Server to **/etc/hosts.lpd**, using the name you assigned to the Print Server.
2. Start the LPD daemon if it is not running, using the following command:

```
start src -s qdaemon
```

3. Start the system administration tool **smit** and select *Print Spooling*.
4. Create the required number of queues (one for each logical printer) by selecting:

Add a Print Queue

Remote (Printer attached to Remote Host)

Standard Processing

5. Use the following information:

Field	Entry
Name of queue to add	Use a single-word queue name, which indicates which printer is attached.
Hostname for remote server	Print Server name as used in /etc/hosts.lpd.
Name of queue on remote server	Logical printer number (e.g. L1) to service this queue.
Type of print spooler on remote server	Use default value. (AIX Version xxx)

6. Ensure that the logical printers are configured in the Print Server.
7. Print using the following command:

```
lp -d printer_queue file_name
```

Where

printer_queue is one of the entries used in *Name of queue to add*.

file_name is the file you wish to print.

LPD on System V

Before beginning LPD Setup, ensure that an IP Address has been assigned to the Print Server. Keep the following points in mind:

The **remote host name** is the name of the Print Server.

The **remote printer name** is the print queue name for the Logical Printer. Logical printers also need to be configured on the Print Server itself.

If your UNIX asks for the LPD type, be sure to identify the service type as BSD. The Print Server's LPD protocol meets BSD system standards.

In the sample commands shown, *printer_name* is the name of the Print Queue serviced by the Print Server, and *Spooler_directory* is the name of the directory, which is used to spool the print jobs.

Procedure

Action	Sample Command
Stop Print Services	<code>/usr/lib/lpshut</code>
Add a System Printer	<code>/usr/lib/lpadmin -p <i>printer_name</i> -v /dev/null</code>
Restart the Print Services	<code>/usr/lib/lpsched</code>
Enable printing to the new printer device	<code>enable <i>printer_name</i></code>
Start accepting jobs for the new printer device	<code>accept <i>printer_name</i></code>
Create a spooling directory	<code>mkdir /usr/spool/<i>Spooler_directory</i></code>
Make spooling daemon the owner of this directory	<code>chown daemon /usr/spool/<i>Spooler_directory</i></code>
Create read/write permissions	<code>chmod 775 /usr/spool/<i>Spooler_directory</i></code>
Give permissions to LPD processes.	<code>chgrp daemon /usr/spool/<i>Spooler_directory</i></code>
Add remote printer(s)	See following section

Adding Remote Printers

A remote printer is added by inserting the following line in the `/etc/printcap` file.



Note!

The entry is really one line, but can be entered as shown. Use a TAB character where shown.

```
Printer_name|Remote_Printer_Alias:\
[TAB] :lp=: \
[TAB] :rm=PS_NAME: \
[TAB] :rp=Logical_Printer_name: \
[TAB] :sd=Spooler_directory: \
[TAB] :mx#0:
```

Where:

Printer_name is the Print Queue name used to store jobs for the corresponding logical printer.

PS_NAME is the Print Server name defined in */etc/hosts*.

Logical_Printer_name is the logical printer name on the Print Server. (e.g. L1)

Spooler_directory is the directory you created in Step 6.

Example:

```
Marketing|RP1_PS123456:\
[ TAB ] :lp=\
[ TAB ] :rm=PS_Rm203:\
[ TAB ] :rp=L1:\
[ TAB ] :sd=/usr/spool/Marketing:\
[ TAB ] :mx#0:
```

Repeat this process for each Logical Printer/Print Queue combination that you wish to create.

LPD on Linux

If using the command line, the procedure is the same as for System V. (above)

On recent Linux distributions, you can use the graphical X-windows interface instead of the command line. The procedure is described below, but may vary according to your version of Linux.

1. Start your X-windows shell.
2. Select *Control Panel*, then *Printer Configuration*.
3. Select *Add*. For the printer type, select *Remote Unix (lpd) Queue*.
4. Use the following data to complete the resulting dialog.

Field	Data
Name	Enter a name for this printer
Spool Directory	<i>/var/spool/lpd/name_of_printer</i>
File Limit	0 (no limit)
Remote Host	Name or IP Address of Print Server e.g. SC3000014 Note: host file entry is required to use the name instead of IP Address
Remote Queue	<i>Ln</i> Where <i>n</i> is the Logical Printer number By default, L1 is port 1, and L2 is port 2 if the Print Server has 2 ports.

5. Save this data, and exit the Printer Configuration. Configuration is now completed, and the printer is now available for use.

LPD on BSD

Before continuing, ensure that an IP Address has been assigned to the Print Server. Remember the following:

The **remote host name** is the name of the Print Server.

The **remote printer name** is the logical printer (e.g. L1) on the Print Server.

If asked for the LPD type, enter the service type as BSD.

In the sample commands shown, *printer_name* is the Print Queue serviced by the logical printer on the Print Server, and *Spooler_dir* is the name of the directory, which is used to spool the print jobs.

Procedure

Action	Sample Command
Create a spooling directory	<code>mkdir /usr/spool/Spooler_dir</code>
Set spooling daemon as owner of this directory	<code>chown daemon /usr/spool/Spooler_dir</code>
Create read/write permissions	<code>chmod 775 /usr/spool/Spooler_dir</code>
Give permissions to LPD processes	<code>chgrp daemon /usr/spool/Spooler_dir</code>
Add remote printer(s)	See below
Start lpd print mechanism	<code>lpd start printer_name</code>

Adding Remote Printers

A remote printer is added by inserting the following line in the `/etc/printcap` file.



Note!

The entry is really one line, but can be entered as shown. Use a TAB character where shown.

```
Printer_name|Remote_Printer_Alias:\
[ TAB ] :lp=: \
[ TAB ] :rm=PS_NAME:\
[ TAB ] :rp=Logical_Printer_name:\
[ TAB ] :sd=Spooler_directory:\
[ TAB ] :mx#0:
```

Where:

Printer_name is the Print Queue name used to store jobs for the corresponding logical printer.

PS_NAME is the Print Server name defined in `/etc/hosts`.

Logical_Printer_name is the logical printer name on the Print Server. (e.g. L1)

Spooler_directory is the directory you created in Step 6.

Example:

```
Marketing|RP1_PS123456:\
[TAB] :lp=:\
[TAB] :rm=PS_Rm203:\
[TAB] :rp=L1:\
[TAB] :sd=/usr/spool/Marketing:\
[TAB] :mx#0:
```

Repeat this process for each Logical Printer/Print Queue combination that you wish to create.

Printing using LPD

For LPD printing instructions, refer to your UNIX manual. The following example is for a BSD system:

```
lpr -P printer_name filename
```

Where:

printer_name is the name of the Print Queue defined on the Unix host.

filename is the name of the file you wish to print.

Example:

```
lpr -P Marketing /etc/hosts
```

In the above example, the `/etc/hosts` file is sent to the printer queue `Marketing`. It will then be sent to the logical printer associated with this queue.

Appendix D

NetWare

Overview

- The Print Server must be configured as a valid device on your TCP/IP network. This printing method uses LPR over TCP/IP, not the Netware protocol.
- To use NDPS (Novell Distributed Printing Services), the Novell server must be running Novell NetWare 5, and the PCs (clients) must be running IntranetWare Client V2.2. or later.

The following procedure is designed to enable **Public Access Printing** under NDPS. *Public Access Printing* allows anybody on the network to access the printer.

Creating an NDPS Manager Object

If an NDPS Manager Object already exists, skip this procedure and proceed to *Creating an NDPS Printer Agent*.

1. Login to NetWare 5.0 Server as Admin and start the NetWare Administrator program Nwadmn32.exe.
2. Select the container on NetWare Administrator where you want the NDPS Manager object to reside. (e.g. TeSupp)
3. Select *Create - Object* from the menu bar to view the *New Object* dialog.
4. Select *NDPS Manager* as the object to create. The *Create NDPS Manager Object* window shown below will appear.

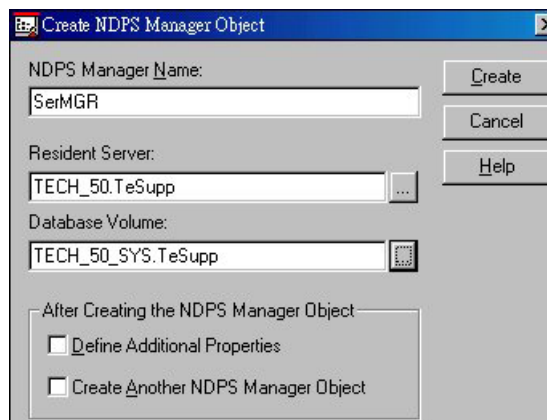

Figure 42: Create NDPS Manager Object

5. Type a name in the NDPS Manager Name.(e.g. SerMGR in Figure 1 above)
6. Browse the Resident Server and select where you want the NDPS Manager object to be assigned. (e.g. TECH_50.TeSupp in figure 1 above)
7. Browse the Database Volume and select where you want the NDPS Manager database to be assigned. (e.g. TECH_50_SYS.TeSupp in figure 1 above)
8. Click **Create**. The new NDPS Manager will appear in the main browser window.

To start the NDPS Manager in future, enter the following command at the console:

```
LOAD NDPSM
```

then select the NDPS Manager object.

To start the NDPS Manager whenever you bring up the server, add a command like the following to your server's AUTOEXEC.NCF file:

```
LOAD NDPSM SerMGR.TeSupp
```

The last item is the name of the NDPS Manager object you wish to load.

9. After creating an NDPS Manager, you can create NDPS printers by using NetWare Administrator, as explained below.

Creating an NDPS Printer Agent

To create Public Access Printers using the NDPS Manager Object in NetWare Administrator, follow this procedure:

1. Start the NDPS Manager object you will be using to control the Printer Agent.
2. At the *Identification* page, click the *Printer Agent List*.
3. Click *New* to see the *Create Printer Agent* window, as shown below.

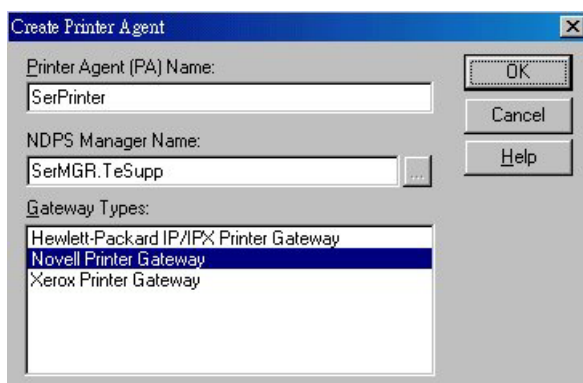

Figure 43: Create Printer Agent

4. Enter the desired name for the *Printer Agent (PA) Name*.
5. Normally, the *NDPS Manager* will be the NDPS Manger object you are using.
6. Select *Novell Printer Gateway* in the *Gateway Type*. (see figure2 above)
7. Click *OK* and then select the available printer.
8. Select *Remote (LPR on IP)* in the *Connection Type*.
9. Click *Next* to see the following *Configure Port Handler* screen.

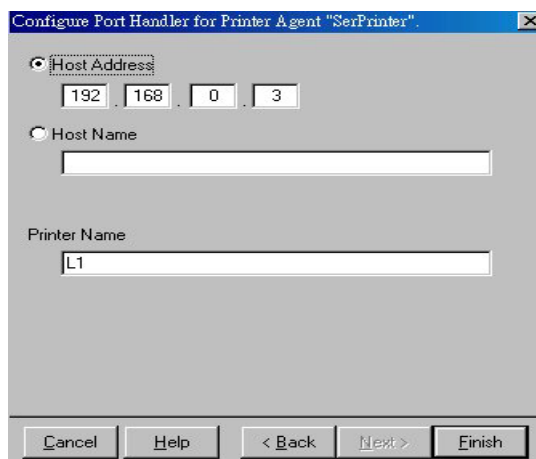

Figure 44 Configure Port Handler

10. In the *Host address IP* field, enter the IP Address previously assigned to the Print Server device.
11. In the *Printer Name* field, enter the Logical Port name on the Print Server. (L1 for Port 1, L2 for port 2).
12. Click *Finish*, then select appropriate drivers for Windows 98 etc as required.
13. The new Printer Agent will now appear in the Printer Agent List window.

Repeat this procedure for any other ports on the Print Server, or for any other logical printers you wish to use.

Client PCs can now be configured as described in *Chapter 4 - Client Configuration*.

Technical Support

You can find the most recent software and user documentation on the **TRENDware website**. **TRENDware** provides **free technical support** for all customers for the duration of the warranty period on this product.

TRENDware Technical Support

Tel: +1-310-891-1100

Fax: +1-310-891-1111

**E-mail: support@trendware.com
www.trendware.com**

**Support Hours: 7:30AM ~ 6:00PM,
Monday ~ Friday (except holidays)**