

TV-IP400W

Advanced Pan & Tilt Wireless
Internet Camera Server

User's Guide



Copyright ©2005. All Rights Reserved. TRENDware International, Inc.

TABLE OF CONTENTS

ABOUT THIS GUIDE.....	3
1. INTRODUCTION	4
FEATURES AND BENEFITS	5
UNPACKING THE PACKAGE	7
SYSTEM REQUIREMENT	8
PHYSICAL DESCRIPTION	9
2. HARDWARE INSTALLATION	12
ATTACHING THE METAL CLIP.....	12
CONNECTING THE ETHERNET CABLE	13
ATTACHING THE POWER SUPPLY	13
3. SECURITY.....	14
4. APPLICATION OF THE CAMERA	15
APPLICATIONS	16
APPLICATION DIAGRAMS OF THE CAMERA	17
5. USING THE CAMERA	20

WEB CONFIGURATION UTILITY.....	20
SYSTEM ADMINISTRATION.....	22
VIEWING VIDEO	51
6. IPVIEW SE	55
INSTALLATION.....	55
GETTING STARTED	60
HOW TO ADD A CAMERA	62
HOW TO CHANGE CAMERA	67
CONNECT/DISCONNECT THE IMAGE.....	68
HOW TO DELETE A CAMERA	71
EXTRA INFORMATION.....	72
HOW TO ADJUST THE PROPERTY SETTING	73
ADJUST THE RECORDING SETTING.....	79
7. APPENDIX.....	80
A. FREQUENTLY ASKED QUESTIONS.....	80
B. PING YOUR IP ADDRESS	83
C. TROUBLE SHOOTING	84
D. TIME ZONE TABLE	88
E. XPLUG CONTROL INSTALLATION.....	90
F. ADJUST INTERNET CAMERA FOCUS	94
G. SPECIFICATION.....	95
H. GLOSSARY OF TERMS	97

ABOUT THIS GUIDE

This manual provides instructions and illustrations on how to use your Wireless Pan/Tilt Internet Camera, includes:

- Chapter 1, **Introduction**, provides the general information on the camera.
- Chapter 2, **Hardware Installation**, describes the hardware installation procedure for the camera.
- Chapter 3, **Security**, explains the security feature of the camera.
- Chapter 4, **Application of the Camera**, provides the illustrations of the camera's applications.
- Chapter 5, **Using the Camera**, guides you through the configuration using the web browser.
- Chapter 6, **IPView SE**, helps you to install and use the software.
- Chapter 7, **Appendix**.

Please note that the illustrations or setting values in this manual are **FOR YOUR REFERENCE ONLY**. The actual settings and values depend on your system and network. If you are not sure about the respective information, please ask your network administrator or MIS staff for help.

INTRODUCTION

Thank you for purchasing the Wireless Pan/Tilt Internet Camera, a standalone system that can be connected directly to an Ethernet or Fast Ethernet, and also supported by the wireless transmission based on the IEEE 802.11g standard. Compared to the conventional PC camera, the Wireless Pan/Tilt Internet Camera features a built-in CPU and web-based solutions that can provide a cost-effective solution to transmit the real-time high-quality video images for monitoring. The camera can be managed remotely, so that you can use a web browser to access and control it from any notebook/desktop PC over the Intranet or Internet. The simple installation procedures and web-based interface allow you to integrate it into your network easily. With comprehensive applications supported, the Internet camera is your best solution for remote monitor, high quality, and high performance video images.

Features and Benefits

Simple To Use

The Wireless Pan/Tilt Internet Camera is a standalone system with built-in CPU, no special hardware (such as a PC frame capture card) or software required. The camera supports DirectX 9.0; therefore, the only requirement you need is the web browser software such as Internet Explorer 5.0 or above. Once you have a valid IP Address, just connect it and you can view the picture from your camera. In addition, the camera's pan/tilt function allows you to adjust the camera for optimal viewing angle. You can tilt the camera right or left (up to 170/170 degrees), forward or backward (up to 45/90 degrees) using the Web Configuration Utility.

Support Variety of Platforms

The camera supports TCP/IP networking, SMTP e-mail, HTTP and other Internet related protocols. It can be utilized in a mixed operating system environment, including Windows 98SE/ME/2000/XP and Windows NT 4.0. It can be integrated easily into other www/Intranet applications.

Web Configuration

Applying a standard web browser, the administrator can configure and manage the camera directly from its own web page via the Intranet or Internet. Up to **64** users name and password are permitted with privilege setting controlled by the administrator.

Remote Utility

The powerful IPView SE application assigns the administrator with a pre-defined user ID and password, allowing the administrator to modify the camera settings from the remote site via Intranet or Internet. When new firmware is available, you can also upgrade remotely over the network for added convenience. Users are also allowed to monitor the image, and take snapshots.

Broad Range of Applications

With today's high-speed Internet services, the camera can provide the ideal solution for live video images over the Intranet and Internet for remote monitoring. The camera allows remote access from a web browser for live image viewing, and allows the administrator to manage and control the camera anywhere and anytime in the world. Apply the camera to monitor various objects and places such as homes, offices, banks, hospitals, child-care centers, amusement parks and other varieties of industrial and public monitoring. The camera can also be used for intruder detection; in addition, it can capture still images for archiving and many more applications.

Unpacking the Package

Unpack the package and check all the items carefully. In addition to this *User's Guide*, be certain that you have:

- One Wireless Pan/Tilt Internet Camera (with antenna)
- One External Power Adapter (5V DC, 2A)
- One RJ-45 Ethernet Cable
- One Metal Clip
- One Quick Installation Guide
- One Installation CD-ROM

If any item contained is damaged or missing, please contact your local dealer immediately. Also, keep the box and packing materials in case you need to ship the unit in the future.

System Requirement

Networking

Local Area Network:

- 10Base-T Ethernet or 100Base-TX Fast Ethernet

Wireless Local Area Network (wireless model):

- IEEE 802.11g Wireless LAN

Accessing the Camera

For Web Browser Users

- Operating System: Microsoft® Windows® 98SE/ME/2000/XP
- CPU: Intel Pentium II, 266 MHz or above
- Memory Size: 32MB (64MB recommended)
- Resolution: 800x600 or above
- Microsoft® Internet Explorer 5.0 or above

For IPView SE Application Users

- Operating System: Microsoft® Windows® 98SE/ME/2000/XP.
- CPU: Intel Pentium III, 450 MHz or above
- Memory Size: 128 MB (256 MB recommended)
- Resolution: 800x600 or above

Physical Description

This section describes the externally components' features of your camera.

Front Panel

There are two LED indicators on the front panel of the camera: **Power LED** and **Link LED**.



1. Power LED

The Power LED is positioned on the right side of the two LEDs. A steady **BLUE** light confirms that the camera is powered on.

2. Link LED

The Link LED is positioned on the left side of the two LEDs. A steady **ORANGE** light confirms that the camera has good connection to LAN connectivity.

Dependent on the data traffic, the LED will begin to flash to indicate that the camera is receiving/sending data from/to the network.

Rear Panel

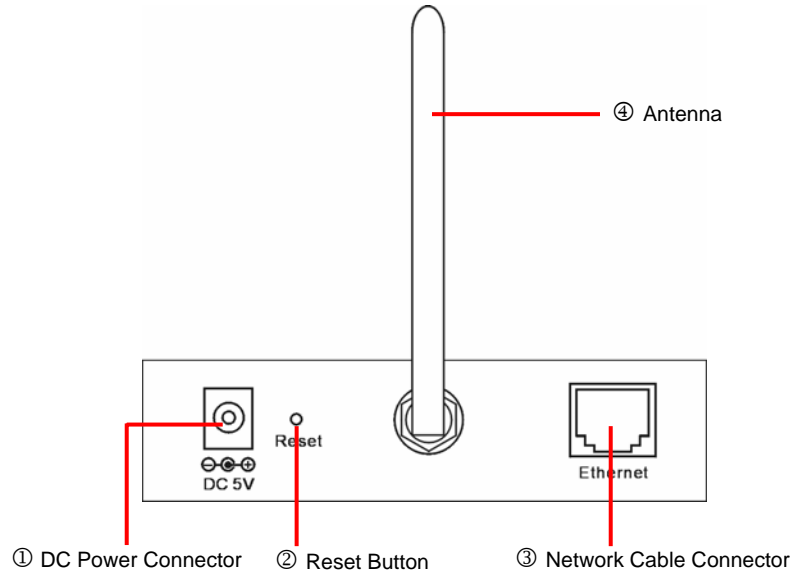

1. DC Power Connector

The DC power input connector is located on the camera's rear panel, and is labeled DC5V 2.5A with a single jack socket to supply power to the camera. Power will be generated when the power supply is connected to a wall outlet.

2. Reset Button

Reset will be initiated when the reset button is pressed once, and Power LED begins to flash.

Factory Reset will be initiated when the reset button is pressed continuously for three seconds or when Power LED begins to

light up. Release the reset button and the Power LED will begin to flash, indicating the camera is changing to factory reset. When factory reset is completed, the camera will be set to default on channel 11 and SSID is set as “NULL String” (This default setting will let the camera connect to **ANY** access point on the infrastructure network). The IP address will also return to the default setting as ***192.168.0.20***.

3. Network Cable Connector

The camera’s rear panel features an RJ-45 connector for connections to 10Base-T Ethernet cabling or 100Base-TX Fast Ethernet cabling (which should be Category 5 twisted-pair cable). The port supports the N-Way protocol and “AutoMDIX” function, allowing the camera to automatically detect or negotiate the transmission speed of the network.

4. Antenna

The rotatable external antenna allows you to adjust its position to obtain the maximum signal.

HARDWARE INSTALLATION

Attaching the Metal Clip

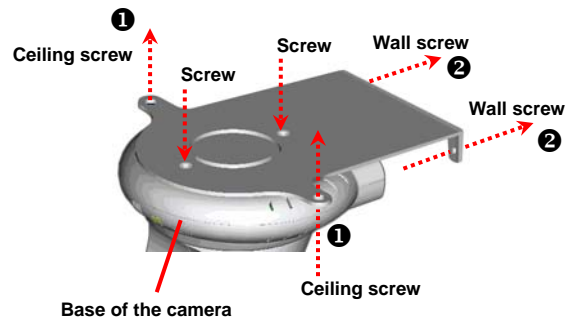

To attach the metal clip, remove the two rubber pads under the base of the camera firstly. Place the metal clip onto the camera base, and align the two holes of metal clip with two screw holes on the base. Secure the metal clip to the base with two screws (provided). Then, you can:

1. Install the camera to the ceiling using two ceiling screws (1);
or,
2. Install the camera to the wall using two wall screws (2).

Connecting the Ethernet cable

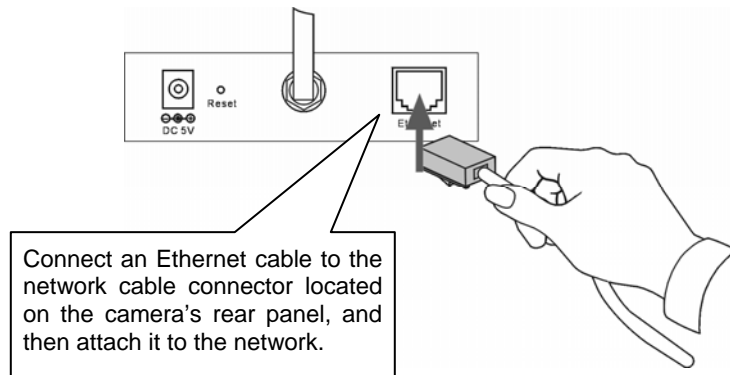

Attaching the Power Supply

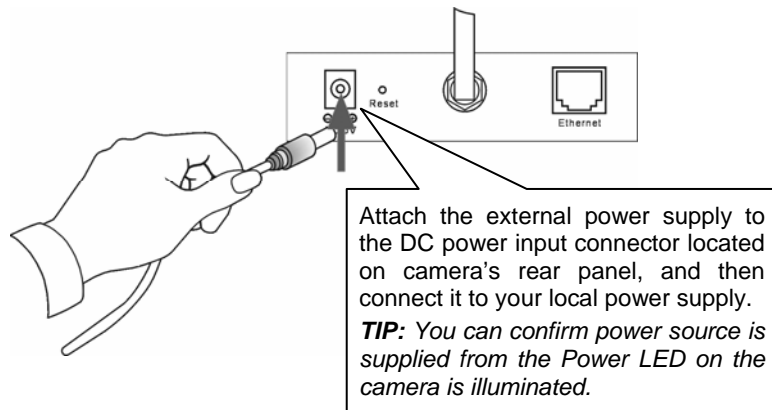

SECURITY

To ensure the highest security and prevent unauthorized usage of the camera the Administrator has the exclusive privilege to access the System Administration for settings and control requirements to allow users the level of entry and authorize the privileges for all users. The camera supports multi-level password protection and access to the camera is strictly restricted to define the user who has a “User Name” and “User Password” that is assigned by the Administrator.

The administrator can release a public user name and password so when remote users access the camera they will have the right to view the image transmitted by the camera.

NOTE: *Since the default settings are Null String, it is highly recommended to set the "Admin ID" and "Admin Password" when you are the first time to use the camera. Once the ID and Password are defined, only the administrator has the access to management the camera. This procedure should be done as soon as possible since the security features with the camera will not be enabled until the "Admin ID" and "Admin Password" is defined.*

APPLICATION OF THE CAMERA

The camera can be applied in wide variety of applications. With the built-in CPU, it can work as a standalone system that provides a web-based solution transmitting high quality video images and sounds for monitoring purposes. It can be managed remotely, accessed and controlled from any PC desktop over the Intranet or Internet via a web browser. With the easy installation procedure, real-time live images will be available. In addition, once the camera is installed coupled with the IPView SE application, you can further expand the scope of the camera.

The following section will provide the typical applications for the camera along with the IPView SE application, and also includes some basic knowledge to assist in the installation and configuration of the camera.

Applications

- Monitoring of local and remote places and objects such as construction sites, hospitals, amusement parks, schools and day-care centers through the use of a web browser.
- Capture single frame images from the IPView SE application.
- Configure the camera to upload image or send-mail messages with a single frame image.

Application Diagrams of the Camera

Home Applications

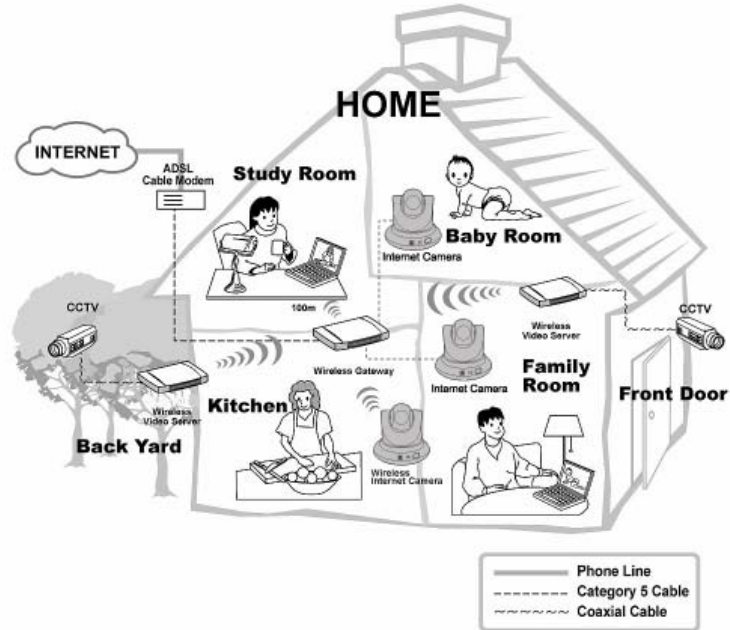

SOHO Applications

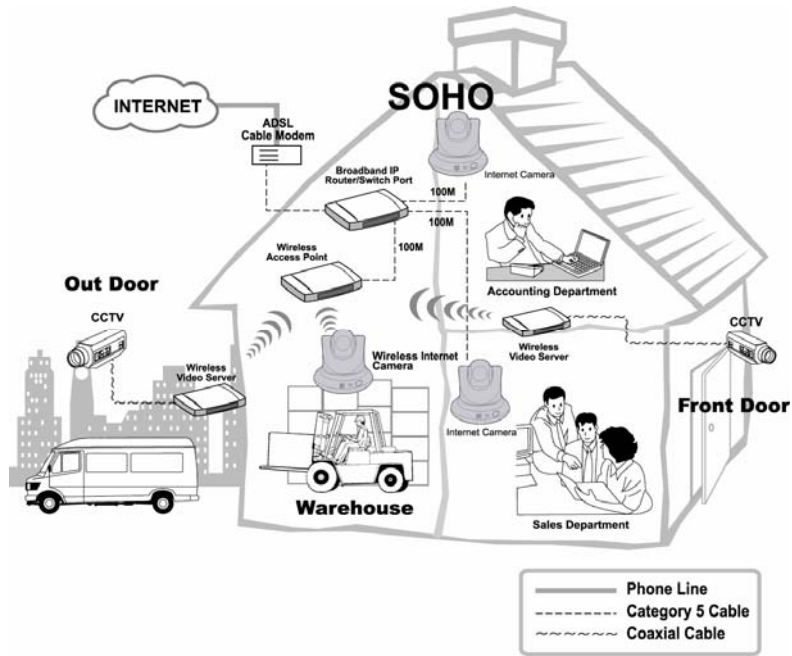

Enterprise Applications

ENTERPRISE

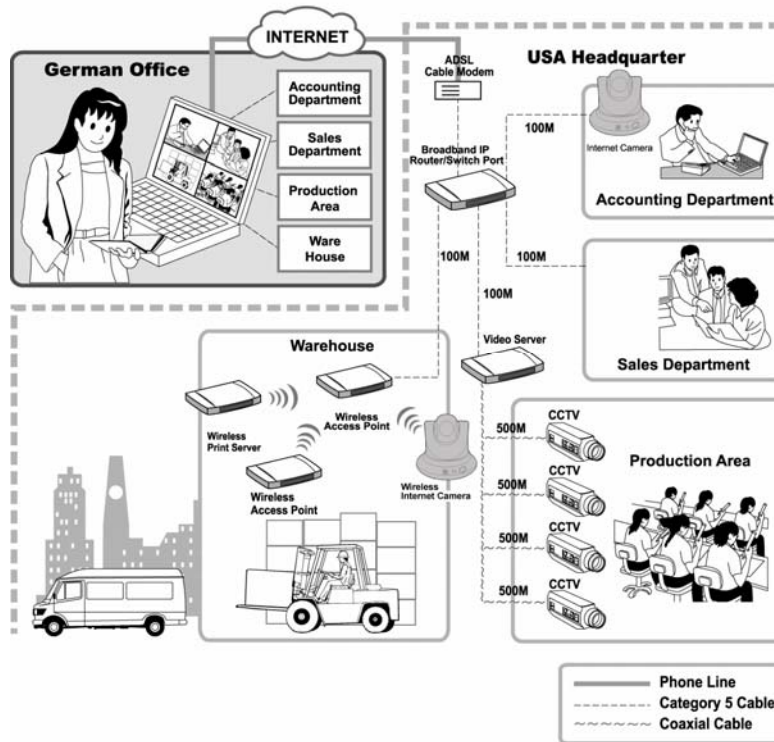

USING THE CAMERA

You can access and manage the camera through: 1) a web browser, and 2) the enclosed software IPView SE. This chapter describes the Web Configuration Utility, and provides the instructions on using the camera with a web browser.

Web Configuration Utility

The camera must be configured through its built-in Web-based Configuration. (*Extensive knowledge of LAN will be helpful in setting up the camera.*)

From the web browser, enter the default IP address to access the Welcome screen of the camera. To configure your camera, type ***http://192.168.0.20*** in the address box. The number is the default IP address of your camera. Then, press [Enter].

NOTE: *The computer's IP address must correspond with the camera's IP address in the same segment for the two devices to communicate.*

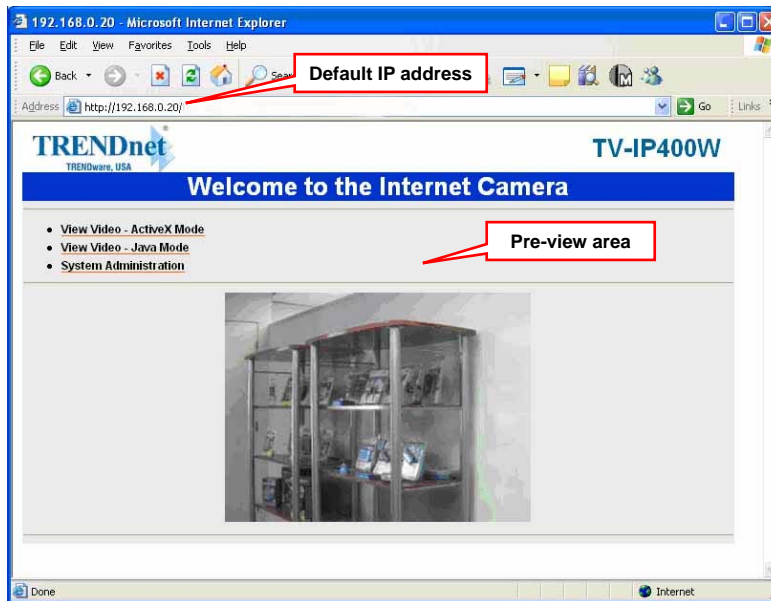

Welcome Screen of the Configuration Utility

After the default IP address is entered from the browser, the camera Welcome screen will appear with a still image. There will be three options to choose from to set-up and view your camera, including:

- **View Video – ActiveX Mode**
- **View Video – Java Mode**
- **System Administration**

System Administration

Under the Welcome screen of the Configuration Utility, click **System Administration** to enter the administration window that contains the settings required for the camera in the top menu bar, including **Management**, **Configuration**, **Tools**, **Help**, and **Home**.

***TIP:** Once you have changed the settings in each option, click **Save** to store the settings, or **Cancel** to abandon, or **Refresh** to reload the status. During the configuration, whenever you click **Home** in the top menu bar will make you return to the Welcome window.*

System Administration → Management

The Management window contains the information of your configuration. Click the items in the left column to view your settings, including: **System**, **Video**, **Network**, and **User**.

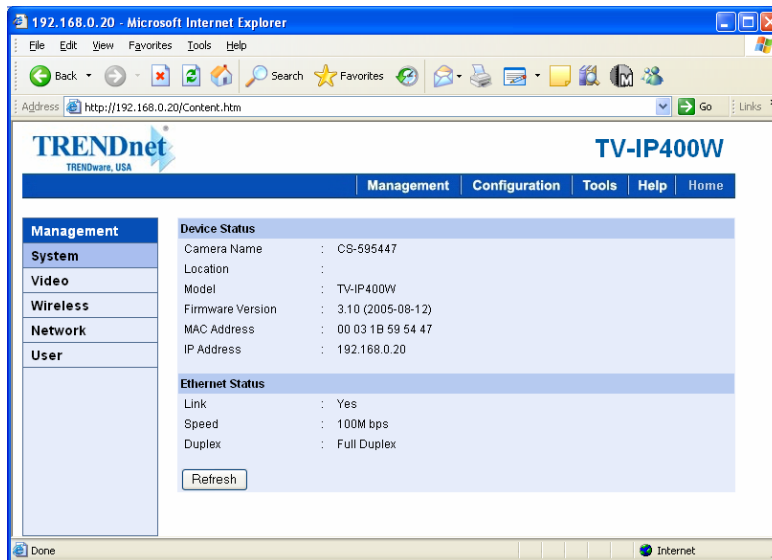

System

Click the **System** item in the left column to display the device status of your camera (as shown above).

- **Device Status:** The information about the camera, including the Camera Name, Location, Model, Firmware Version, MAC Address and IP Address, can be found in this field.
- **Ethernet Status:** You can monitor the networking status in this field, including the Link (network connection), Speed, and the Duplex mode.

Video

Click the **Video** item in the left column to display the video configuration of your camera.

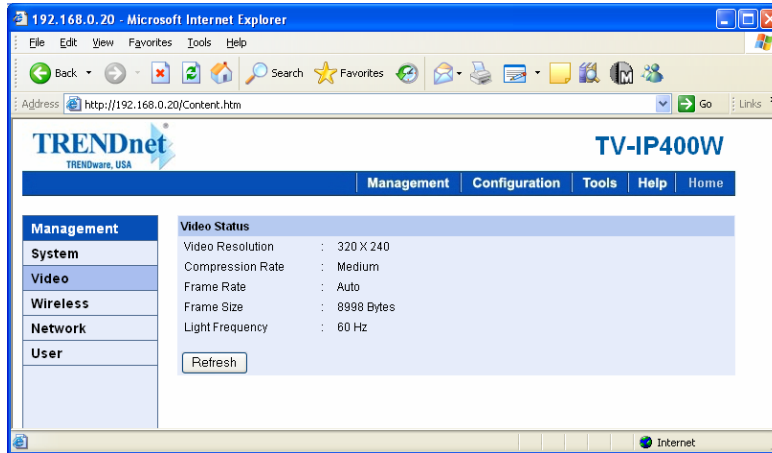

- **Video Status:** The video configuration about the camera, including the Video Resolution, Compression Rate, Frame Rate, Frame Size and IP Address, can be found in this field.

Wireless

Click the **Wireless** item in the left column to display the information of the wireless LAN.

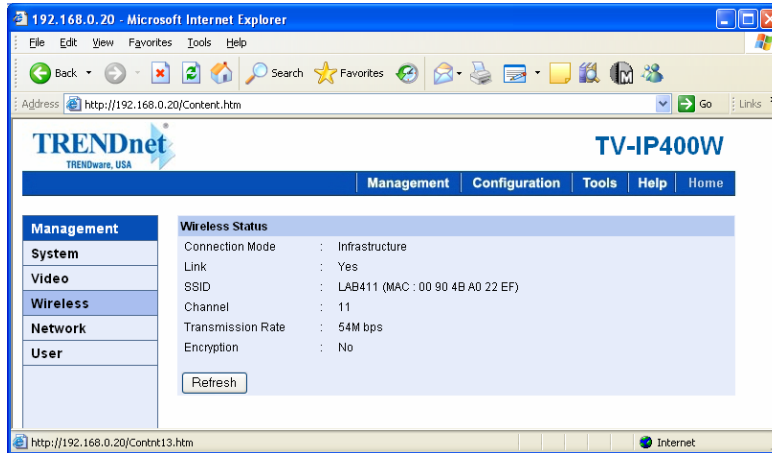

- **Wireless Status:** The items in this field display the information of the wireless LAN, such as the Connection Mode (Infrastructure or Ad-Hoc), Link, SSID, Channel, Transmission Rate, and WEP Encryption.

Network

Click the **Network** item in the left column to display the information of the LAN.

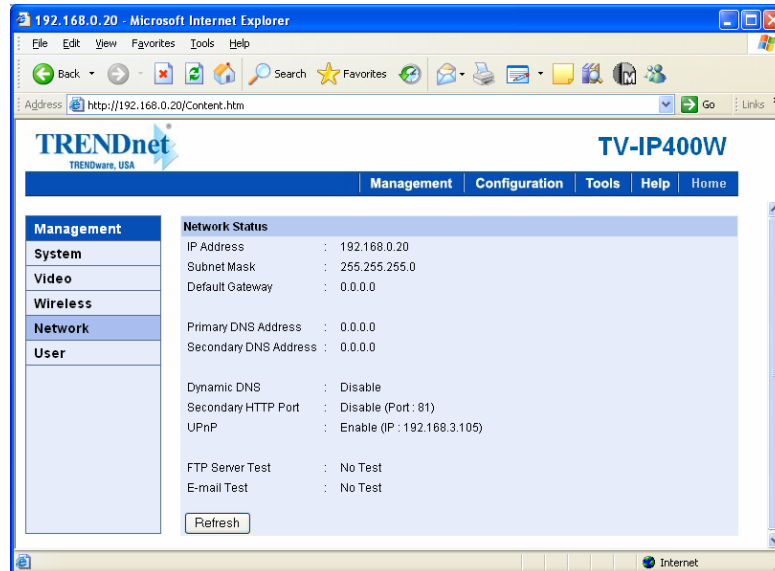

- **Network Status:** The items in this field display the information of the LAN, such as the IP Address, Subnet Mask, Default Gateway, Primary/Secondary DNS Address, Dynamic DNS, Secondary HTTP Port, UPnP, as well as the FTP/E-mail upload status.

User

Click the **User** item in the left column to display the user(s) information.

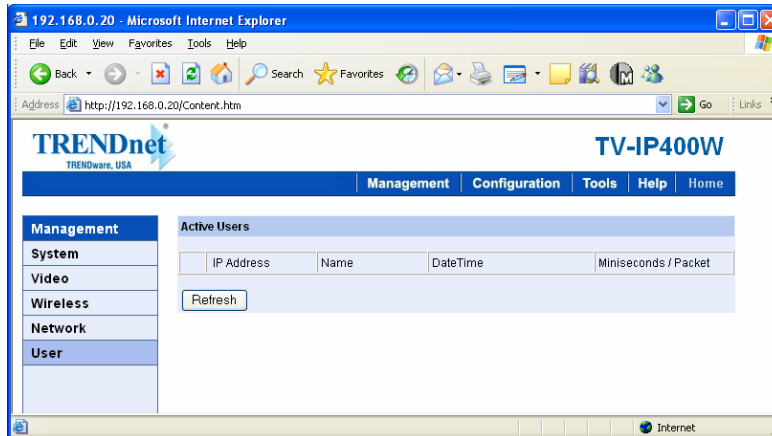

- **Active Users:** The items in this field display the user(s) information, including the user(s) IP address, Name, and DateTime.

System Administration → Configuration

The **Configuration** window contains commands for settings that are required to input key details to setup the camera for operation. Click **Configuration** in the top menu bar and the Configuration window will appear as below:

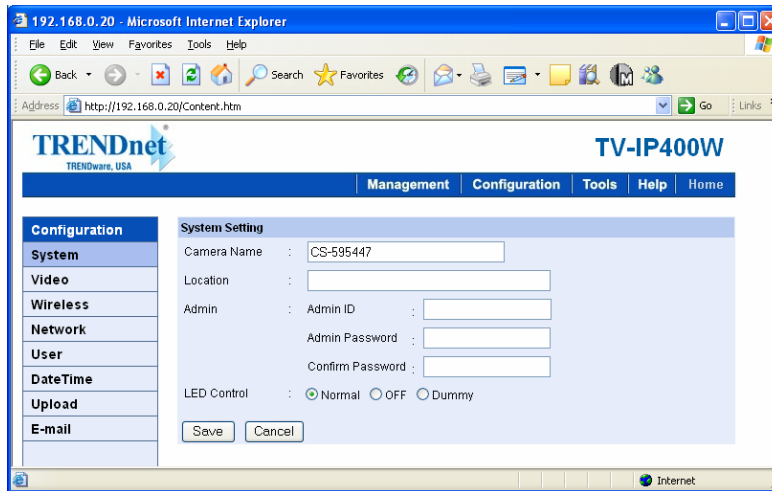

System

Click the **System** item in the left column to setup the basic configuration of your camera (as shown above).

- **System Setting:** In this field, you can configure the basic information of your camera.
 - **Camera Name:** This field is used to enter a descriptive name for the device. The default setting for the Camera Name is **CS-xxxxxx**, where **xxxxxx** is the last six digit of the MAC Address. The maximum length is 32 (printable ASCII).

- **Location:** This field is used to enter a descriptive name for the location used by the camera (optional).
- **Admin:** This field is used to enter the administrator name along with the password to access the System Administration settings. Be sure to enter the password twice to confirm the details once in the *Admin Password* field and again in the *Confirm Password* field.

The default setting for administrator is blank space (Null String), and you need to key in the administrator name with a maximum length of 12 (printable ASCII) characters and enter the administrator password with a maximum length of 8 (printable ASCII) characters.

It is highly recommended to set the Admin ID and Admin Password as soon as possible to enable security option for the camera to function.

- **LED Control:** This option allows user to setup the LED illumination as desired. This feature provides the flexibility when surveillance activity is ON.

There are three options as follows:

Normal	Power - Steady On of the LED indicator. Link - Steady On of the LED indicator. When WLAN activity is present the LED indicator will flash steadily.
OFF	Power - LED indicator is off. Link - LED indicator is off.
Dummy	Power - Steady On of the LED indicator. Link - Steady On of the LED indicator with random flashing.

The default setting for the LED control is at *Normal*. When you have configured the LED control, the correct illumination will be set after 1 minute.

Video

Click the **Video** item in the left column to setup the image configuration of your camera.

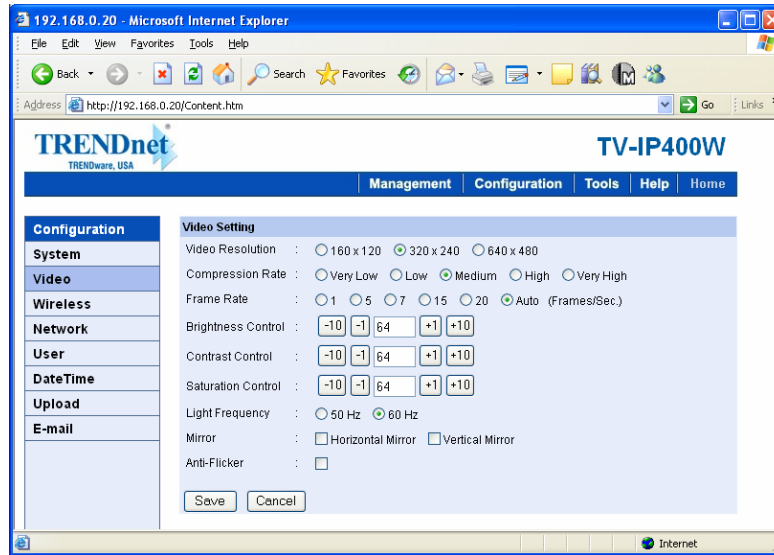

- **Video Setting:** In this field, you can configure the basic information of your camera.
 - **Video Resolution:** Select the desired video resolution format, including *160x120*, *320x240* (default) and *640x480*.
 - **Compression Rate:** Select the desired compression rate with five levels from *Very Low* to *Very High*. Higher video compression rate

will generate more compact file size with less video quality and vice-versa. The default setting is *Medium*.

- **Frame Rate:** Select the frame rate desired with default setting at *Auto* for optimal frame rate.
- **Brightness Control:** Adjust the brightness level with default setting at *64*.
- **Contrast Control:** Adjust the contrast level with default setting at *64*.
- **Saturation Control:** Adjust the saturation with default setting at *64*.
- **Light Frequency:** Adjust the light frequency to suit your area of operation from the options either *50 Hz* or *60 Hz* (default).
- **Mirror:** You can select the *Horizontal Mirror* or *Vertical Mirror* option to display the image in a mirror mode. This function allows you to place the camera more flexibly (for example, you can attach the camera on the ceiling).

Wireless

Click the **Wireless** item in the left column to setup the wireless LAN configuration of your camera.

Configuration	Wireless Interface
System	Connection Mode : <input checked="" type="radio"/> Infrastructure <input type="radio"/> Ad-Hoc
Video	SSID : <input type="text"/> (Manually Input or Select from List)
Wireless	<input type="text" value="LAB411"/> <input type="button" value="Site Survey"/>
Network	Wireless Channel : <input type="text" value="11"/>
User	Transmission Rate : <input type="text" value="Fully Automatic"/>
DateTime	Encryption
Upload	<input checked="" type="radio"/> Disable
E-mail	<input type="radio"/> WEP Encryption
	Length : <input checked="" type="radio"/> 64bits <input type="radio"/> 128bits
	Format : <input type="radio"/> ASCII <input checked="" type="radio"/> HEX
	Key 1 : <input type="text"/>
	Key 2 : <input type="text"/>
	Key 3 : <input type="text"/>
	Key 4 : <input type="text"/>
	Encrypt Data Transmissions Using : <input type="text" value="Key 1"/>
	Authentication Type : <input type="radio"/> Open System <input type="radio"/> Shared Key <input checked="" type="radio"/> Both
	<input type="radio"/> WPA-PSK
	Preshared Key: <input type="text" value="PSK12345"/> (8-63 ASCII or 64 HEX characters)
	Advanced Setting
	Beacon Interval : <input type="text" value="100"/> (ms)
	Preamble : <input checked="" type="radio"/> Long <input type="radio"/> Short
	<input type="button" value="Save"/> <input type="button" value="Cancel"/>

- **Wireless Interface**

- **Connection Mode:** Use this option to determine the type of wireless communication for your camera. There are two choices of Infrastructure mode and Ad-Hoc mode. The default setting is *Infrastructure*.
- **SSID:** The SSID (Service Set Identifier) is the name assigned to the wireless network. It will auto-detect and display the SSID of wireless network connected

in this box (it displays *default* initially). This default setting will let the camera connect to ANY access point under the infrastructure network mode.

To connect the camera to a specific access point on the network, please make sure to set the SSID of the camera to correspond with the access point's SSID for communication. Type any string up to 32 characters long (spaces, symbols, and punctuation are not allowed) in the Network Name box.

To connect the camera to an Ad-Hoc wireless workgroup, make sure to set the same wireless channel and SSID to match with the PC/Notebook's configuration for direct wireless communication.

● **Wireless Channel:** This pull-down menu provides the wireless channel for communication. A "channel" is a range of frequencies to be used in communication between the camera and access point in Infrastructure mode, or the camera and PC/Notebook in Ad-Hoc mode. Select the appropriate channel from the list provided depending on the regulatory region where the unit is sold. The default setting is at channel *11*.

● **Transmission Rate:** Select the data transmit rate from this pull-down menu. The default setting is *Fully Automatic*.

- **WEP Encryption**

● **WEP Encryption:** Wireless network communications can be intercepted easily. WEP (Wired Equivalent Privacy) is an encryption method specified by the IEEE 802.11g standard to make any intercepted communications extremely difficult to

interpret by unauthorized parties. The default setting for this option is *Disable*.

- **WEP Key Format:** To enable WEP Encryption, you should decide the encryption format first by selecting the *ASCII* or *HEX* option, and then input the WEP key (in the following Key 1~4 box).

ASCII input format:

ASCII format causes each character you type to be interpreted as an eight-bit value. All unaccented upper- and lower-case Western European characters that can be input through your keyboard's typing zone are valid. To setup a 64-bit WEP key, input 5 ASCII characters. For example, '12345'. To setup a 128-bit WEP key, input 13 ASCII characters. For example, '1234567890123'. These character counts result in bit counts of 40 and 104 respectively; the camera will automatically pad your input to a bit count of 64 or 128.

HEX input format:

Hex format causes each pair of characters you type to be interpreted as an eight-bit value in hexadecimal (base 16) notation. Only the digits 0 through 9 and the letters A through F (in upper or lower case) are valid. To setup a 64-bit WEP key, input 10 HEX format. For example, '3132333435', which is the same with ASCII input '12345'. To setup a 128-bit WEP key, input 26 HEX format. For example, '31323334353637383930313233', which is the same with ASCII input '1234567890123'. These character counts result in bit counts of 40 and 104, respectively; the camera will automatically pad your input to a bit count of 64 or 128.

- **Encrypt Data Transmissions Using:** Use this pull-down menu to decide to use Key 1, 2, 3 or 4 for encryption).
- **Advanced Setting:** In this field, you can setup more advanced configuration.

- **Beacon Interval:** This option defines time interval between two images sent.
- **Preamble:** A preamble is a signal used in wireless environment to synchronize the transmitting timing including Synchronization and Start frame delimiter. Please NOTE that if you want to change the Preamble type into *Long* or *Short*, please check the setting of access point.
- **Authentication Type:** *Open System* communicates the key across the network. *Shared Key* allows communication only with other devices with identical WEP settings. The default setting is *Both*.

Network

Click the **Network** item in the left column to setup the LAN configuration of your camera.

TRENDnet TV-IP400W

Management Configuration Tools Help Home

Configuration

- System
- Video
- Wireless
- Network**
- User
- DateTime
- Upload
- E-mail

TCP/IP

IP Address Mode : Fixed IP

IP Address : 192.168.0.20

Subnet Mask : 255.255.255.0

Default Gateway : 0.0.0.0

Dynamic IP (DHCP)

PPPoE

User ID :

Password :

DNS IP Address : 1. 0.0.0.0

2. 0.0.0.0

Dynamic DNS : Enable Disable

Service Provider : DynDNS.org

Host Name :

User Name/E-mail :

Password/Key :

Second HTTP Port : Enable Disable

Port Number : 81

UPnP : Enable Disable

Save Cancel

- **TCP/IP:** The items in this field display the information of the local area network.
 - **IP Address Mode:** This field provides your with three options to select the IP Address Mode:

Fixed IP	You can select this option and enter the IP address directly. The default settings are: <ul style="list-style-type: none">● IP Address – 192.168.0.20
-----------------	---

	<ul style="list-style-type: none"> ● Subnet Mask – 255.255.255.0 ● Default Gateway – 0.0.0.0
Dynamic Address (DHCP)	If your network uses the DHCP server, select this option. According to this setting, the camera will be assigned an IP address from the DHCP server automatically. Every time when the camera starts up, please make sure that the DHCP server is set to assign a static IP address to your camera.
PPPoE	If your application requires a direct connection from an ADSL modem through the camera's RJ-45 LAN port, click this option and enter the User ID and Password into the respective boxes. (<i>You should have an ISP PPPoE account.</i>) The camera will get an IP address from the ISP as starting up.

- **DNS IP Address:** DNS (Domain Name System) server is an Internet service that translates domain names into IP addresses. Enter at least one DNS IP Address in this field.
- **Dynamic DNS:** The Dynamic DNS service allows you to alias a dynamic IP address to a static hostname in any of the domains, allowing your computer to be more easily accessed from various locations on the Internet.
- **Second HTTP Port:** The default port for communication is via port 80, and you can change it according to your network configuration. Select **Enable** from the option and enter the desired port number in the following box.
- **UPnP:** UPnP is the architecture for pervasive peer-to-peer network connectivity of intelligent appliances, and PCs of all form factors. Check the **Enable** option to enable the function of your camera.

User

Click the **User** item in the left column to add, edit and delete users for your camera.

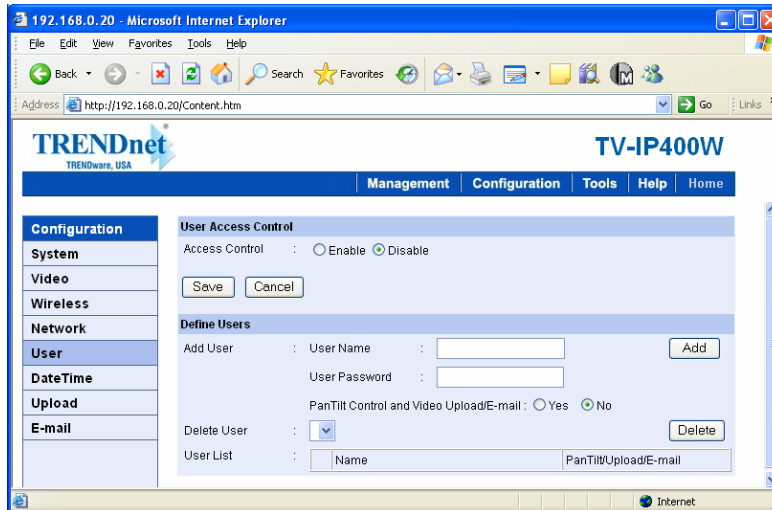

- User Access Control:

- **Access Control:** The administrator has the authority to give permission for the privilege to control the device to users by selecting *Enable* or *Disable*. The default setting is *No*.

- Define Users: Use this field to add or delete users for your camera.

- **Add User:** Enter the user name in this box, and enter the user's password assigned by the administrator. The maximum password length is **8** (printable ASCII). The administrator has the authority to give permission for the privilege to control the **Upload/E-mail Video** control to the users by selecting *Yes* or

No to activate the **Upload/E-mail Video**. To add a new user's name, enter the necessary information first and click the *Add* button.

- **Delete User:** Select the user you want to delete from the pull-down menu, and then click the *Delete* button.
- **User List:** This list displays the current users status of your camera.

DateTime

Click the **DateTime** item in the left column to setup time and date for your camera, providing correct information for the remote users who might be thousands of miles away from the camera's location.

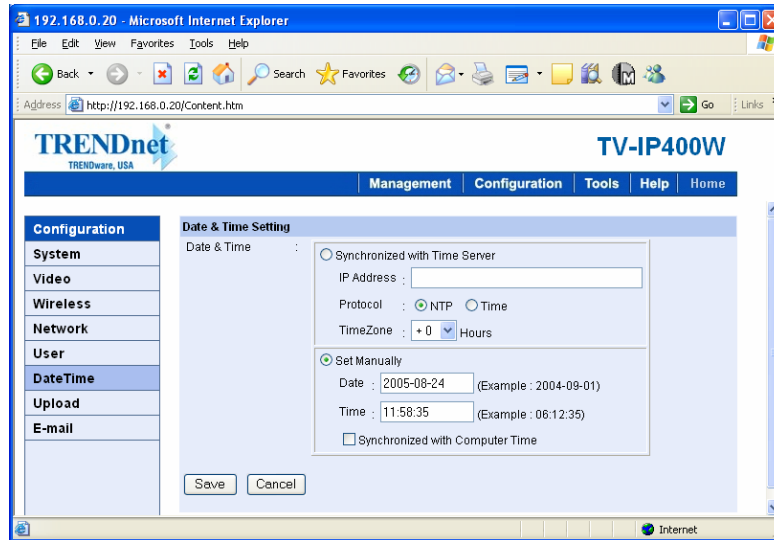

- **Date & Time:** You can set up time and date manually or automatically by selecting the *Synchronized with Time Server* option.

- **Synchronized with Time Server:** Select this option and the time will be based on GMT setting. The time will be synchronized every 10 minutes. When selecting this option, you have to enter the required information in the following fields:

IP Address	Enter the IP Address of the Time Server in this box.
Protocol	Two options of NTP or Time are available for your selection to link with the Time Server. The default setting is NTP.
TimeZone	Select the time zone for the region from the pull-down menu.

- **Set Manually:** Select this option to set the time manually. The system administrator must enter the date and time in the respective field manually.

Upload

Click the **Upload** item in the left column to setup configuration for FTP server, time schedule and manual operation.

TRENDnet TV-IP400W

Management Configuration Tools Help Home

Configuration

System

Video

Wireless

Network

User

DateTime

Upload

E-mail

FTP Server

Host Address :

Port Number : 21 (Default is 21)

User Name :

Password :

Directory Path :

Passive Mode : Yes No

Time Schedule

Time Schedule : Enable upload video to FTP server

Always

Schedule

Day : Mon Tue Wed Thu Fri Sat Sun

Time : Start: (Example : 06:30:00)

Period : Stop: (Example : 22:30:00)

Video Frequency : 1 Frames/Second

1 Seconds/Frame

Base File Name :

File : Overwrite

Date/Time Suffix

Sequence Number Suffix Up to 1024

Manual Operation

Manual Operation : Enable upload video to FTP server

Base File Name :

File : Overwrite

Date/Time Suffix

Sequence Number Suffix Up to 1024

Save Cancel

- **FTP Server:** This field contains the following six basic settings for your FTP server.

- **Host Address:** The IP Address of the target FTP server.
 - **Port Number:** The standard port number for the FTP server is Port **21**, and it's also the default setting. If the FTP server uses a specific port, please confirm the IT manager.
 - **User Name:** Enter the user name in this field.
 - **Password:** Enter the user password in this field to login the FTP server.
 - **Directory Path:** Enter an existing folder name in this field, and the images will be uploaded to the given folder.
 - **Passive Mode:** This function depends on your FTP server. Please check with your IT manager if the FTP server uses passive mode. The default setting is *No*.
- **Time Schedule:** Select the *Enable upload video to FTP server* option and enter the relevant information, such as the schedule, video frequency and base file name.
- **Schedule:** You can 1.) Choose *Always* to always upload the video to FTP server, or 2.) Set the *Schedule* to manage the uploading task. In the Schedule option, you can set the *Day* and *Time Period* option.
 - **Video Frequency:** There are two ways to set the video frequency: 1.) Set *Auto/1/2/3* frames per second, or 2.) Set the time in seconds for every frame.
 - **Base File Name:** Enter the file name to make sure that the images could be saved as the base file name.
 - **File:** Since you may not upload only one image to the FTP server, you can choose the filing rule, including

Overwrite, Date/Time Suffix, and set up the *Sequence Number*.

- **Manual Operation:** When you click the **Upload Video** button in view video screen, it will start to upload the image. The setting refers to **Base File Name** and **File** information above.

E-mail

Click the **E-mail** item in the left column to setup configuration for E-mail account, time schedule and manual operation settings.

The screenshot shows the configuration page for the TV-IP400W device. The interface includes a navigation menu on the left with options like System, Video, Wireless, Network, User, DateTime, Upload, and E-mail. The main content area is titled 'E-mail Account' and contains several sections: 'E-mail Account' with fields for SMTP Server Address, Sender e-mail Address, Receiver e-mail Address, User Name, and Password; 'Time Schedule' with a checkbox to 'Enable e-mail video to e-mail account', radio buttons for 'Always' and 'Schedule', and a time selection box with 'Start' and 'Stop' times and an 'Interval' of 300 seconds; and 'Manual Operation' with a checkbox to 'Enable e-mail video to e-mail account' and an 'Interval' of 300 seconds. At the bottom, there are 'Save' and 'Cancel' buttons.

- **E-mail Account:** This field contains the following six basic settings for your FTP server.

- **SMTP Server Address:** SMTP (Simple Mail Transfer Protocol) is a protocol for sending e-mail messages between servers you need to input the mail server address in this field.
 - **Sender e-mail Address:** Enter the e-mail address of the user who will send the e-mail.
 - **Receiver e-mail Address:** Enter the e-mail address of the user who will receive the e-mail.
 - **User Name:** Enter the user name in this field.
 - **Password:** Enter the user password in this field to login receiver's mail server.
-
- **Time Schedule:** Select the *Enable-mail video to e-mail account* option to set schedule to send e-mail. Please refer to the instruction in **Upload** section. The *Interval* option is to define time interval between two images sent.
 - **Manual Operation:** When you click the *E-mail Video* button in view video screen, it will start to e-mail image. The *Interval* option is to define time interval between two images sent.

System Administration → Tools

The **Tools** window contains commands for restarting the camera. Click **Tools** in the top menu bar and the Tools window will appear as below:

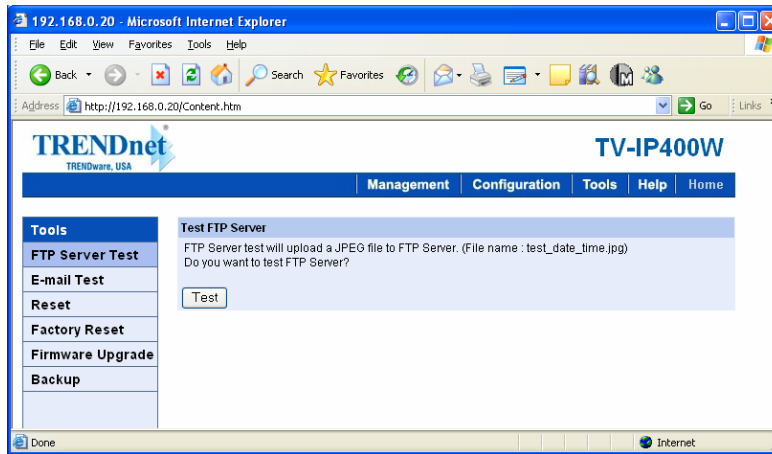

FTP Server Test

Click the **FTP Server Test** item in the left column to test your FTP server (as shown above).

- **Test FTP Server:** Click the *Test* button to test the FTP server you provided.

E-mail Test

Click the **E-mail Test** item in the left column to test your e-mail account.

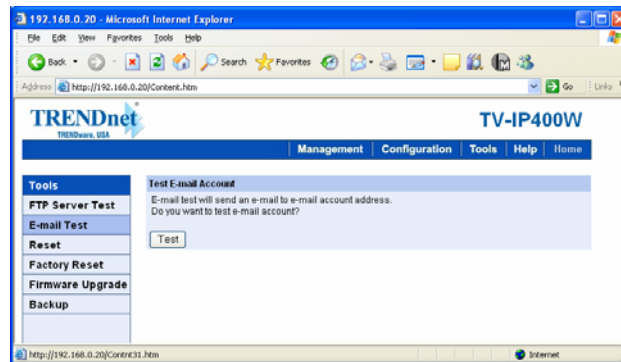

- **Test E-mail Account:** Click the *Test* button to test the e-mail account you provided.

Reset

Do you really want to reset this device? Click the *Yes* button from this option, and you can restart the camera just like turning the device off and on and saved settings are retained. If you do not want to reset the camera, exit this window without clicking *Yes*.

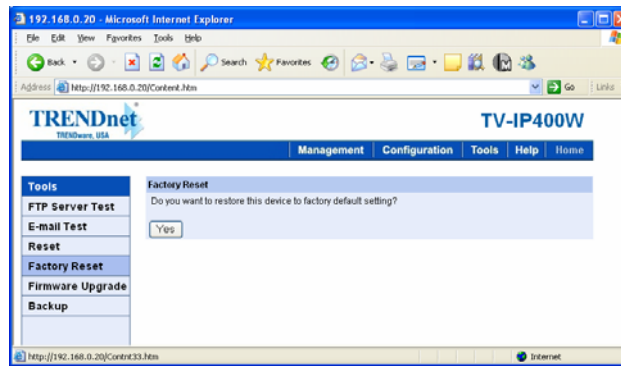

Factory Reset

Do you really want to factory reset this device? Click the *Yes* button from this option, and you can resume all factory default settings for the camera. If you do not want to restore the factory settings, exit this window without clicking *Yes*. Please NOTE that you have to configure the network settings again after a Factory Reset.

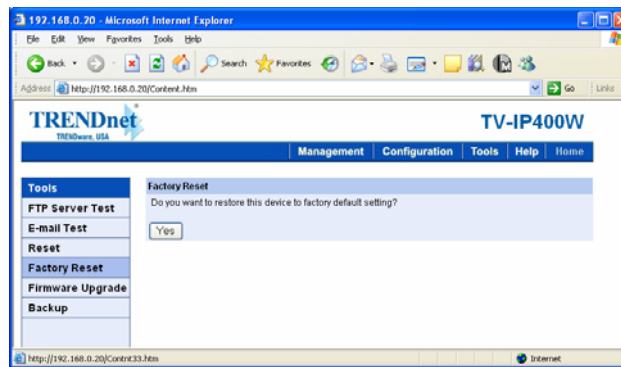

Firmware Upgrade

When new firmware is available, you can upgrade it through this window. Click the *Browse...* button to point to the firmware file, and then click *Update* to start upgrading.

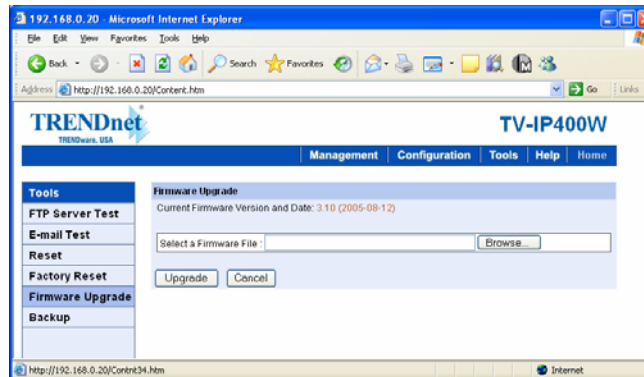

Backup

Click the **Backup** item in the left column to backup the current configuration.

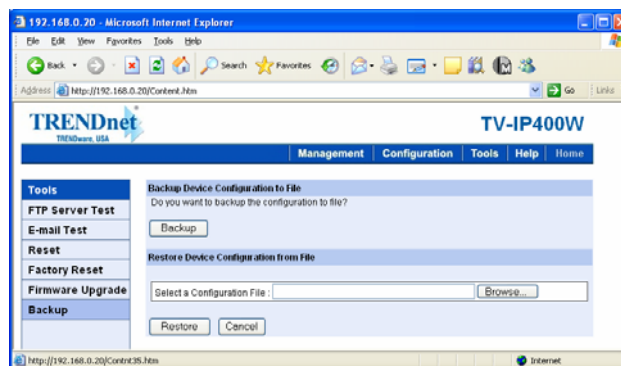

- **Backup Device Configuration to File:** Do you really want to backup the configuration to file? Click the *Backup* button from this option, and you can save the current configuration to file.
- **Restore Device Configuration from File:** You can resume the device configuration from saved file in the computer. Click the *Browse...* button to point to the file, and then click *Restore* to start restoring.

System Administration → Help

The **Help** window provides the basic information of the camera. Click **Help** in the top menu bar and the Help window will appear as below:

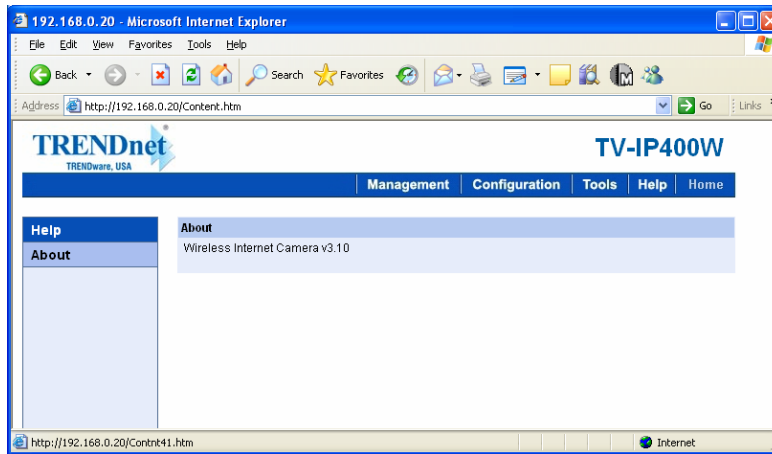

About

Displays the camera's model name and version.

Once the configuration is completed, click **Home** to return to the Welcome screen and select the desired View Video option either through **ActiveX Mode** or **Java Mode** as described in the next section.

Then, position the camera to the desired location appropriately for your purpose. Followed by adjustment of the camera focus, done manually by turning the lens clockwise or anti-clockwise to the

desire image quality. Please refer to *Appendix F* for detailed instruction.

Viewing Video

To view video images from the browser, click **View Video – ActiveX Mode** or **Java Mode** from the Welcome screen to access the video images from your browser.

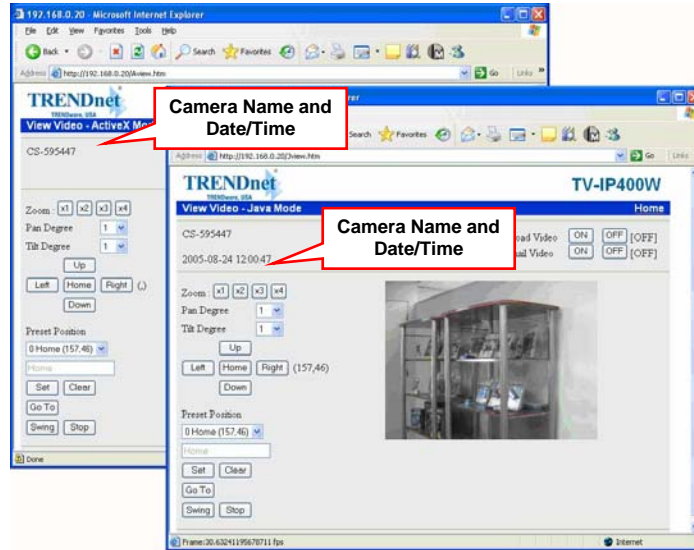

View Image – ActiveX Mode and Java Mode

Camera Name & Date/time: The Camera name and the current date/time will be displayed when the related information are entered under **Configuration** of Web Configuration Utility.

Uploading/E-mailing Video

In the **View Video – ActiveX Mode** or **Java Mode**, you are allowed to use the **Upload Video** and **E-mail Video** options. Simply click the desired selection *ON* or *OFF* to utilize the options for each of the functions.



Enable/Disable the Upload/E-mail Function

NOTE:

1. Please refer to the appendix on how to install ActiveX, including 1.) Install to the Web Server, and 2.) Install to your Local PC.

2. The administrator has the authority to set the upload/e-mail video function through the setting in the **Upload/E-mail** option under **Configuration**.

Controlling the Camera

You can control the camera's viewing angle through the control buttons on the left side of the viewing window.

The image shows a control panel for a camera. It includes the following elements:

- Zoom:** Four buttons labeled x1, x2, x3, and x4.
- Pan Degree:** A dropdown menu currently showing '1'.
- Tilt Degree:** A dropdown menu currently showing '1'.
- Navigation Buttons:** A central 'Up' button, a row of 'Left', 'Home', and 'Right' buttons, and a 'Down' button. The 'Right' button is followed by the coordinates '(157,46)'.
- Preset Position:** A dropdown menu showing '0 Home (157,46)'. Below it is a text input field containing the word 'Home'.
- Action Buttons:** 'Set' and 'Clear' buttons are positioned below the text input. Below those are 'Go To', 'Swing', and 'Stop' buttons.

Control buttons

Adjusting the Viewing Angle

To adjust the camera's viewing angle, simply click the *Up/Down/Left/Right* button. Then, you can easily move the camera's lens to focus on the object that you want. Clicking the *Home* button allows you return to the original position.

The Pan Degree and Tilt Degree options allow you to increase/decrease the changing range (1~10) when you click the buttons.

Storing the Position

You can store the position(s) that you want to monitor, so that you can quickly move the camera's lens to focus on the object that you want. You can store up to 24 positions in the camera (the number "0" is for default position "Home"). To store the current position, select the setting number (1~24) from the pull-down list, and then click *Set*. You can enter the name for the position in the following box.

To remove the stored position, select the position that you want to remove, and then click *Clear*.

When you have stored the position in the camera, select the number (position) from the pull-down list, and then click *Go To*. The camera's lens will move to the position immediately.

Swinging the Camera

The camera can swing automatically between the stored positions. Once you have stored two (or more) positions in the camera, click *Swing* will have the camera swing from one position to another position. Click *Stop* to stop swinging.

IPVIEW SE

This chapter describes the IPView SE, which is a powerful software application designed with a user-friendly interface for ease of control and navigation requirements.

Installation

Insert the CD-ROM into the CD-ROM drive to initiate the auto-run program. Once completed, a menu screen will appear as below:

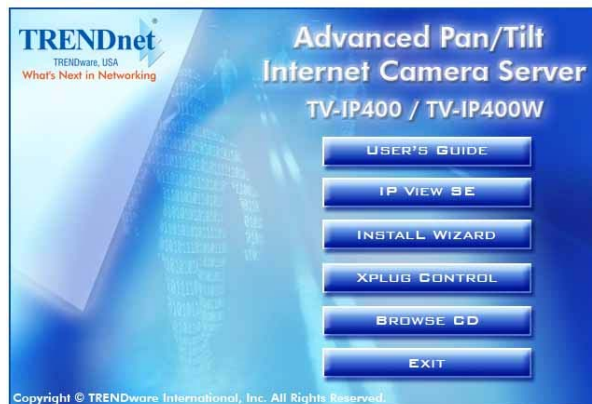

To install the IPView SE application, click the IPView SE item to activate the installation procedure for the application program.

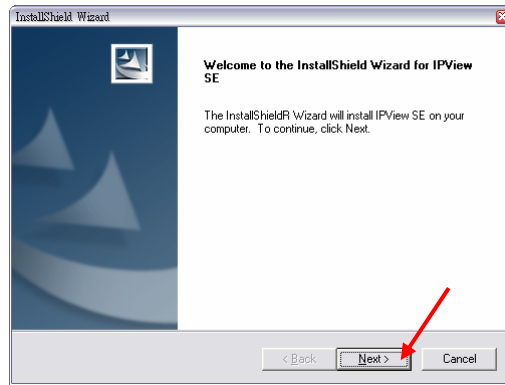

Click *Next* in the welcome screen of InstallShield Wizard.

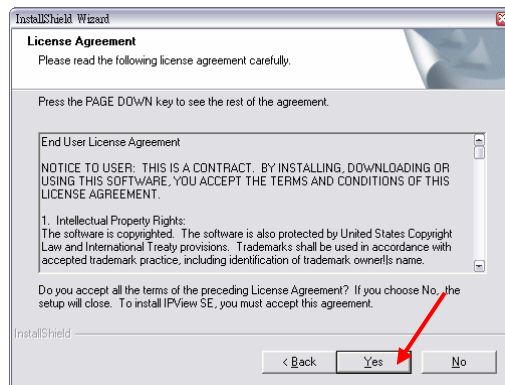

Read and accept the software's License Agreement; then, click *Yes*.

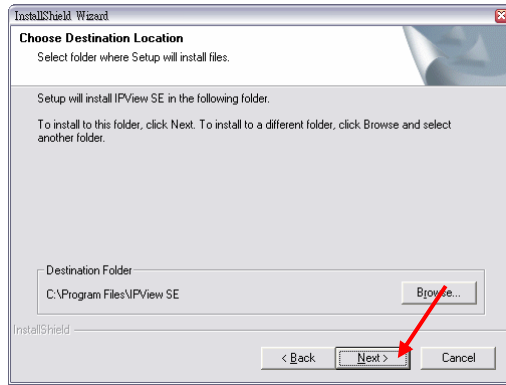

Choose the destination location. If no specific requirement, leave the default setting and click *Next*.

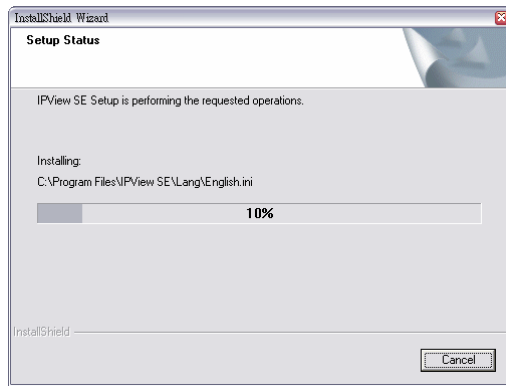

The InstallShield Wizard starts to install the software, and the progress bar indicates the installation is proceeding.



Windows® XP



Windows® 2000

If you use Windows® 2000/XP, it will appear a Digital Signature warning screen. Click *Continue Anyway* (Windows® XP) or *Yes* (Windows® 2000).

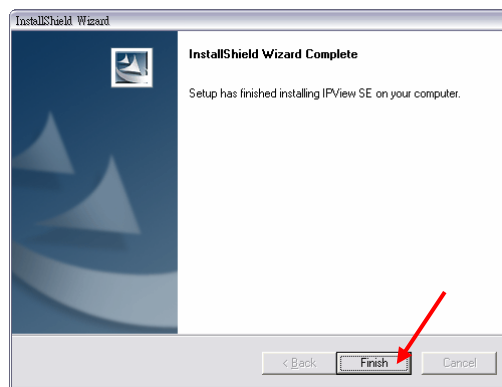

Click *Finish* to complete the installation.

After successfully installing the IPView SE, the application program for the camera is automatically installed to \Programs\Files directory.

To start running IPView SE, click **Start > Programs > IPView SE > IPView SE**.

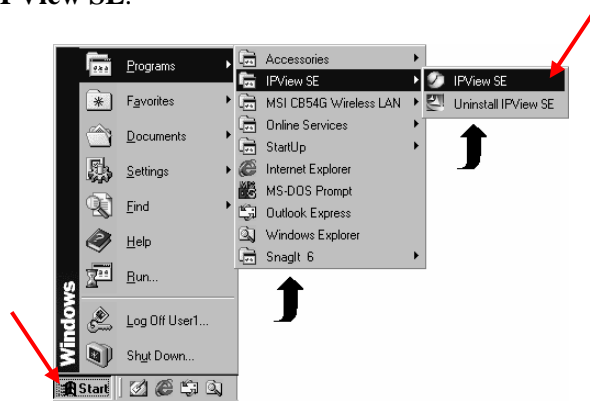

Once login, the IPView SE application is executed and the interface of IPView SE will appear in the default List View format as bellow:



Getting Started

IPView SE is responsible for the management of preview, configuration, and searching of each camera.

It is designed with a user-friendly interface for ease of control and navigation requirements as illustrated below.

IPView SE Control Panel

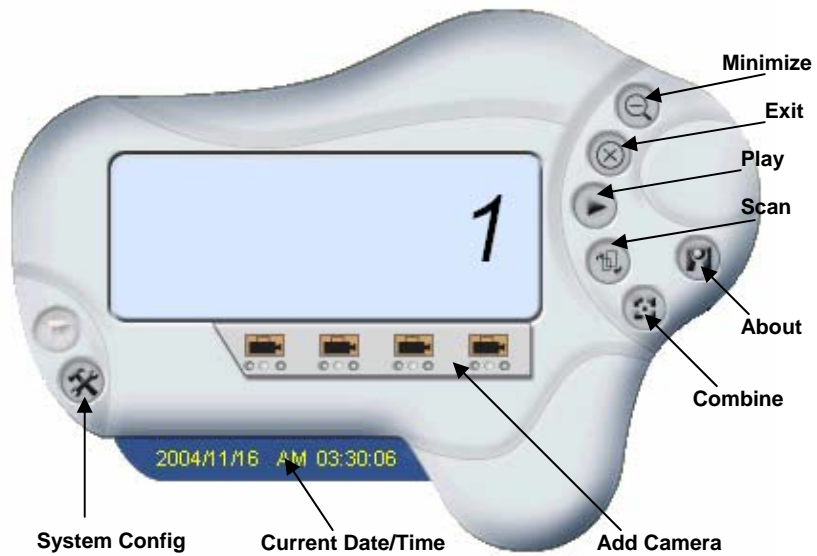

**Minimize**

To minimize the control panel.

**Exit**

To close IPView SE.

**Play**

To play back the recorded file.

**Scan**

To display for each camera one by one.

**Combine**

To combine all display windows in one.

**About**

To display the information of IPView SE.

How to Add a Camera

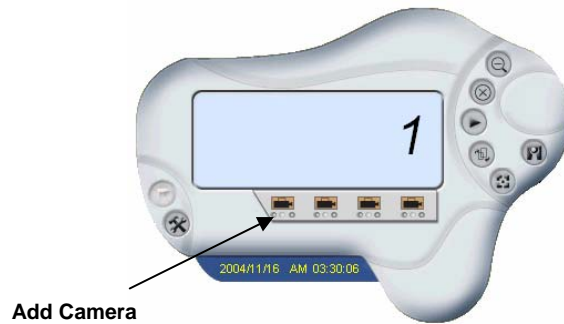
 **Add Camera**

To add a new camera, click the **Add Camera** button (1~4). An **Add Camera** dialog box will appear as illustrated below.

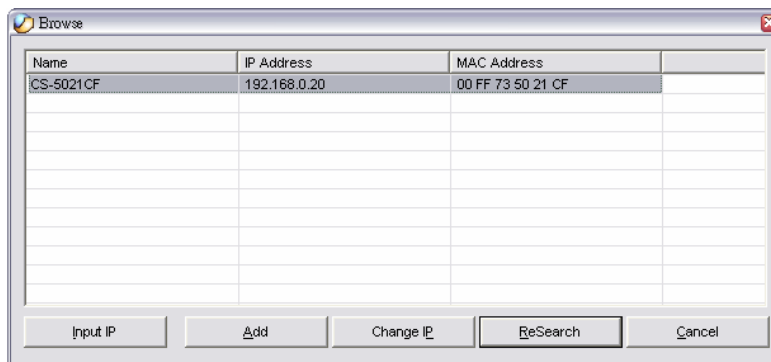

You must select the camera and click the *Add* button to add a new camera.

You can select the *Input IP* button, an **Input IP** dialog box will appear as illustrated below.

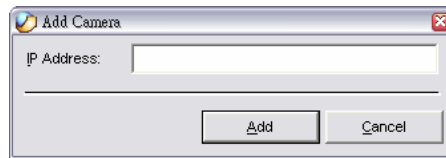

Enter the IP Address of the camera in the specified field and click the *Add* button to add a new camera.

Note:

1. If you want to add a camera through the Internet, you must key in a physical IP Address.
2. When the camera is installed behind Gateway and the Open Second Port of camera/Port Forwarding of Gateway function is enabled, the Gateway IP address has to be entered with the Port Number as below:

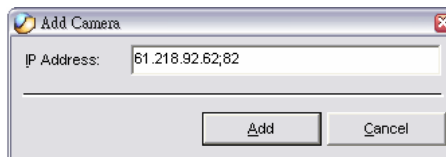

3. At the same time, the Gateway IP address can be replaced by URL as below:

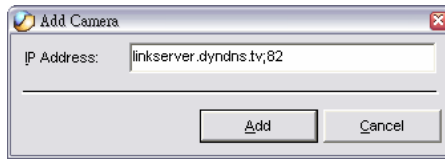

4. If you forget the IP Address that you want to add, a dialog box will appear to notify you of the error.



If you are unsure of the IP Address of the camera, you can click the *ReSearch* button, it will start searching the available camera(s) again, and display the result in the dialog box.

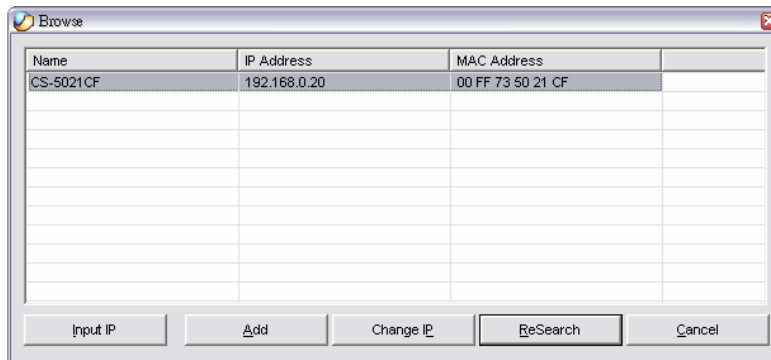

You must select the camera and click the *Add* button to add a new camera.

If the **Login Camera** dialog box appears, make sure to enter the correct **User Name** and **Password** and click the *OK* button. Then, the camera will be added into IPView SE in list format. If the **User Name** and **Password** is entered incorrectly, the camera will not be added into IPView SE.

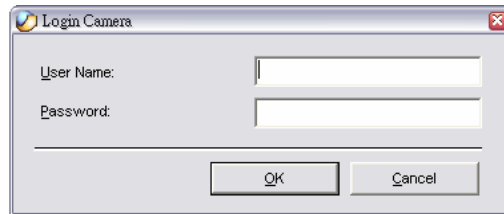

The above dialog box will appear only if administrator has already set up the **User Name** and **Password** in the Web Configuration setting.

If you forget to highlight the camera you want to add, a dialog box will appear to notify you of the error.

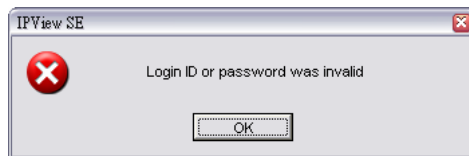

Make sure to save any changes you have made to keep the information updated.

Note :

You are allowed to add only one camera at a time.

When the user adds the camera, the additional control/configuration buttons will appear, including: Assign IP to Camera, Connect/Disconnect, Erase, Extra Information, etc. Also, the Pan/Tilt control buttons will appear on the Control Panel.



How to Change Camera



Assign IP of New Camera

To change camera, click the **Assign IP of Camera** button on the Control Panel. An **Assign IP of Camera** dialog box will appear as illustrated below.

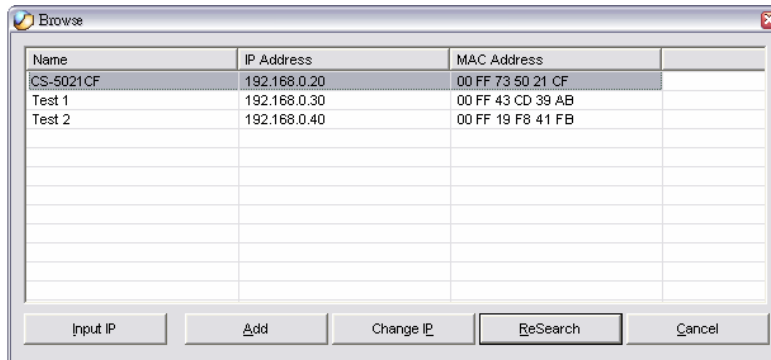

You must select the camera and click the **Add** button to add a new camera.

Connect/Disconnect the Image



Connect the Image

Click the **Connect/Disconnect** button and the preview screen will appear with the video image.



NOTE: When a new camera is added, it is connected. You can see the image right away. If you click the "Connect/Disconnect" button, it will be in disconnecting, also, no image showed.



Minimize

Click to minimize the display screen of the camera.



Maximize

Click to maximize the display screen of the camera.



Close

Click to close the display screen of the camera.



Always on top

Click to have the display screen always appear on the top of the window.



Wake up control panel

Click to open the control panel again when it is closed.



Color setting

Click to adjust color of the image.



View list

Click to check the event list of the camera.



Snapshot

Click to snapshot a picture from the camera.



Rotate image

Click to rotate the image of the camera.



Disconnect the Image

Click the **Connect/Disconnect** button, and the camera will be disconnected.

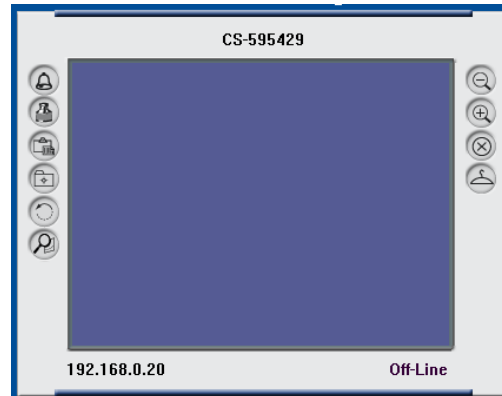

How to Delete a Camera

Liberate Camera

To delete a camera, you must select the camera to delete from the IPView SE control panel. Then, click the **Liberate Camera** button.

After deleting the camera, the IPView SE control panel will appear as below.



Extra Information

Extra Information

The screen displays the camera's information.

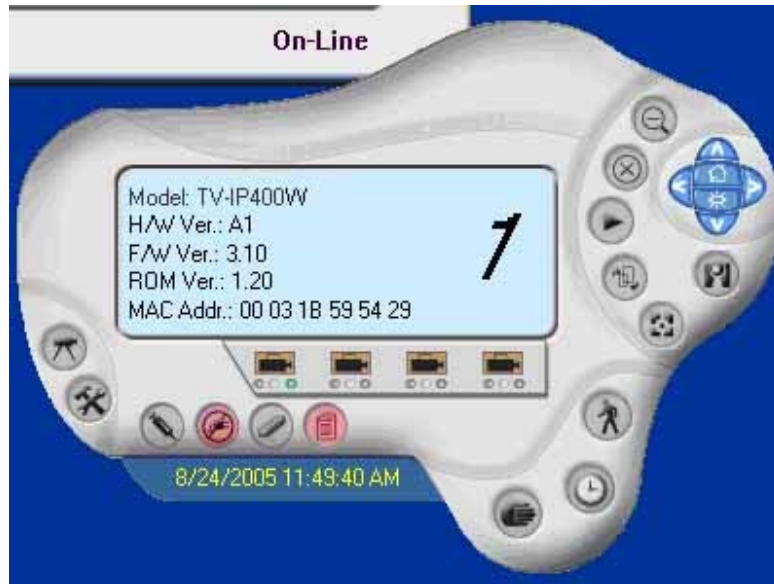

How to Adjust the Property Setting

System Configure

From the control panel, select the button and the dialog box will appear as shown below.

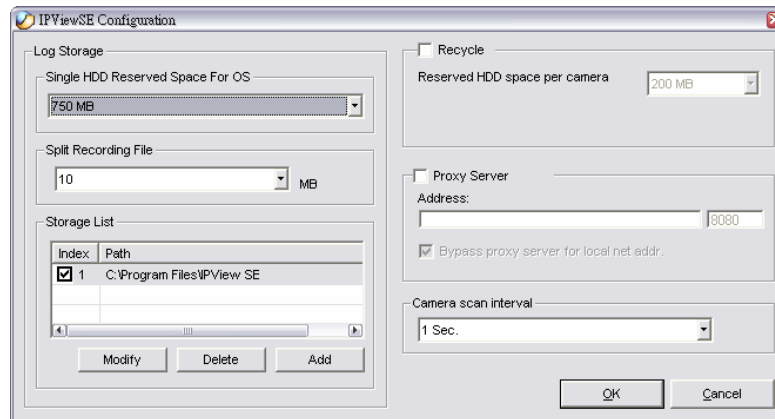

Log Storage:

1. Single HDD Reserve Space
This option permits reserved HDD space from 500 MB to 1000 MB.
2. Split Recording File
From this option, you can adjust the file size for recording the video images (the default setting is 10MB). If the recorded video files reach the file size, video images will be recorded into another file automatically.
By File Size - permits recording by file size from 10 MB to 50 MB.

3. Storage List

This option is used to define the path to save image files.

The software will create a camera name folder as the “Storage List” which is allowed to create up to 16 File Path.

Recycle:

When you enabled this function, it will recycle the HDD space once the disk space is less than the size defined. The size defined can be from 200 MB to 50000 MB.

Proxy Server:

Select this option to enable the Proxy Server support.

Camera Scan Delay:

It allows you to display for each camera one by one. The time interval for each camera can be from 1 Sec. to 20 Sec.



Camera Configure

Click the **Camera Config** button and it will activate the Camera Setting, Motion Setting and Update Firmware buttons.

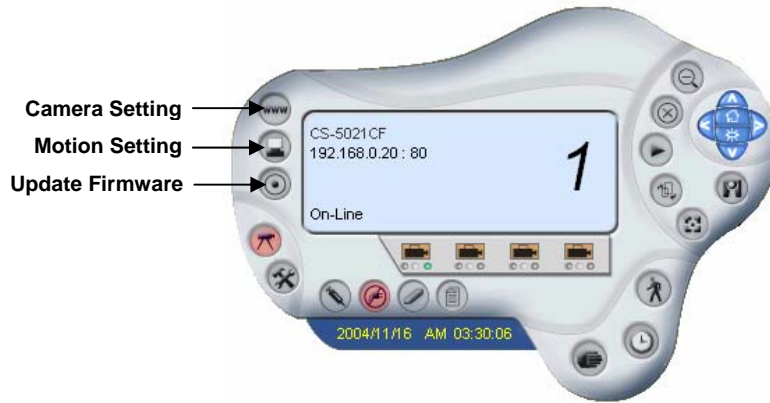

Camera Setting

Please refer to the “*Web Configuration*” section.



Motion Setting

You can adjust the sensitivity level and choose the Invoke Alarm options to work with motion detection function.

Besides the Alarm Beep, Send Email can be enabled when motion detected.

The user can define the time interval to Send E-mail.

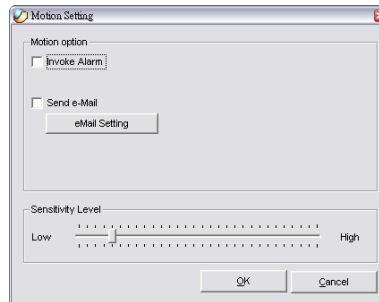

The Motion Setting dialog box contains the following elements:

- Motion option:** Two checkboxes, "Invoke Alarm" and "Send e-Mail", both of which are currently unchecked. Below the "Send e-Mail" checkbox is a button labeled "eMail Setting".
- Sensitivity Level:** A horizontal slider control with "Low" at the left end and "High" at the right end. A vertical tick mark is positioned approximately in the middle of the slider.
- Buttons:** "OK" and "Cancel" buttons at the bottom right.

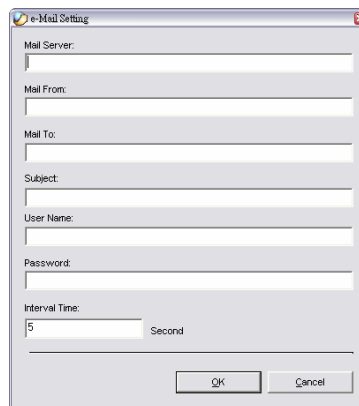

The e-Mail Setting dialog box contains the following elements:

- Mail Server:** A text input field.
- Mail From:** A text input field.
- Mail To:** A text input field.
- Subject:** A text input field.
- User Name:** A text input field.
- Password:** A text input field.
- Interval Time:** A text input field containing the number "5", followed by the label "Second".
- Buttons:** "OK" and "Cancel" buttons at the bottom right.

Mail Server: Mail Server IP or name.

Mail From: E-Mail Address of sender.

Mail To: E-Mail Address of receiver.

Subject: Can be any information to high light the message.

User Name: Enter the user name in this field.

Password: Enter the user password in this field to login receiver's mail server

Interval Time: The time interval to send next E-Mail the unit is by second.



Update Firmware

Enter the **File Path** and click the *Update* button, the firmware will be updated automatically.

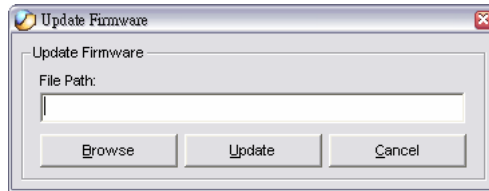

If you are unsure of the File path, you can click the *Browse* button, the **Browse** dialog box will appear, allowing you to find the file.

Warning

During firmware update process, please make sure no interruptions will occur as it might possibly cause serious damage to the Internet Camera.

Adjust the Recording Setting

There are three ways to start recording image - Motion Record, Schedule Record & Manual Record.



Motion Record

This option allows the camera to trigger recording by motion detected. You can adjust the sensitivity level and choose the warning options when motion is detected from motion setting.



Schedule Record

This option allows the camera to trigger recording as schedule defined. The schedule is set by date or weekday.



Manual Record

This option allows the camera to trigger recording manually.

APPENDIX

A. Frequently Asked Questions

Internet Camera Features

Q: What is an Internet Camera?

A: The camera is a standalone system connecting directly to an Ethernet or Fast Ethernet network and supported by the wireless transmission based on the IEEE 802.11g standard. It is different from the conventional PC camera, the camera is an all-in-one system with built-in CPU and web-based solutions providing a low cost solution that can transmit high quality video images for monitoring. The camera can be managed remotely, accessed and controlled from any PC/Notebook over the Intranet or Internet via a web browser.

Q: What is the maximum number of users that can be allowed to access the camera simultaneously?

A: Maximum number of users that can log onto the camera at the same time is 64. Please keep in mind the overall performance of the transmission speed will slow down when many users are logged on.

Q: What algorithm is used to compress the digital image?

A: The camera utilizes the JPEG image compression technology providing high quality images for users. JPEG is adopted since it is a standard for image compression and can be applied to various web browser and application software without the need to install extra software.

Q: Can I change the wireless antenna attached to the camera?

A: The wireless antenna can be changed for a variety of reasons such as extending the wireless transmission range, however, please consult authorized distributors before attempting as the connectors must be SMA connector type.

Q: What is the wireless transmission range for the camera?

A: Generally the wireless distance can go up to 100 meters indoors and up to 300 meters outdoors. The range is limited by the number of walls, ceilings, or other objects that the wireless signals must pass through. Typical ranges vary depends on the types of materials and background Radio Frequency (RF) noise in your home or business and the configuration setting of your network environment.

Internet Camera Installation

Q: Can the Internet Camera be used out-doors?

A: The camera is not weatherproof. It needs to be equipped with a weatherproof case to be used outdoors and it is not recommended.

Q: What network cabling is required for the camera?

A: The camera uses Category 5 UTP cable allowing 10 Base-T and 100 Base-T networking.

Q: Can the camera be setup as a PC-cam on the computer?

A: No, the camera is an Internet Camera used only on Ethernet and Fast Ethernet network and supported by wireless transmission.

Q: Can the camera be connected on the network if it consists of only private IP addresses?

A: The camera can be connected to LAN with private IP addresses.

Q: Can the camera be installed and work if a firewall exists on the network?

A: If a firewall exists on the network, port 80 is open for ordinary data communication. However, since the camera transmits image data, the default port 8481 is also required. Therefore, it is necessary to open port 8481 of the network for remote users to access the camera.

B. PING Your IP Address

The PING (Packet Internet Groper) command can determine whether a specific IP address is accessible by sending a packet to the specific address and waiting for a reply. It can also provide a very useful tool to confirm if the IP address conflicts with the camera over the network.

Follow the step-by-step procedure below to utilize the PING command. However, you must disconnect the camera from the network first.

Start a DOS window.

Type *ping x.x.x.x*, where *x.x.x.x* is the IP address of the camera.

The succeeding replies as illustrated below will provide useful explanation to the cause of the problem with the camera IP address.

C. Trouble Shooting

Q: I cannot access the camera from a web browser.

A1: The possible cause might be the IP Address for the camera is already being used by another device. To correct the possible problem, you need to first disconnect the camera from the network. Then run the PING utility (follow the instructions in Appendix B - PING Your IP Address).

A2: Another possible reason is the IP Address is located on a different subnet. To fix the problem, run the PING utility (follow the instructions in Appendix B - PING Your IP Address). If the utility returns “no response” or similar, the finding is probably correct, then you should proceed as follows:

In Windows 95/98/2000 and Windows NT, double check the IP Address of the camera is within the same subnet as your workstation.

Click “Start”, “Setting”, “Control Panel”, and the “Network” icon. Select TCP/IP from the “Network” dialog box and from the “TCP/IP Properties” dialog box click “Specify an IP address”.

If the camera is situated on a different subnet than your workstation, you will not be able to set the IP address from this workstation. To verify make sure the first 3 sections of the IP address of the camera corresponds to the first 3 sections of the workstation. Therefore the IP address of the camera must be set from a workstation on the same subnet.

A3: Other possible problems might be due to the network cable. Try replacing your network cable. Test the network interface of the product by connecting a local computer to the unit, utilizing a

standard Crossover (hub to hub) Cable. If the problem is not solved the camera might be faulty.

Q: Why does the Power LED not light up constantly?

A: The power supply used might be at fault. Confirm that you are using the provided power supply DC 5V for the camera and verify that the power supply is well connected.

Q: Why does the Link LED not light up properly?

A1: There might be a problem with the network cable. To confirm that the cables are working, PING the address of a know device on the network. If the cabling is OK and your network is reachable, you should receive a reply similar to the following (...bytes = 32 time = 2 ms).

A2: The network device utilized by the camera is not functioning properly such as hubs or switches. Confirm the power for the devices are well connected and functioning.

A3: The wireless connection might be at fault. In ad-hoc mode make sure the camera wireless channel and SSID are set to match the PC/Notebook wireless channel and SSID for direct communication.

Under infrastructure mode make sure the SSID on the PC/Notebook and the camera must match with the access point's SSID.

Q: Why does the camera work locally but not externally?

A1: Might be caused from the firewall protection. Need to check the Internet firewall with your system administrator.

A2: The default router setting might be a possible reason. Need to double check if the configuration of the default router settings is required.

Q: Why does a series of broad vertical white line appears through out the image?

A: A likely issue is that the CMOS sensor becomes overloaded when the light source is too bright such as direct exposure to sunlight or halogen light. You need to reposition the camera into a more shaded area immediately as this will damage the CMOS sensor.

Q: There is bad focus on the camera, what should be done?

A1: The focus might not be correctly adjusted for the line of sight. You need to adjust the camera focus manually as described in Adjust Internet Camera Focus.

A2: There is no adaptor fitted with your C-type lens. If you have previously changed the supplied CS-type lens, you may have unintentionally installed a C-type lens without fitting the adaptor first.

Q: Noisy images occur how can I solve the problem?

A1: The video images might be noisy if the camera is used in a very low light environment. To solve this issue you need more lighting.

A2: There might be wireless transmission interference make sure there are no other wireless devices on the network that will affect the wireless transmission.

Q: There is poor image quality, how can I improve the image?

A1: A probable cause might be the incorrect display properties configuration for your desktop. You need to open the Display Properties on your desktop and configure your display to show at least 65'000 colors for example at least 16-bit.

NOTE: *Applying only 16 or 256 colors on your computer will produce dithering artifacts in the image.*

A2: The configuration on the camera image display is incorrect. Through the Web Configuration Image section you need to adjust the image related parameter for improve images such as brightness, contrast, hue and light frequency. Please refer to the Web Configuration section for detail information.

Q: There are no images available through the web browser?

A: The ActiveX might be disabled. If you are viewing the images from Internet Explorer make sure ActiveX has been enabled in the Internet Options menu. Alternatively, you can use the Java Applet for viewing the required images.

D. Time Zone Table

(GMT-12:00) Eniwetok, Kwajalein
(GMT-11:00) Midway Island, Samoa
(GMT-10:00) Hawaii
(GMT-09:00) Alaska
(GMT-08:00) Pacific Time (US & Canada); Tijuana
(GMT-07:00) Arizona
(GMT-07:00) Mountain Time (US & Canada)
(GMT-06:00) Central Time (US & Canada)
(GMT-06:00) Mexico City, Tegucigalpa
(GMT-06:00) Saskatchewan
(GMT-05:00) Bogota, Lima, Quito
(GMT-05:00) Eastern Time (US & Canada)
(GMT-05:00) Indiana (East)
(GMT-04:00) Atlantic Time (Canada)
(GMT-04:00) Caracas, La Paz

(GMT-04:00) Santiago
(GMT-03:30) Newfoundland
(GMT-03:00) Brasilia
(GMT-03:00) Buenos Aires, Georgetown
(GMT-02:00) Mid-Atlantic
(GMT-01:00) Azores, Cape Verde Is.
(GMT) Casablanca, Monrovia
(GMT) Greenwich Mean Time : Dublin, Edinburgh, Lisbon, London
(GMT+01:00) Amsterdam, Berlin, Bern, Rome, Stockholm, Vienna
(GMT+01:00) Belgrade, Bratislava, Budapest, Ljubljana, Prague
(GMT+01:00) Brussels, Copenhagen, Madrid, Paris, Vilnius
(GMT+01:00) Sarajevo, Skopje, Sofia, Warsaw, Zagreb
(GMT+02:00) Athens, Istanbul, Minsk
(GMT+02:00) Bucharest
(GMT+02:00) Cairo

(GMT+02:00) Harare, Pretoria
(GMT+02:00) Helsinki, Riga, Tallinn
(GMT+02:00) Jerusalem
(GMT+03:00) Baghdad, Kuwait, Riyadh
(GMT+03:00) Moscow, St. Petersburg, Volgograd
(GMT+03:00) Nairobi
(GMT+03:30) Tehran
(GMT+04:00) Abu Dhabi, Muscat
(GMT+04:00) Baku, Tbilisi
(GMT+04:30) Kabul
(GMT+05:00) Ekaterinburg
(GMT+05:00) Islamabad, Karachi, Tashkent
(GMT+05:30) Bombay, Calcutta, Madras, New Delhi
(GMT+06:00) Astana, Almaty, Dhaka
(GMT+06:00) Colombo

(GMT+07:00) Bangkok, Hanoi, Jakarta
(GMT+08:00) Beijing, Chongqing, Hong Kong, Urumqi
(GMT+08:00) Perth
(GMT+08:00) Singapore
(GMT+08:00) Taipei
(GMT+09:00) Osaka, Sapporo, Tokyo
(GMT+09:00) Seoul
(GMT+09:00) Yakutsk
(GMT+09:30) Adelaide
(GMT+09:30) Darwin
(GMT+10:00) Brisbane
(GMT+10:00) Canberra, Melbourne, Sydney
(GMT+10:00) Guam, Port Moresby
(GMT+10:00) Hobart
(GMT+10:00) Vladivostok

(GMT+08:00) Singapore
(GMT+08:00) Taipei
(GMT+09:00) Osaka, Sapporo, Tokyo
(GMT+09:00) Seoul
(GMT+09:00) Yakutsk
(GMT+09:30) Adelaide
(GMT+09:30) Darwin
(GMT+10:00) Brisbane
(GMT+10:00) Canberra, Melbourne, Sydney
(GMT+10:00) Guam, Port Moresby
(GMT+10:00) Hobart
(GMT+10:00) Vladivostok
(GMT+11:00) Magadan, Solomon Is., New Caledonia
(GMT+12:00) Auckland, Wellington
(GMT+12:00) Fiji, Kamchatka, Marshall Is.

E. Xplug Control Installation

Installation To Web Server

Important Information

It is highly recommended to install the Xplug Control application to the Web Server for IE 5.0. It must be installed to a Public Domain with Fixed IP address.

1. Installation:

Copy the “xplug.ocx” file to any WEB Server table.

2. Setting (Configuration):

From the Web Configuration menu select “System” and under the “Loading ActiveX From” input web server location

(<http://www.web server location.com/>).

Once the settings are completed, the user now is able to access the Internet Camera from the web browser by selecting the image view – ActiveX mode.

Installation To Local PC

Insert the CD-ROM into the CD-ROM drive to initiate the auto-run program. Once completed, a menu screen will appear as below:

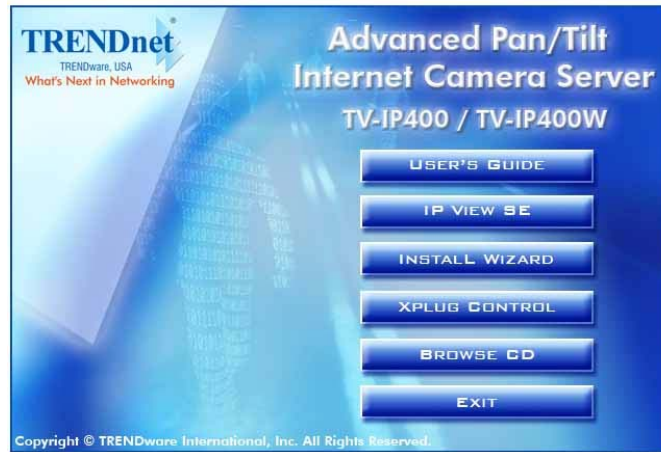

To install Xplug Control, click the **Xplug Control** item to activate the installation procedure for the plug-in program.

Once executed, a prompt will appear requesting the input of the desired language selection. Make the desired selection and click *OK* to continue.



The Welcome screen will appear. Click the *Next* button to proceed with the installation.

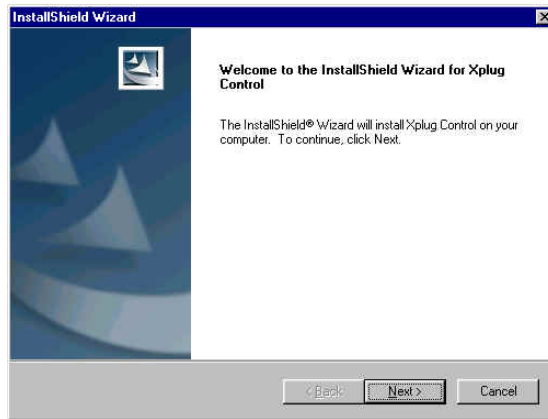

The License Agreement prompt will appear as below. Read the details carefully and click the *Yes* button to continue with the installation procedure.



Click the *Finish* button to complete Setup of the Xplug Control Utility program for the camera.

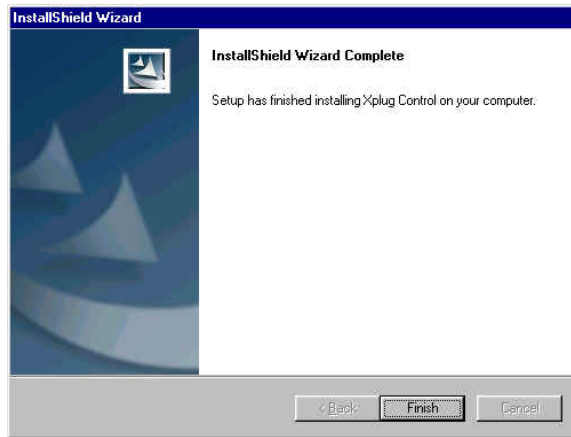

F. Adjust Internet Camera Focus

To adjust the focus of the lens, you need to turn the lens slowly in either clockwise or anti-clockwise direction until the desired image appears. DO NOT over turn the lens in either of the directions, as it will be out of focus.

NOTE: You can further adjust the camera's image quality through System Administration – Image of Web Configuration. Please refer to Web Configuration section for further details.

Warning

Direct exposure to sunlight may cause permanent damage to the CMOS sensor. Therefore do not expose the Internet Camera's lens directly to sunlight. When operation is required in glaring light environment, it is recommended to use an iris lens.

The Internet Camera is designed for indoor usage and if your application requires prolong exposure to sunlight, a sun visor is recommended to protect the Internet Camera.

G. Specification

Image Sensor

Sensor resolution	: 640 x 480 pixel
Sensor type	: 1/4" Color CMOS Sensor
Lens	: f: 6.0 mm, F: 1.8

Video

Image compression	: JPEG
Image Frame rate	: 30fps @ QQVGA, 25fps @ QVGA, 10fps @ VGA
Compression Rate selection	: 5 levels: Very low/Low/ Middle/High/Very high
Frame rate setting	: 1/5/7/15/20/Auto (depends on the video format)
Video resolution	: 160x120, 320x240, 640x480
Auto white balance	: Yes
Auto Exposure control	: Yes
Auto Gain control	: Yes
Left-Right /Up-Down reversal:	Yes

Hardware

LAN Connector	: One RJ-45 port, 10/100M auto- sensed, AutoMDIX
Wireless LAN	: Built-in 802.11g wireless LAN
Communication protocol	: HTTP, FTP, TCP/IP, UDP, ARP, ICMP, BOOTP, DHCP, PPPoE, DDNS, UPnP

CPU	: RDC R2880
RAM	: 8MB
Flash ROM	: 2MB
OS	: RTOS
Power Supply	: DC 5V 2.5A, switching type
Power consumption	: 8Watt (1600mA x 5V)
LED Indicator	: Power LED (Blue) Link LED (Orange)
Pan/Tilt	: Pan -156°~ +156° Tilt -45 ~ +70°

Software

Browser	: Internet Explorer 5.0 or above
Application Software	: IPView SE
OS supported	: Microsoft Windows 98SE/ME/ 2000/XP, Windows NT4.0

Operating Environment

Operating temperature:	5°C ~ 40°C
Storage temperature:	-25°C ~ 50°C
Humidity:	5% ~ 95%, non-condensing

EMI

FCC, CE, VCCI Class B

H. Glossary of Terms

NUMBERS

- 10BASE-T** 10BASE-T is Ethernet over UTP Category III,IV, or V unshielded twisted-pair media.
- 100BASE-TX** The two-pair twisted-media implementation of 100BASE-T is called *100BASE-TX*.
- 802.11g** An IEEE standard for wireless local area networks. It offers transmissions speeds at up to 54 Mbps in the 2.4-GHz band.

A

- Access point** It is the hardware interface between a wireless LAN and a wired LAN. The access point attaches to the wired LAN through an Ethernet connection.
- Applet** Applets are small Java programs that can be embedded in an HTML page. The rule at the moment is that an applet can only make an Internet connection to the computer from that the applet was sent.
- ASCII** American Standard Code For Information Interchange, it is the standard method for encoding characters as 8-bit sequences of binary numbers, allowing a maximum of 256 characters.

ARP Address Resolution Protocol. ARP is a protocol that resides at the TCP/IP Internet layer that delivers data on the same network by translating an IP address to a physical address.

AVI Audio Video Interleave, it is a Windows platform audio and video file type, a common format for small movies and videos.

B

BOOTP Bootstrap Protocol is an Internet protocol that can automatically configure a network device in a diskless workstation to give its own IP address.

C

Communication Communication has four components: sender, receiver, message, and medium. In networks, devices and application tasks and processes communicate messages to each other over media. They represent the sender and receivers. The data they send is the message. The cabling or transmission method they use is the medium.

Connection In networking, two devices establish a connection to communicate with each other.

D

DHCP Dynamic Host Configuration Protocol was developed by Microsoft a protocol for assigning dynamic IP

addresses to devices on a network. With dynamic addressing, a device can have a different IP address every time it connects to the network. In some systems, the device's IP address can even change while it is still connected. DHCP also supports a mix of static and dynamic IP addresses. This simplifies the task for network administrators because the software keeps track of IP addresses rather than requiring an administrator to manage the task. This means a new computer can be added to a network without the hassle of manually assigning it a unique IP address. DHCP allows the specification for the service provided by a router, gateway, or other network device that automatically assigns an IP address to any device that requests one

DNS

Domain Name System is an Internet service that translates domain names into IP addresses. Since domain names are alphabetic, they're easier to remember. The Internet however, is really based on IP addresses every time you use a domain name the DNS will translate the name into the corresponding IP address. For example, the domain name *www.network_camera.com* might translate to *192.167.222.8*.

E

Enterprise network

An enterprise network consists of collections of networks connected to each other over a geographically dispersed area. The enterprise network serves the needs of a widely distributed company and operates the company's mission-critical applications.

Ethernet The most popular LAN communication technology. There are a variety of types of Ethernet, including 10 Mbps (traditional Ethernet), 100 Mbps (Fast Ethernet), and 1,000 Mbps (Gigabit Ethernet). Most Ethernet networks use Category 5 cabling to carry information, in the form of electrical signals, between devices. Ethernet is an implementation of CSMA/CD that operates in a bus or star topology.

F

Fast Ethernet Fast Ethernet, also called 100BASE-T, operates at 10 or 100Mbps per second over UTP, STP, or fiber-optic media.

Firewall Firewall is considered the first line of defense in protecting private information. For better security, data can be encrypted. A system designed to prevent unauthorized access to or from a private network. Firewalls are frequently used to prevent unauthorized Internet users from accessing private networks connected to the Internet, especially Intranets all messages entering or leaving the intranet pass through the firewall, which examines each message and blocks those that do not meet the specified security criteria.

G

Gateway A gateway links computers that use different data formats together.

Group Groups consist of several user machines that have similar characteristics such as being in the same department.

H

HEX Short for hexadecimal refers to the base-16 number system, which consists of 16 unique symbols: the numbers 0 to 9 and the letters A to F. For example, the decimal number 15 is represented as F in the hexadecimal numbering system. The hexadecimal system is useful because it can represent every byte (8 bits) as two consecutive hexadecimal digits. It is easier for humans to read hexadecimal numbers than binary numbers.

I

IEEE Institute of Electrical and Electronic Engineers.

Intranet This is a private network, inside an organization or company, that uses the same software you will find on the public Internet. The only difference is that an Intranet is used for internal usage only.

Internet The Internet is a globally linked system of computers that are logically connected based on the Internet Protocol (IP). The Internet provides different ways to access private and public information worldwide.

Internet address To participate in Internet communications and on Internet Protocol-based networks, a node must have an Internet address that identifies it to the other nodes. All Internet addresses are IP addresses

IP Internet Protocol is the standard that describes the layout of the basic unit of information on the Internet (the *packet*) and also details the numerical addressing

format used to route the information. Your Internet service provider controls the IP address of any device it connects to the Internet. The IP addresses in your network must conform to IP addressing rules. In smaller LANs, most people will allow the DHCP function of a router or gateway to assign the IP addresses on internal networks.

IP address IP address is a 32-bit binary digit number that identifies each sender or receiver of information that is sent in packets across the Internet. For example 80.80.80.69 is an IP address, it is the closest thing the Internet has to telephone numbers. When you “call” that number, using any connection methods, you get connected to the computer that “owns” that IP address.

ISP Internet Service Provider, is a company that maintains a network that is linked to the Internet by way of a dedicated communication line. An ISP offers the use of its dedicated communication lines to companies or individuals who can't afford the high monthly cost for a direct connection.

J

JAVA Java is a programming language that is specially designed for writing programs that can be safely downloaded to your computer through the Internet without the fear of viruses. It is an object-oriented multi-thread programming best for creating applets and applications for the Internet, Intranet and other complex, distributed network.

L

LAN Local Area Network a computer network that spans a relatively small area sharing common resources. Most LANs are confined to a single building or group of buildings.

N

NAT Network Address Translator generally applied by a router, that makes many different IP addresses on an internal network appear to the Internet as a single address. For routing messages properly within your network, each device requires a unique IP address. But the addresses may not be valid outside your network. NAT solves the problem. When devices within your network request information from the Internet, the requests are forwarded to the Internet under the router's IP address. NAT distributes the responses to the proper IP addresses within your network.

Network A network consists of a collection of two or more devices, people, or components that communicate with each other over physical or virtual media. The most common types of network are:
LAN – (local area network): Computers are in close distance to one another. They are usually in the same office space, room, or building.
WAN – (wide area network): The computers are in different geographic locations and are connected by telephone lines or radio waves.

NWay Protocol A network protocol that can automatically negotiate the highest possible transmission speed between two devices.

P

PING Packet Internet Groper, a utility used to determine whether a specific IP address is accessible. It functions by sending a packet to the specified address and waits for a reply. It is primarily used to troubleshoot Internet connections.

PPPoE Point-to-Point Protocol over Ethernet. PPPoE is a specification for connecting the users on an Ethernet to the Internet through a common broadband medium, such as DSL or cable modem. All the users over the Ethernet share a common connection.

Protocol Communication on the network is governed by sets of rules called protocols. Protocols provide the guidelines devices use to communicate with each other, and thus they have different functions. Some protocols are responsible for formatting and presenting and presenting data that will be transferred from file server memory to the file server's network adapter Others are responsible for filtering information between networks and forwarding data to its destination. Still other protocols dictate how data is transferred across the medium, and how servers respond to workstation requests and vice versa. Common network protocols responsible for the presentation and formatting of data for a network operating system are the Internetwork Packet Exchange (IPX) protocol or the Internet Protocol (IP). Protocols that dictate the format of data

for transfers the medium include token-passing and Carrier Sense Multiple Access with Collision Detection (CSMA/CD), implemented as token-ring, ARCNET, FDDI, or Ethernet. The Router Information Protocol (RIP), a part of the Transmission Control Protocol/Internet Protocol (TCP/IP) suite, forwards packets from one network to another using the same network protocol.

R

- RARP** Reverse Address Resolution Protocol, a TCP/IP protocol that allows a physical address, such as an Ethernet address, to be translated into an IP address.
- RJ-45** RJ-45 connector is used for Ethernet cable connections.
- Router** A router is the network software or hardware entity charged with routing packets between networks.

S

- Server** It is a simple computer that provides resources, such as files or other information.
- SMTP** The Simple Mail Transfer Protocol is used for Internet mail.
- SNMP** Simple Network Management Protocol. SNMP was designed to provide a common foundation for managing network devices.

Station In LANs, a station consists of a device that can communicate data on the network. In FDDI, a station includes both physical nodes and addressable logical devices. Workstations, single-attach stations, dual-attach stations, and concentrators are FDDI stations.

Subnet mask In TCP/IP, the bits used to create the subnet are called the subnet mask.

T

(TCP/IP) Transmission Control Protocol/Internet Protocol is a widely used transport protocol that connects diverse computers of various transmission methods. It was developed by the Department of Defense to connect different computer types and led to the development of the Internet.

Transceiver A transceiver joins two network segments together. Transceivers can also be used to join a segment that uses one medium to a segment that uses a different medium. On a 10BASE-5 network, the transceiver connects the network adapter or other network device to the medium. Transceivers also can be used on 10BASE-2 or 10BASE-T networks to attach devices with AUI ports.

U

UDP The User Datagram Protocol is a connectionless protocol that resides above IP in the TCP/IP suite

ULP	The upper-layer protocol refers to Application Layer protocols such as FTP,SNMP, and SMTP.
User Name	The USERNAME is the unique name assigned to each person who has access to the LAN.
Utility	It is a program that performs a specific task.
UTP	Unshielded twisted-pair. UTP is a form of cable used by all access methods. It consists of several pairs of wires enclosed in an unshielded sheath.
 W	
WAN	Wide-Area Network. A wide-area network consists of groups of interconnected computers that are separated by a wide distance and communicate with each other via common carrier telecommunication techniques.
Windows	Windows is a graphical user interface for workstations that use DOS.
Workgroup	A workgroup is a group of users who are physically located together and connected to the same LAN, or a group of users who are scattered throughout an organization but are logically connected by work and are connected to the same network group.
Workstations	Workstation refers to the intelligent computer on the user's desktop. This computer may be an Intel-based PC, a Macintosh, or a UNIX-based workstation. The workstation is any intelligent device a user works from.

Limited Warranty

TRENDware warrants its products against defects in material and workmanship, under normal use and service, for the following lengths of time from the date of purchase.

Internet Camera Server – 3 Years Warranty

If a product does not operate as warranted above during the applicable warranty period, TRENDware shall, at its option and expense, repair the defective product or part, deliver to customer an equivalent product or part to replace the defective item, or refund to customer the purchase price paid for the defective product. All products that are replaced will become the property of TRENDware. Replacement products may be new or reconditioned.

TRENDware shall not be responsible for any software, firmware, information, or memory data of customer contained in, stored on, or integrated with any products returned to TRENDware pursuant to any warranty.

There are no user serviceable parts inside the product. Do not remove or attempt to service the product by any unauthorized service center. This warranty is voided if (i) the product has been modified or repaired by any unauthorized service center, (ii) the product was subject to accident, abuse, or improper use (iii) the product was subject to conditions more severe than those specified in the manual.

Warranty service may be obtained by contacting TRENDware office within the applicable warranty period for a Return Material Authorization (RMA) number, accompanied by a copy of the dated proof of the purchase. Products returned to TRENDware must be pre-authorized by TRENDware with RMA number

marked on the outside of the package, and sent prepaid, insured and packaged appropriately for safe shipment.

WARRANTIES EXCLUSIVE: IF THE TRENDWARE PRODUCT DOES NOT OPERATE AS WARRANTED ABOVE, THE CUSTOMER'S SOLE REMEDY SHALL BE, AT TRENDWARE'S OPTION, REPAIR OR REPLACEMENT. THE FOREGOING WARRANTIES AND REMEDIES ARE EXCLUSIVE AND ARE IN LIEU OF ALL OTHER WARRANTIES, EXPRESSED OR IMPLIED, EITHER IN FACT OR BY OPERATION OF LAW, STATUTORY OR OTHERWISE, INCLUDING WARRANTIES OF MERCHANTABILITY AND FITNESS FOR A PARTICULAR PURPOSE. TRENDWARE NEITHER ASSUMES NOR AUTHORIZES ANY OTHER PERSON TO ASSUME FOR IT ANY OTHER LIABILITY IN CONNECTION WITH THE SALE, INSTALLATION MAINTENANCE OR USE OF TRENDWARE'S PRODUCTS.

TRENDWARE SHALL NOT BE LIABLE UNDER THIS WARRANTY IF ITS TESTING AND EXAMINATION DISCLOSE THAT THE ALLEGED DEFECT IN THE PRODUCT DOES NOT EXIST OR WAS CAUSED BY CUSTOMER'S OR ANY THIRD PERSON'S MISUSE, NEGLIGENCE, IMPROPER INSTALLATION OR TESTING, UNAUTHORIZED ATTEMPTS TO REPAIR OR MODIFY, OR ANY OTHER CAUSE BEYOND THE RANGE OF THE INTENDED USE, OR BY ACCIDENT, FIRE, LIGHTNING, OR OTHER HAZARD.

LIMITATION OF LIABILITY: TO THE FULL EXTENT ALLOWED BY LAW TRENDWARE ALSO EXCLUDES FOR ITSELF AND ITS SUPPLIERS ANY LIABILITY, WHETHER BASED IN CONTRACT OR TORT (INCLUDING NEGLIGENCE), FOR INCIDENTAL, CONSEQUENTIAL, INDIRECT, SPECIAL, OR PUNITIVE DAMAGES OF ANY KIND, OR FOR LOSS OF REVENUE OR PROFITS, LOSS OF BUSINESS, LOSS OF INFORMATION OR DATA, OR OTHER FINANCIAL LOSS

ARISING OUT OF OR IN CONNECTION WITH THE SALE, INSTALLATION, MAINTENANCE, USE, PERFORMANCE, FAILURE, OR INTERRUPTION OF THE POSSIBILITY OF SUCH DAMAGES, AND LIMITS ITS LIABILITY TO REPAIR, REPLACEMENT, OR REFUND OF THE PURCHASE PRICE PAID, AT TRENDWARE'S OPTION. THIS DISCLAIMER OF LIABILITY FOR DAMAGES WILL NOT BE AFFECTED IF ANY REMEDY PROVIDED HEREIN SHALL FAIL OF ITS ESSENTIAL PURPOSE.

Governing Law: This Limited Warranty shall be governed by the laws of the state of California.

AC/DC Power Adapter, Cooling Fan, and Power Supply carry 1 Year Warranty



Product Warranty Registration

Please take a moment to register your product online.
Go to TRENDware's website at <http://www.TRENDNET.com>

TRENDnet Technical Support

US/Canada Support Center

Contact

Telephone: 1(310) 626-6252
Fax: 1(310) 626-6267
Email: support@trendnet.com

Tech Support Hours

7:30am - 6:00pm Pacific Standard Time
Monday - Friday

European Support Center

Contact**Telephone**

Deutsch : +49 (0) 6331 / 268-460
Français : +49 (0) 6331 / 268-461
08-00-90-71-61 (numéro vert)
Español : +49 (0) 6331 / 268-462
English : +49 (0) 6331 / 268-463
Italiano : +49 (0) 6331 / 268-464
Dutch : +49 (0) 6331 / 268-465
Fax: +49 (0) 6331 / 268-466

Tech Support Hours

8:00am - 6:00pm Middle European Time
Monday - Friday

TRENDware International, Inc.
3135 Kashiwa Street. Torrance, CA 90505
<http://www.TRENDNET.com>