

**User's Guide**

**TRENDNET<sup>®</sup>**



**Megapixel Wireless Day/Night Network Camera**

**TV-IP562WI**

## Contents

<b>Product Overview</b> .....	<b>2</b>
Package Contents .....	2
Features .....	2
Product Hardware Features .....	3
Wall mount installation .....	4
<b>Using the Autorun Wizard</b> .....	<b>4</b>
Option A: Wired Connection by Using a Network Cable .....	5
Option B: Connect Camera to Wireless Network by WPS Button .....	9
Option C: Manually Connect Camera to Wireless Network .....	13
<b>Mobile Apps</b> .....	<b>17</b>
<b>Setup Wizard (Finding IP address of the cameras)</b> .....	<b>18</b>
<b>Web Browser Management</b> .....	<b>22</b>
Main Web User Interface .....	24
Setup.....	26
<b>Wizard</b> .....	<b>26</b>
Step 1: LAN Settings .....	27
Step 2: Internet Settings .....	27
Step 3: DDNS Settings .....	27
Step 4: Camera Name Settings.....	28
Step 5: Time Settings.....	28
Step 6: Setup Complete.....	29
<b>System</b> .....	<b>30</b>
Admin .....	30
Time and Date .....	32
<b>Network</b> .....	<b>33</b>
Network .....	33

Wireless Setup .....	34
Dynamic DNS.....	35
<b>Audio/Video</b> .....	<b>36</b>
Audio and Video.....	36
Image Setup .....	38
<b>Action</b> .....	<b>39</b>
Recording .....	39
Video Clip .....	43
Snapshot .....	45
SD Management .....	47
<b>Motion Detection</b> .....	<b>48</b>
<b>Sound Detection</b> .....	<b>48</b>
<b>Tools</b> .....	<b>49</b>
System.....	49
Firmware Update .....	50
<b>Advanced</b> .....	<b>50</b>
Device Info .....	50
Log.....	51
<b>TRENDnetVIEW Pro Software</b> .....	<b>52</b>
<b>How to setup/access the camera remotely</b> .....	<b>53</b>
<b>Troubleshooting</b> .....	<b>56</b>

## Product Overview



**TV-IP562WI**

## Package Contents

- TV-IP562WI
- Multi-Language Quick Installation Guide
- CD-ROM (Utility & User's Guide)
- Network cable (1.8m/6ft)
- Power adapter (5V DC, 1A) (1.5m / 5ft)
- Camera mounting kit

If any package contents are missing or damaged, please contact the retail store, online retailer, or reseller/distributor that the item was purchased.

## Features

The Megapixel Wireless Day/Night Network Camera, model TV-IP562WI, provides megapixel night vision in complete darkness for up to 5 meters (16 feet). A mounting bracket and Wireless N networking support a variety of installations. Each camera comes with a free Apple® and Android™ mobile app and Complimentary pro-grade software to manage up to 32 TRENDnet cameras **Easy Installation**

### Wireless N

Wireless N network increases installation options

### HD Video

Experience high definition 720p HD video quality

### Night Vision

Night vision up to 5 meters (16 ft.) in complete darkness

### Digital Zoom

Zoom in by a factor of four

### Motion Detection Emails

Receive snapshots and video clips of motion via email

### Mounting Hardware

Mounting bracket supports upside down installation

### Two-Way Audio

Hear sounds from the camera (install a third party speaker for two-way audio)

### Storage

Store video to a network storage device or Micro SD card (up to 32 GB sold separately)

### Free Apps

See live video on a mobile device with free Apple® and Android™ apps

### Complimentary Software

Complimentary pro-grade software to manage up to TRENDnet 32 cameras

## Product Hardware Features

### Front Panel View



- **Micro SD Slot** – Insert a micro SD card into this slot to store video/image data.
- **Mounting Stand** – Portable adjustable stand.
- **IR Light Sensor** – Detects the light source to turn IR on or off.
- **IR LED** – Built-in IR LED for night vision use.
- **Camera Lens** – Fixed lens. The camera adjusts automatically.
- **Microphone** – Built-in microphone for audio can be turned on or off.

### Rear Panel View



- **Power Port** – Connect the included power adapter from your camera to an available power outlet. **Note:** Use only the adapter that came with your camera.
- **Speaker** – Insert an external active speaker.
- **WPS LED** – This LED indicator is solid blue when your camera is powered on. If this LED indicator is off, there is no power to your camera. This LED indicator is blinking green when there is connection/data to your camera.
- **WPS Button** – Press this button to enable WPS.
- **Power/Link LED** – This LED indicator is solid blue when your camera is powered on. If this LED indicator is off, there is no power to your camera. This LED indicator is blinking green when there is connection/data to your camera.
- **Reset Button** – Use an item such as a paperclip to push and hold this button for 6 seconds and release to reset your camera to its factory defaults.
- **Network Port** – Connect Network cables from the camera to your route or switch.

## Wall mount installation

To wall mount the camera, please following the steps below.

- Use the pencil to mark the three holes of the plate on the wall.
- Drill the holes
- Attached the camera to the plate
- Use the supplied screws to secure the camera stand to the wall.

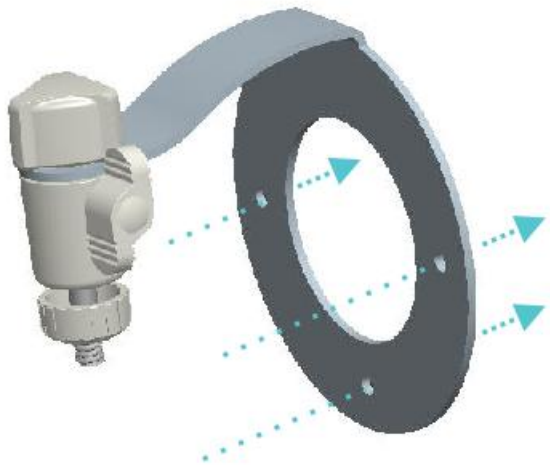

## Using the Autorun Wizard

The Autorun supports both Windows & Mac operating systems. Insert the Installation CD-ROM into your computer's CD-ROM drive to initiate the Autorun program. The Autorun Wizard program will run automatically.

**For Windows users:** If the autorun wizard does not run, go to the CD-ROM folder and run Autorun.exe to start installation wizard.



Autorun.exe

**For Mac users:** Please click **InstallWizard** to start installation wizard.

1. Select your desired language for Installation. There are five languages available – **English, French, German, Spanish, and Russian.**

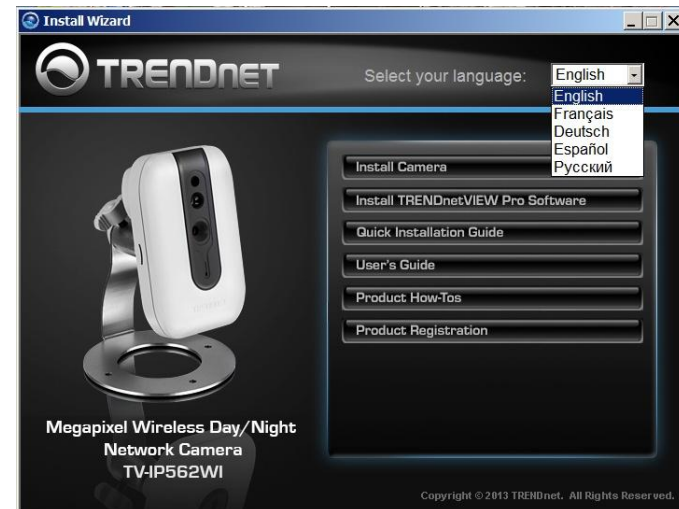

- Click **Install Camera** and follow the on-screen steps to continue the installation.



- Write down the MAC address of your camera. This can be found on the device label. Click **Next** to continue, **Back** to go to the previous screen or **Home** to return to the main menu. The packaging also included a sticker with the same information.



- The most important part of the setup process is the network connection type. There are three options:
  - Connect the camera to your network using a network cable
  - Connect the camera to your wireless network using Wi-Fi Protected Setup (WPS) button (Verify your router has a WPS button. If not, select the next option).
  - Connect the camera to your wireless network manually.

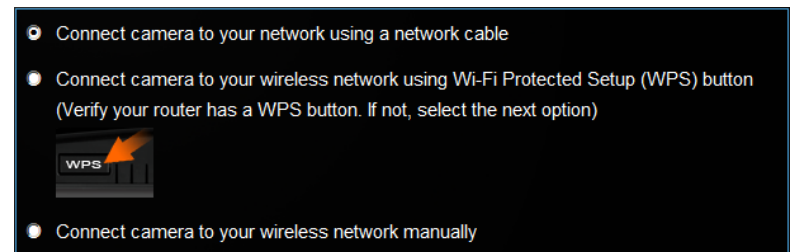

### Option A: Wired Connection by Using a Network Cable

- Click **Connect camera to your network using a network cable**. Click **Next** to continue.

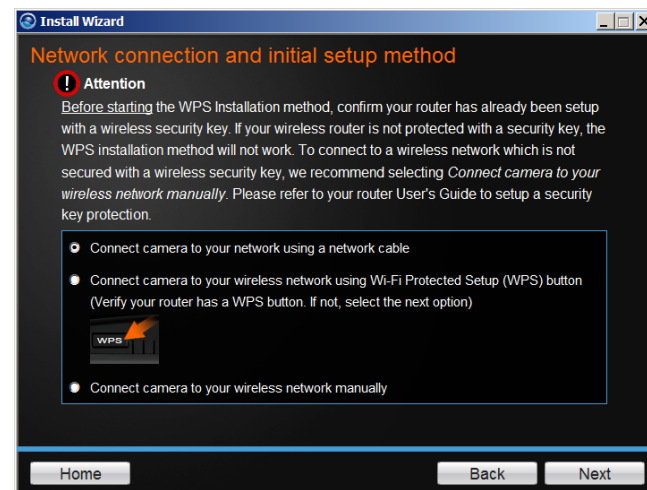

- 2. Connect one end of the included power adapter to the camera and the other end to the power outlet. The Power/Link LED will be blinking. Click **Next** to continue.

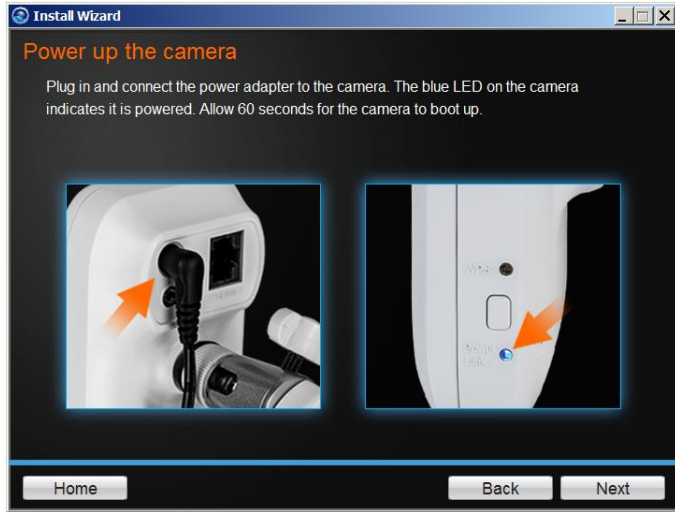

- 3. Connect one end of the network cable to your camera and the other end to your router. Click **Next** to continue.

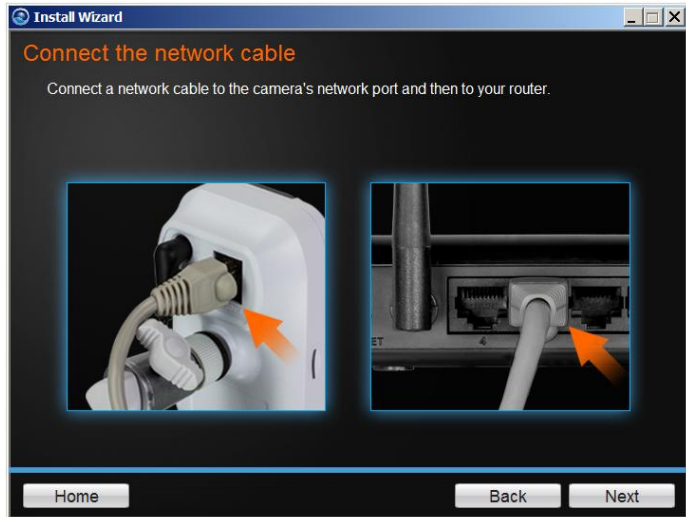

- 5. The wizard will search the network for your camera.

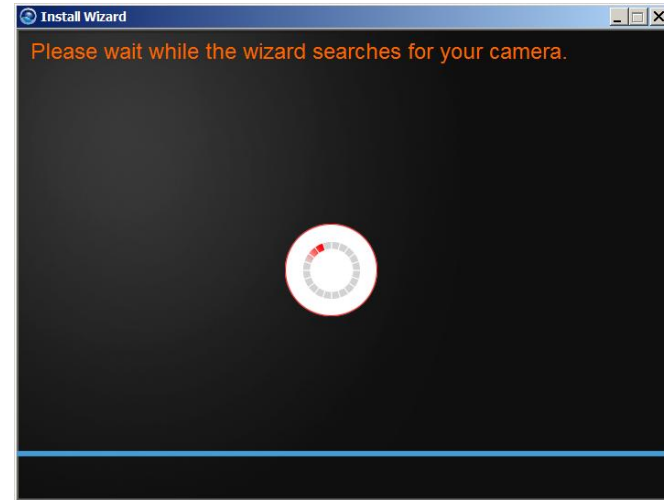

- 6. **Select your camera.** The wizard will show all cameras in the network. If there is only one camera in the network, the wizard will automatically select it. The wizard provides the **Model Name** and **MAC Address** of the camera. If you do not see any of your camera(s) in the wizard, click **Retry** to scan the camera again. Click **Next** to continue.

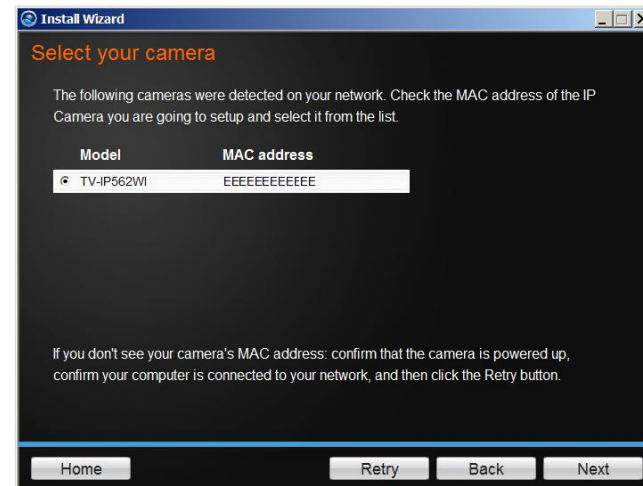

7. **Change Password.** The default username and password is **admin**. Tick the **Change Password** checkbox to enter the new password details. The password should be between 8 and 30 characters. Click **Next** to continue.



**Note:**

If you enter the incorrect admin details, you will be prompted to change the configuration, as shown below.

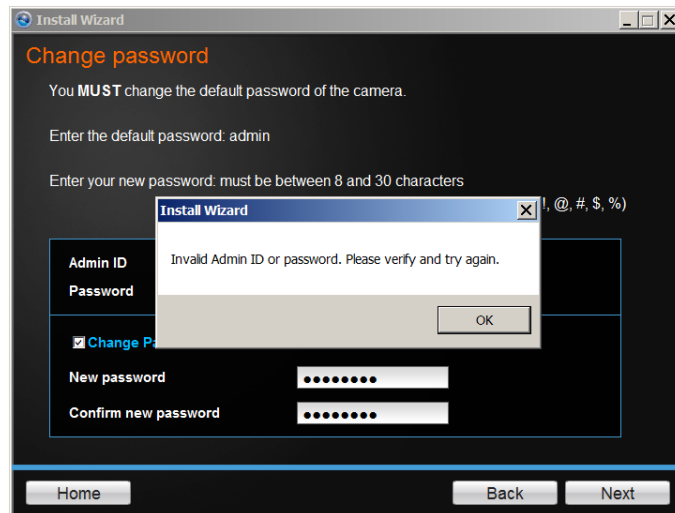

If the password length is less than 8 characters, you will also be prompted to alter the configuration, as shown below.

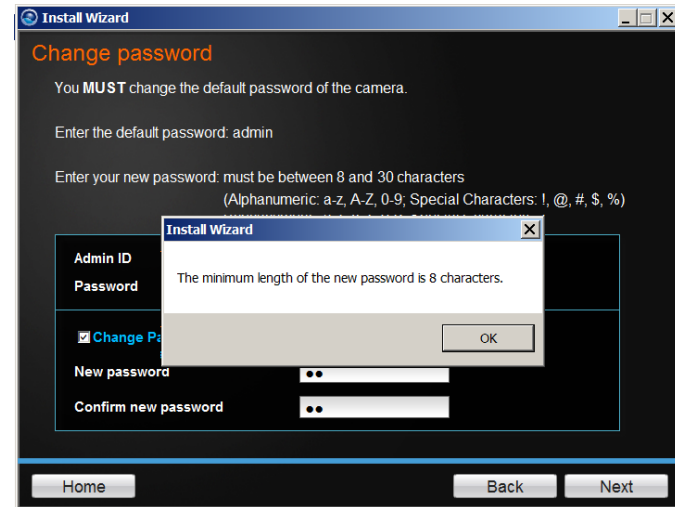

8. The wizard will configure your parameters.

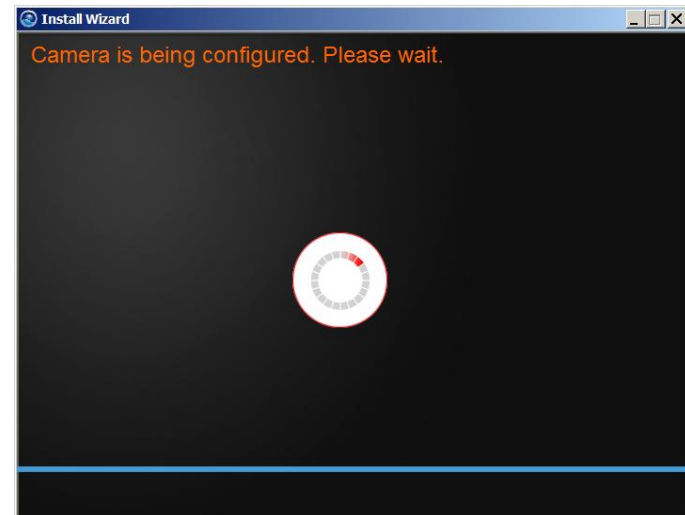



9. The initial setup is complete. Click the link to navigate to the camera's Web User Interface for further configuration or click product image to create a shortcut. Click **Next** to continue.

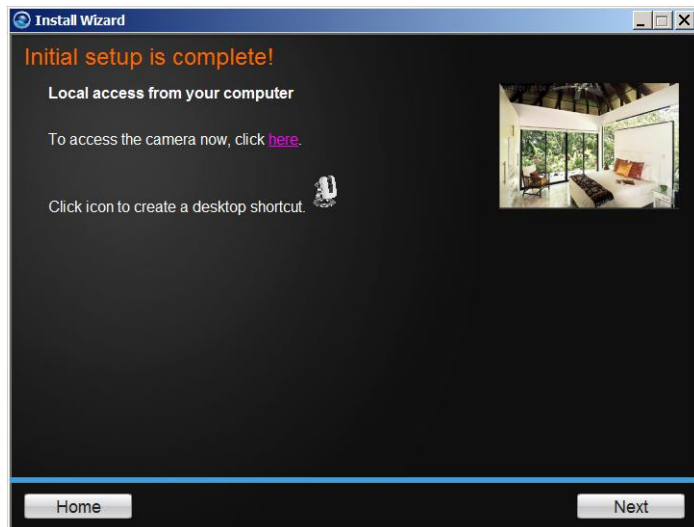

10. Scan the barcode to download the **TRENDnetVIEW App** for Apple iOS or Android™<sup>1</sup> devices. The app can also be found by searching TRENDnet from the Apple App Store or Google Play™<sup>2</sup>.

Please refer to the **Mobile Apps** section for additional app features information.

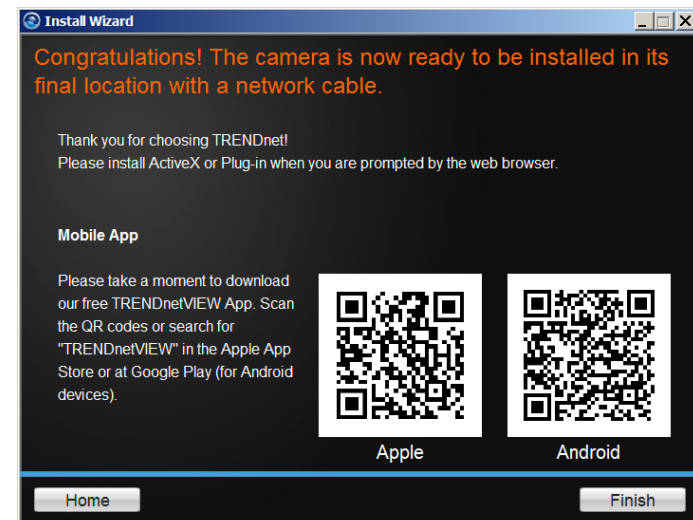

You are now ready to use your camera. Click **Finish** to exit.

<sup>1</sup> Android is a trademark of Google Inc.

<sup>2</sup> Google Play is a trademark of Google Inc.

## Option B: Connect Camera to Wireless Network by WPS Button

1. Click **Connect camera to your wireless using Wi-Fi Protected Setup (WPS) button** radio button.

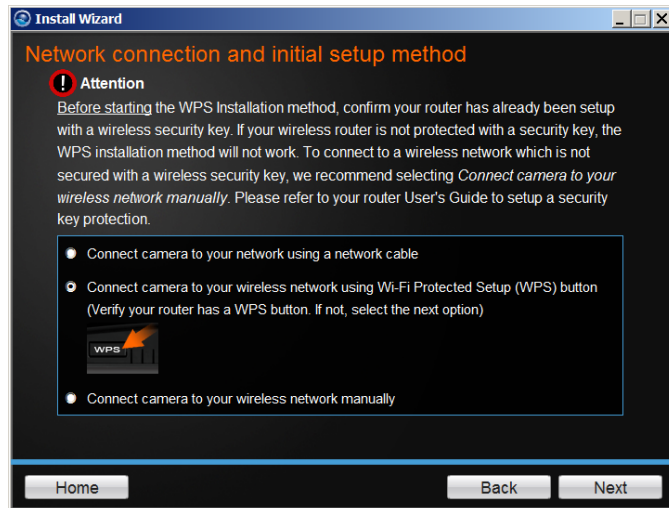

Please consider these points before using WPS.

- Find the access point (AP) or wireless router you wish to connect to from the **Available AP** drop down menu.
- In most cases you should leave the **Channel** set to **Auto** as the AP will determine the channel of operation.
- Select the type of **authentication** and **encryption** required by the access point and enter the **Key** required to connect.

Click **Next** to continue, **Back** to go to the previous screen or **Home** to return to the **Main Menu**.

2. Follow the instructions on the screen to **Power up the Camera**. Click **Next** to continue.



- Press the WPS button on your wireless router or access point for 5 seconds. Within 2 minutes press and hold WPS button on the IP Camera for 5 seconds. The WPS button will start blinking. Wait until the WPS LED turns off and Power/Link LED turn green. It can take up to 2 minutes for the camera to connect to the wireless router or access point. Click **Next** to continue. If you wish to go to the previous screen, click **Back** or click **Home** to return to the main menu.



- The wizard will now search for your camera.

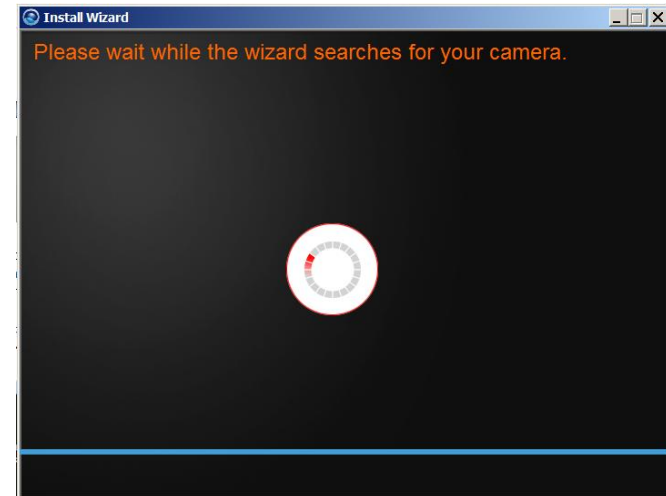

- Select your camera.** The wizard will show all cameras in the network. If there is only one camera in the network, the wizard will automatically select it. The wizard provides the **Model Name** and **MAC Address** of the camera. If you do not see any of your camera(s) in the wizard, click **Retry** to scan the camera again. Click **Next** to continue.



- 6. **Change Password.** The default username and password is **admin**. Tick the **Change Password** checkbox to enter the new password details. The password should be between 8 and 30 characters. Click **Next** to continue.



**Note:**

If you enter the incorrect admin details, you will be prompted to change the configuration, as shown below.

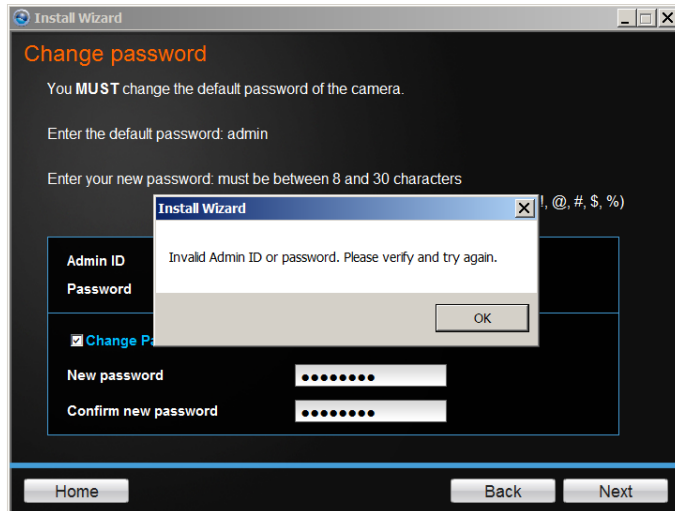

If the password length is less than 8 characters, you will also be prompted to alter the configuration, as shown below.

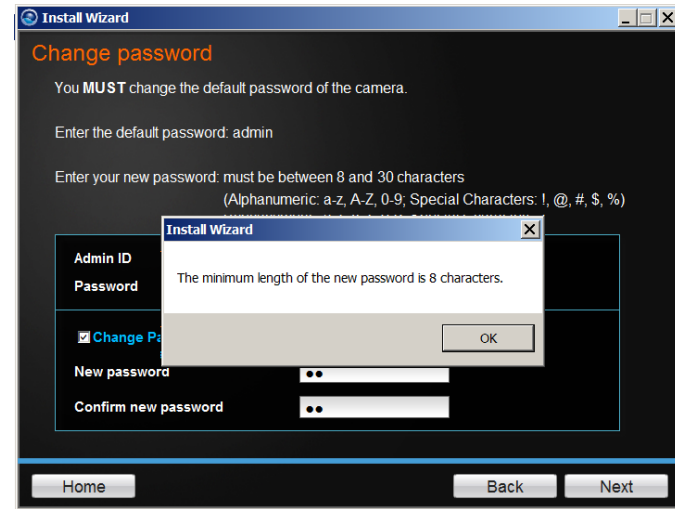

- 7. The wizard will configure your parameters.

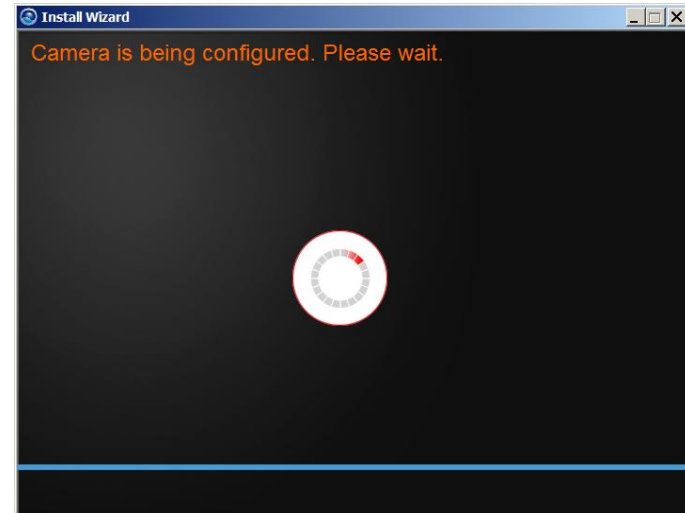

8. The initial setup is complete. Click the link to navigate to the camera's Web User Interface for further configuration or click product image to create a shortcut. Click **Next** to continue.

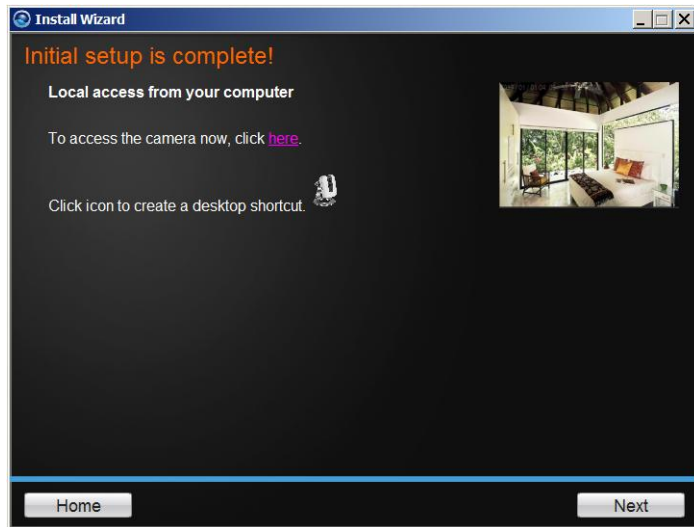

9. Scan the barcode to download the **TRENDnetVIEW App** for Apple iOS or Android™<sup>3</sup> devices. The app can also be found by searching TRENDnet from the Apple App Store or Google Play™<sup>4</sup>.

Please refer to the **Mobile Apps** section for additional app features information.

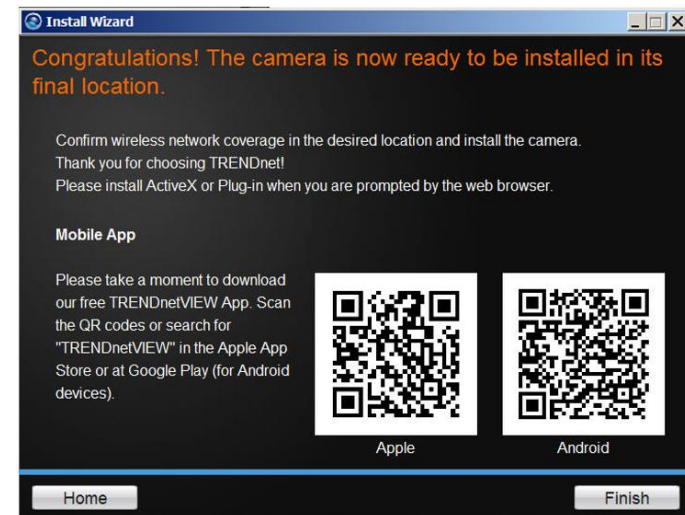

You are now ready to use your camera. Click **Finish** to exit.

<sup>3</sup> Android is a trademark of Google Inc.

<sup>4</sup> Google Play is a trademark of Google Inc.

## Option C: Manually Connect Camera to Wireless Network

1. Click **Connect camera to your wireless network manually** button

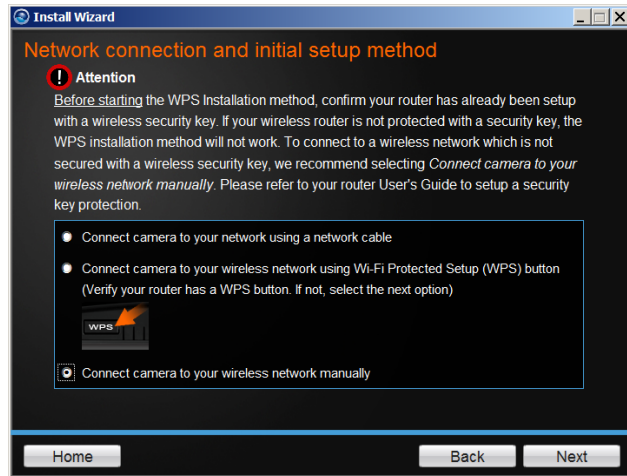

2. Follow the instructions in the next screen to **Power up the Camera**. Click **Next** to continue.

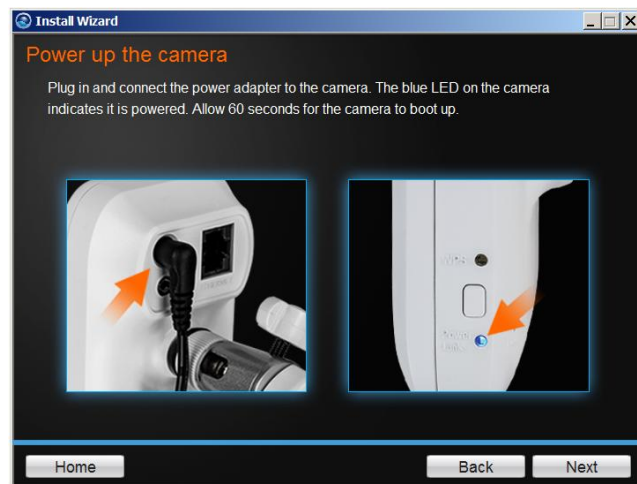

3. Connect one end of the network cable to your camera and the other end to your router. Click **Next** to continue, **Back** to go to the previous screen or **Home** to return to the **Main Menu**.

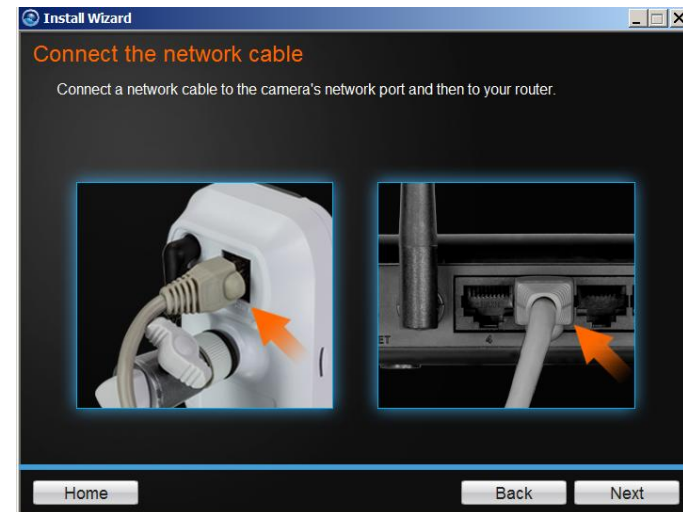

4. The wizard will now search the network for your camera.

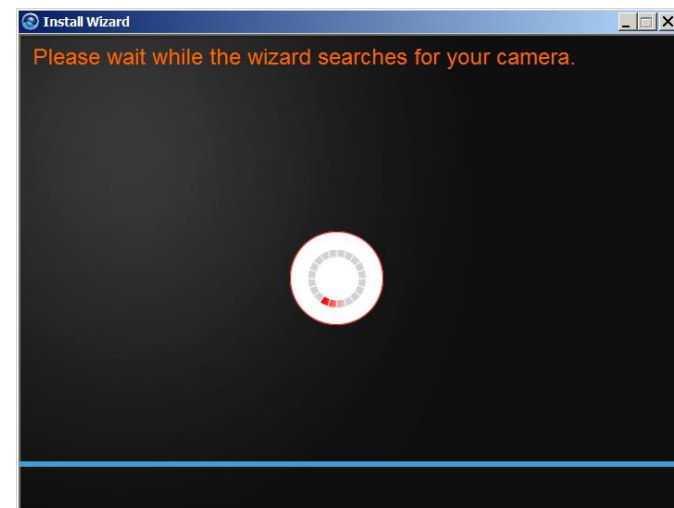

- 5. **Select your camera.** The wizard will show all cameras in the network. If there is only one camera in the network, the wizard will automatically select it. The wizard provides the **Model Name** and **MAC Address** of the camera. If you do not see any of your camera(s) in the wizard, click **Retry** to scan the camera again. Click **Next** to continue.

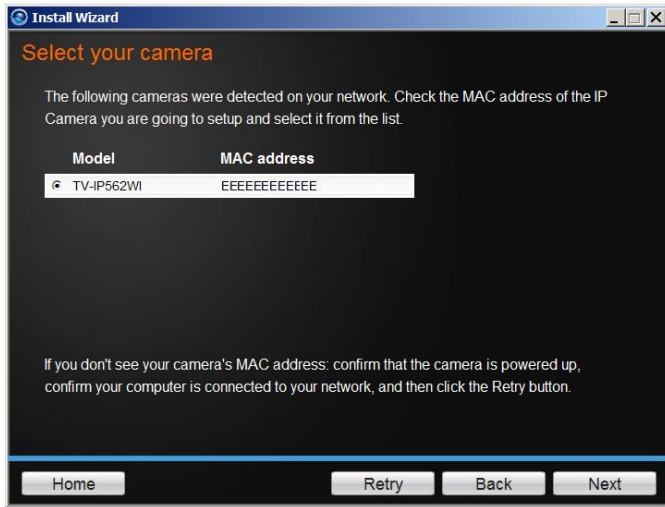

- 6. **Change Password.** The default username and password is **admin**. Tick the **Change Password** checkbox to enter the new password details. The password should be between 8 and 30 characters. Click **Next** to continue.

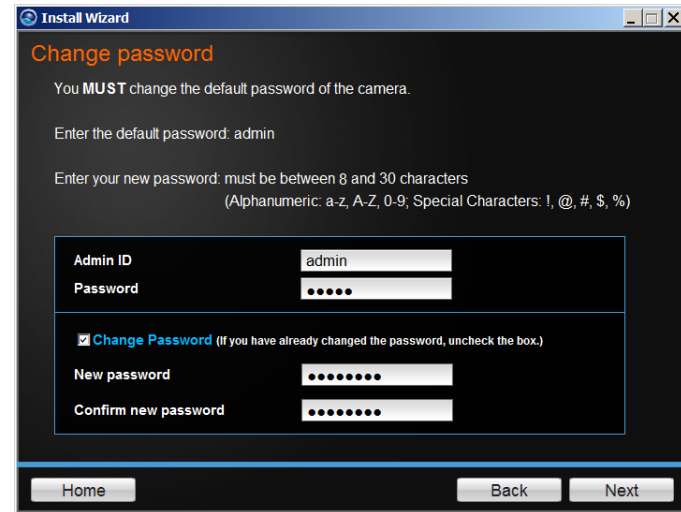

**Note:**

If you enter the incorrect admin details, you will be prompted to change the configuration, as shown below.

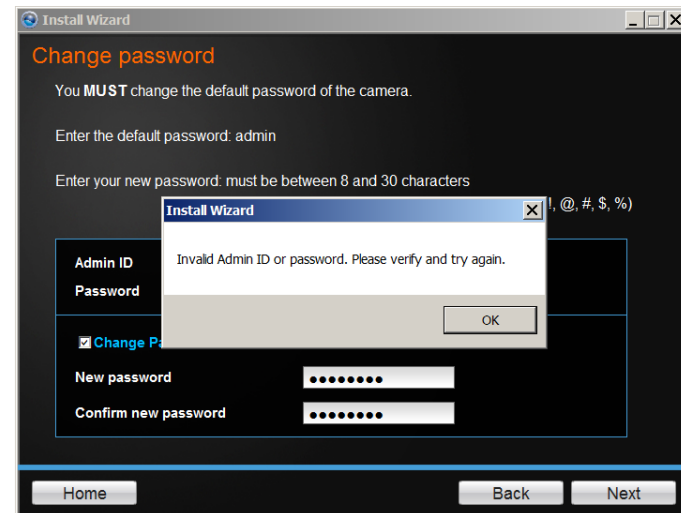

If the password length is less than 8 characters, you will also be prompted to alter the configuration, as shown below.

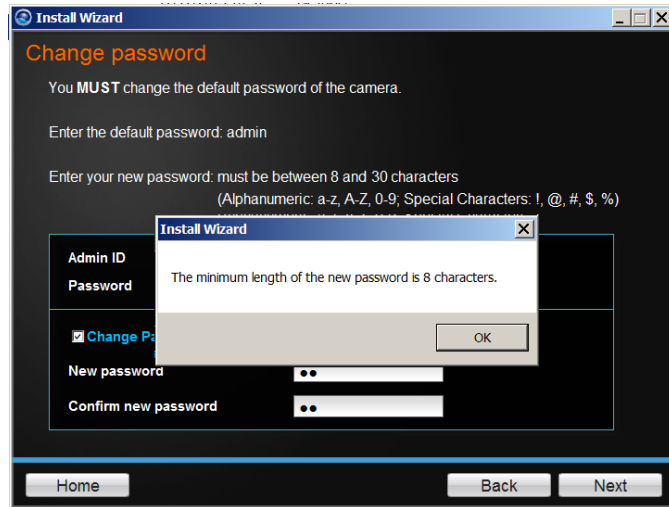

7. The wizard will now configure your parameters.

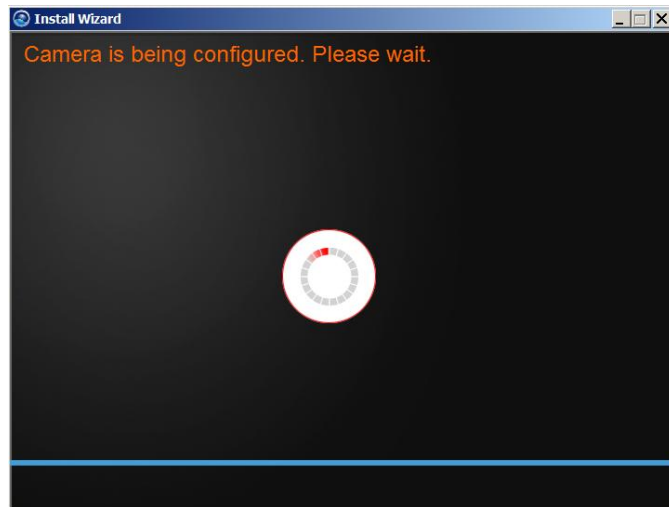

8. Once your wireless network has been discovered, the wizard will provide you with an option to select the **Available Wireless Network** and also to provide a **Wireless Network Password**. If you do not see your wireless network details, click the **Rescan** link to scan the network again.

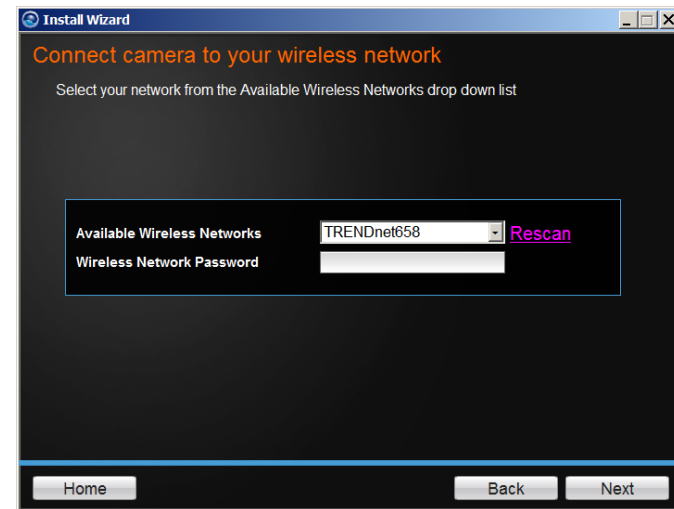

9. The wizard will search for wireless Access Points. Click the Rescan button if you do not find your AP.

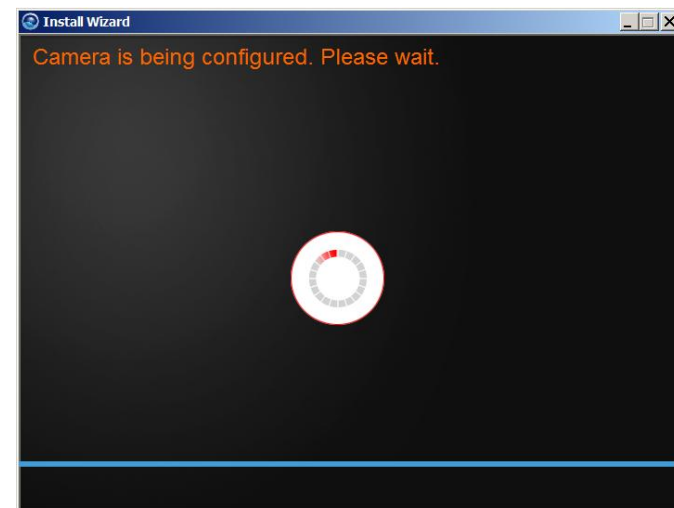



10. Disconnect your network cable from the camera/router. Click **Next** to continue.

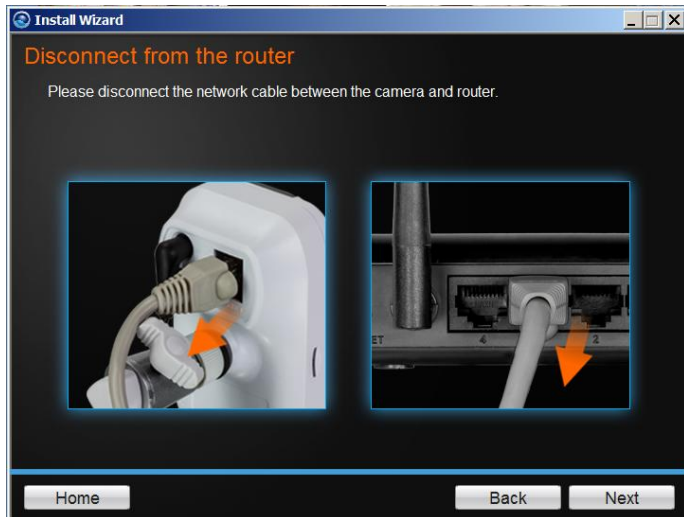

11. The camera will connect to the wireless network.

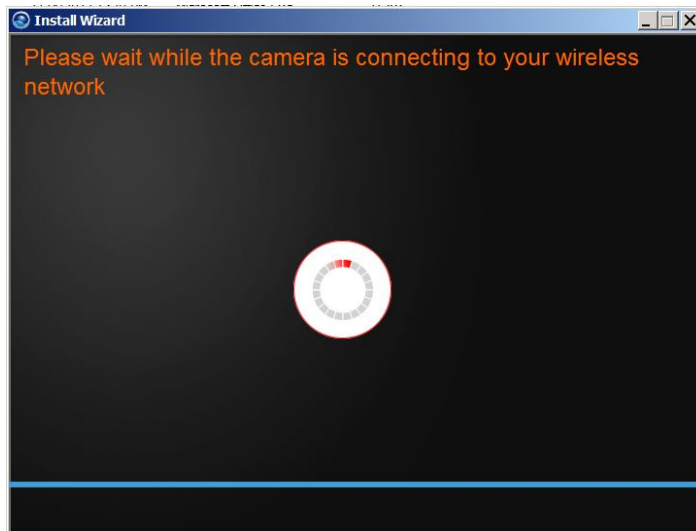

12. The initial setup is complete. Click the link to navigate to the camera's Web User Interface for further configuration or click product image to create a shortcut. Click **Next** to continue.

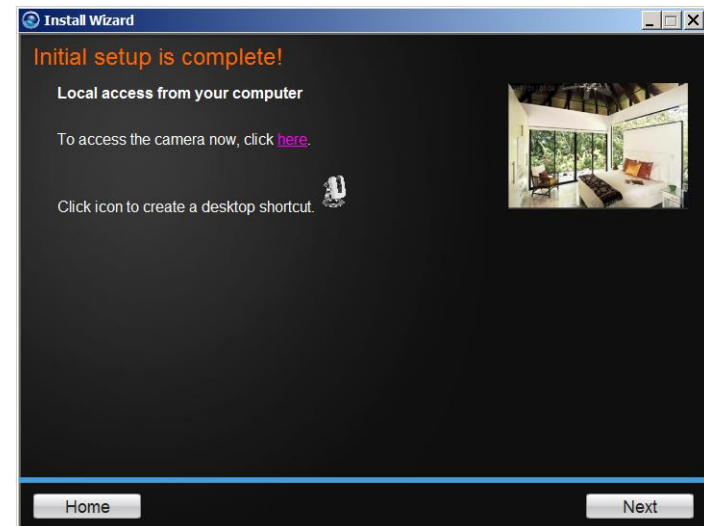

13. Scan the barcode to download the **TRENDnetVIEW App** for Apple iOS or Android™<sup>5</sup> devices. The app can also be found by searching TRENDnet from the Apple App Store or Google Play™<sup>6</sup>.

Please refer to the **Mobile Apps** section for additional app features information.

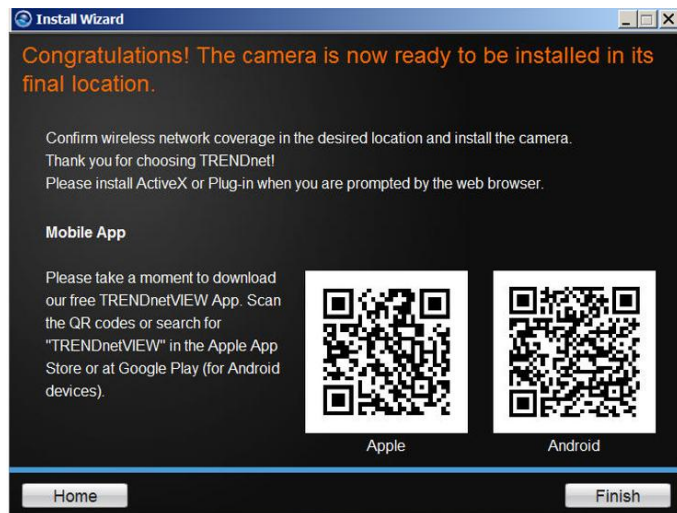

You are now ready to use your camera. Click **Finish** to exit.

## Mobile Apps

### Android Version

Using your mobile<sup>7</sup> device, an **Android** phone in this example, open the **Bar Code** scanning app on your phone. Hold it up to the **QR Code** on the wizard that reads, **Android**, and scan the image. The **Bar Code** app will read the QR Code and record it.

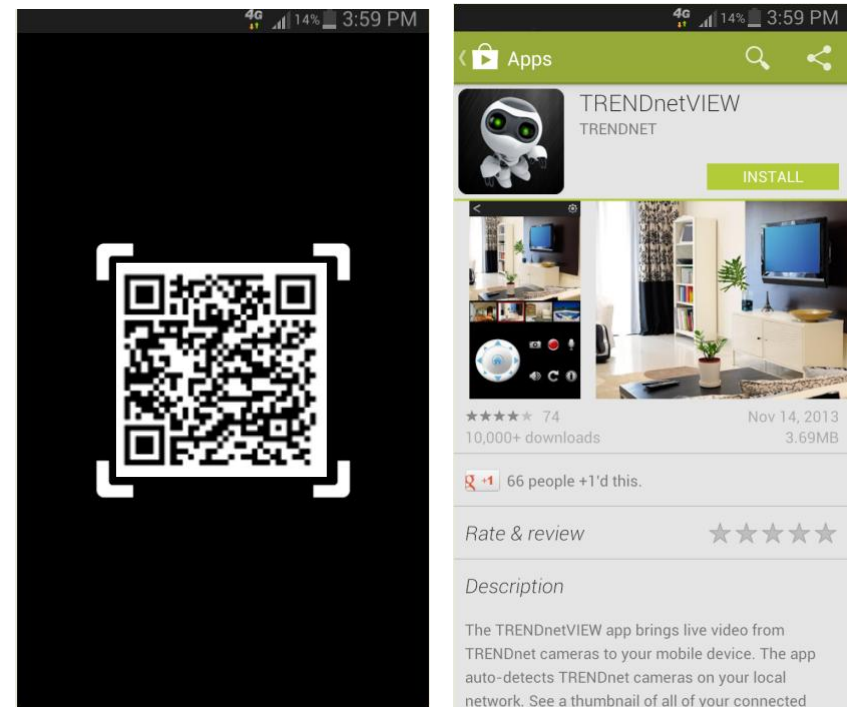

The app will copy the QR link and provides a HTML link to the TRENDnetVIEW app. You will be directed to the **Google Play™ Storefront** to download the app. Download the app, install it and use the app on your mobile device to view the TRENDnet camera.

<sup>5</sup> Android is a trademark of Google Inc.

<sup>6</sup> Google Play is a trademark of Google Inc.

<sup>7</sup> Please use the **Quick Installation Guide** to install the mobile applications or learn how to use mobile accessibility.

## Apple iOS version

Scan the QR Code using one of IOS's QR Code apps. The app will automatically create an HTML link to the iTunes App Store. You will be immediately directed to the iTunes App Store. Click the link to download.

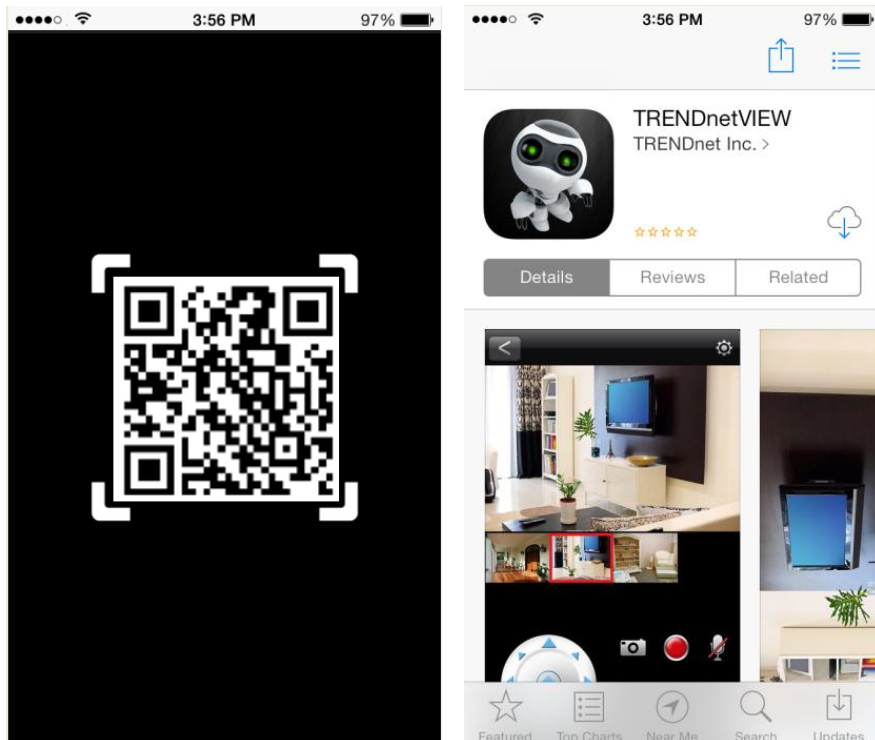

## Setup Wizard (Finding IP address of the cameras)

To locate the IP address of your camera(s) on the same network with your PC, please install the Setup Wizard utility (for Windows only) from the SetupWizard folder .

1. Insert the included CD-ROM into your CD/DVD drive, browse to the CD drive of the **SetupWizard** folder and run **SetupWizardSetup\_1.2.3.4804.msi** to begin the installation wizard.
2. The following screen will show up. Click **Next** and following the screen to finish the installation.

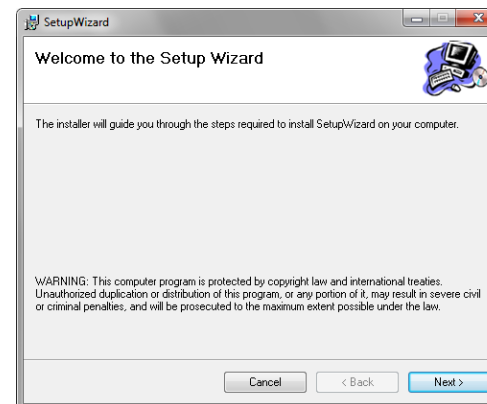

3. Click **Close** to finish the installation.

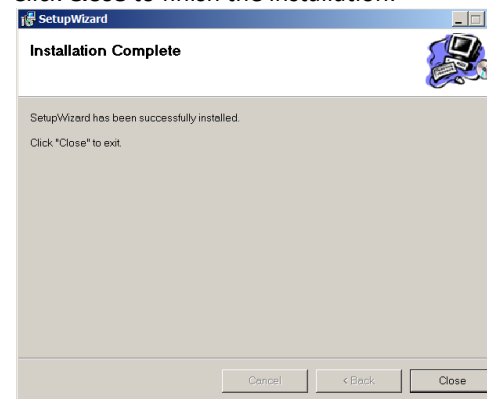

- Click **Start > Programs > TRENDnet > SetupWizard > SetupWizard**. The TRENDnet Setup Wizard appears.
- Connect an RJ-45 cable from a switch/router to the Ethernet port on the back of the camera and connect the AC power adapter to the camera. Click **Next** to proceed.



- From the list of cameras that appears, select the camera and click **Next** to continue. If your camera is not listed, please ensure your camera is powered on and connected to the network then click **Re-Scan** to scan the camera from your network.



- Login to your camera by entering the ID and Password. By default, both the ID and Password are set to **admin**. Click **Next** to continue.



- It is strongly recommended that you change your password to secure the camera from being accessed by others. Check the **Change Password** box and enter the new password in both password fields to confirm the new password. Click **Next** to continue.



9. Enter a camera name, date and time. The name will be used to identify your camera on the network. If your camera is in the same time zone as the computer you are using, click the **Copy Local Time** icon to copy the local time to the camera. Click **Next** to continue.

**TRENDNET Setup Wizard**

**Other Settings**  
You can configure a name for the camera. You can also adjust the clock for the camera by inputting the current time in the "Camera Time" field. Click "Copy Local Time" to synchronize the camera time with your PC. Click "Next" to continue setting up your camera.

Camera Name  
TV-IP62WI

Camera Time  
2013/01/01

00:14:29

Copy Local Time Previous Next Exit

Copyright © 2012 TRENDnet, Inc. All rights reserved.

10. Select a connection option and click **Next** to continue.

**PPPoE:** Select this option if your camera is directly connected to a DSL modem and your ISP requires a PPPoE authentication to the Internet.

**DHCP:** Select this option if your camera is connected to a router and DHCP is enabled.

**Fixed IP:** Select this option if you wish to connect the camera via a fixed IP.

**TRENDNET Setup Wizard**

**Select a Connection Option**  
Please select the connection option based on your network environment. If you do not know which option to choose, use the default option.

PPPoE (Select this option if you will connect the IP camera directly to a DSL Modem and your ISP requires PPPoE authentication to access the Internet.)

DHCP (Select this option if your camera is connected to a router and DHCP is enabled.)

Fixed IP (Select this option if you want to configure the camera with static IP address.)

Previous Next Exit

Copyright © 2012 TRENDnet, Inc. All rights reserved.

11. If you would like to setup the wireless connection, click **I want to use wireless for the camera** or click **No, I don't want to use wireless for the camera**.

**TRENDNET Setup Wizard**

**Setup Wireless**  
In this section, you can choose whether to enable wireless on the camera. Click "Next" to continue setting up your camera.

I want to use wireless for the camera.

No, I don't want to use wireless for the camera.

Previous Next Exit

Copyright © 2012 TRENDnet, Inc. All rights reserved.

12. Select the available AP from drop down menu. Select the SSID, wireless mode, authentication, encryption and type in the wireless key.

**TRENDNET Setup Wizard**

**Manually Setup Wireless Settings**  
In this section, you can set up the camera's wireless settings. Click "Next" to continue setting up your camera.

Available AP: TRENDnet731

SSID: TRENDnet731

Wireless Mode: Infrastructure

Channel: Auto

Authentication: WPA2-PSK

Encryption: TKIP

Key: \*\*\*\*\*

Re-Scan Previous Next Exit

Copyright © 2012 TRENDnet, Inc. All rights reserved.

13. A summary screen of the settings you have chosen appears. Click Next to continue.



14. After the Setup Wizard configures the camera, the wizard starts to setup process.

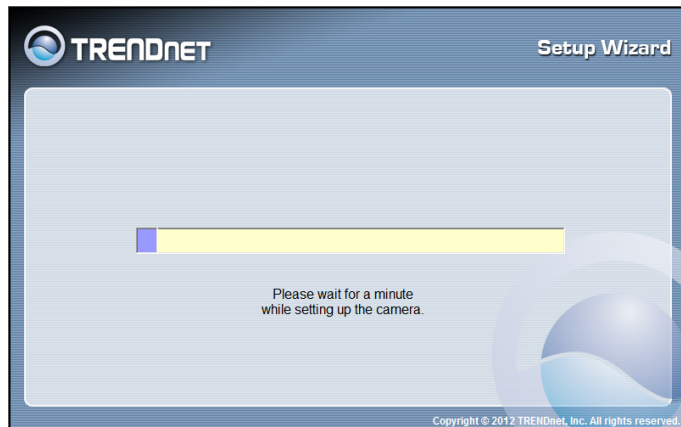

15. Select **Wired Mode** or **Wireless Mode** to connect your camera now.

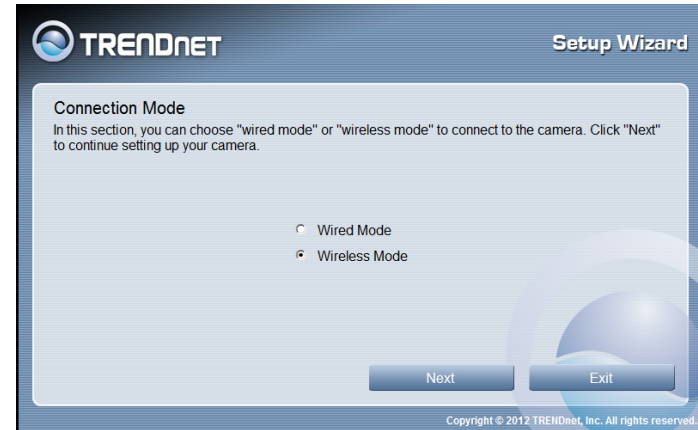

16. Disconnect Network cable if you continuing with wireless connection.

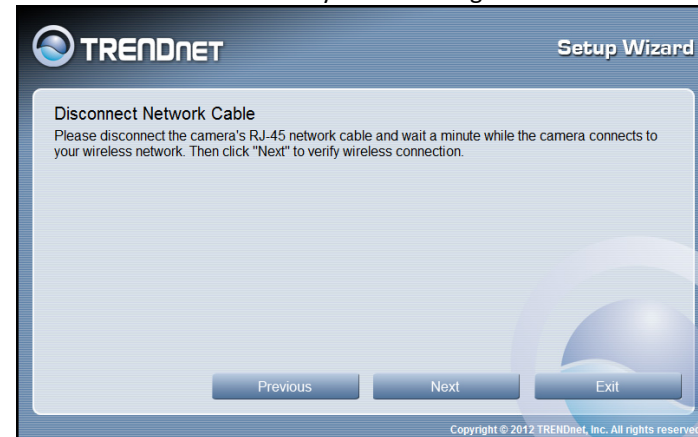

- 17. Wait a few minutes allow wireless connection be setting up.

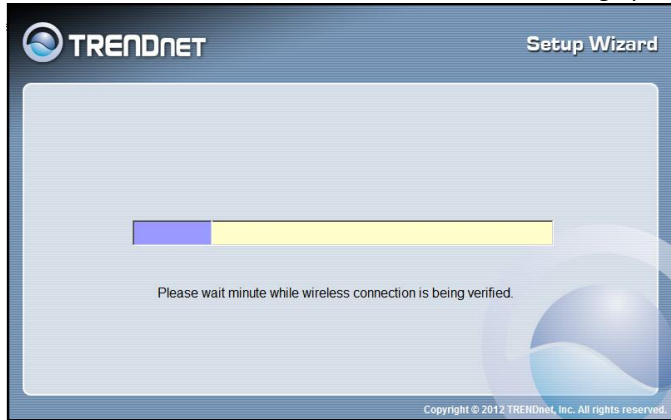

- 18. When the Setup Wizard has finished, the configuration is complete and the following screen appears:

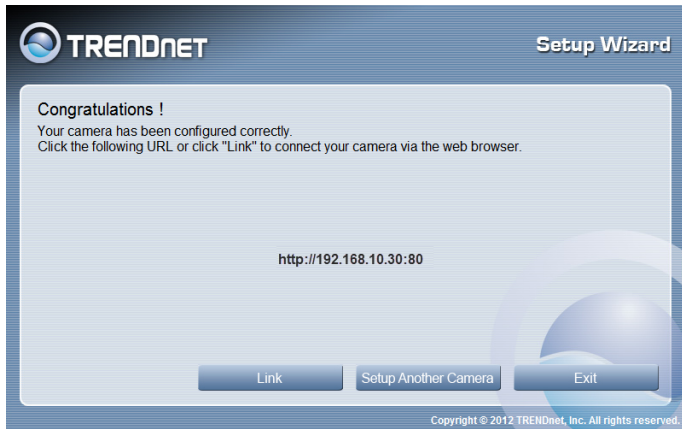

## Web Browser Management

After completing the AutoRun Wizard from the CD, you are ready to use your camera. The camera's built-in Web configuration utility is designed to allow you to easily access and configure your TV-IP562WI camera. Open a web browser such as Internet Explorer® and enter the IP address of your camera (through the setup wizard utility software on the CD). To log in, type the Username **admin** and the password you created in the Autorun Wizard. If you did not create a password or you just press the reset button for reset, the default password is **admin**. After entering your password, click **OK**.

**Note:** By default, this camera obtains an IP address from a DHCP server on the local network. To find the IP address of the camera, consult the DHCP client list on the DHCP server on your wireless router or install the Setup Wizard utility software from CD. However, if there is no DHCP server available, the static default IP address of this camera is 192.168.10.30, in case you are connecting the camera directly with your PC without another device in-between.

These initial steps are using **Internet Explorer**.

To log in, type the Username **admin** and the password you created in the Setup Wizard. If you did not create a password, the default password is **admin**. After entering your password, click **OK**.



After you have logged in, Internet Explorer will prompt you to install the camera add-on required. Click **Allow** to install the add-on.

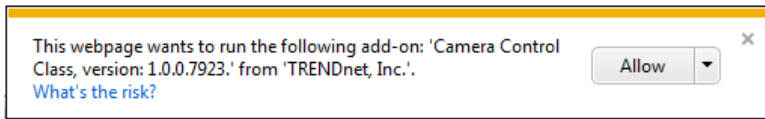

After the add-on was successfully installed, the **Live View** video feed will be displayed.

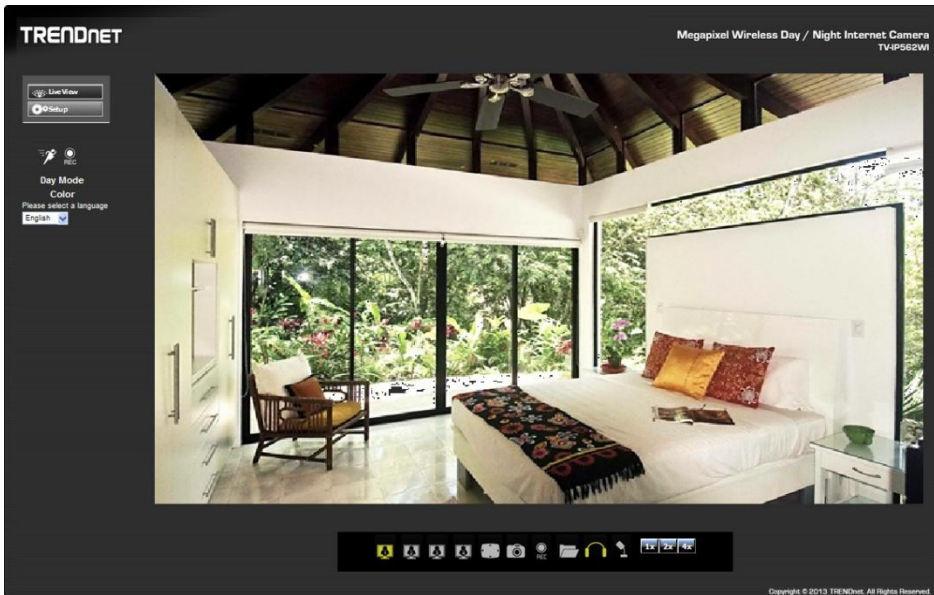

These initial steps are for using a **non-Internet Explorer** web browser.

After you have logged in, you will need to install the required plug-in. Click the link below the camera viewing window to install the plug-in.

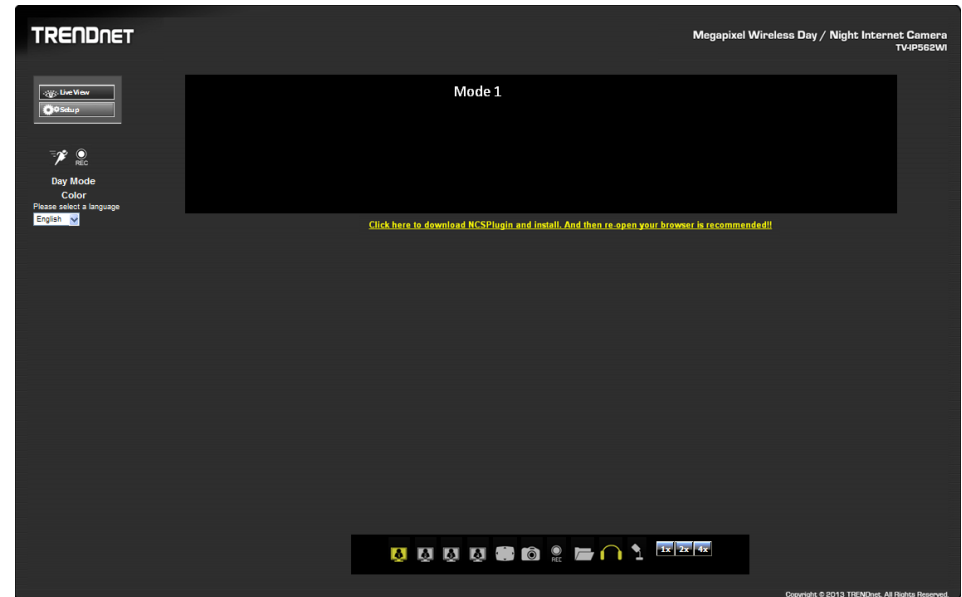



Download the plugin to a folder on the local PC and run the downloaded plugin installation file after the download. Click **Next** to continue.

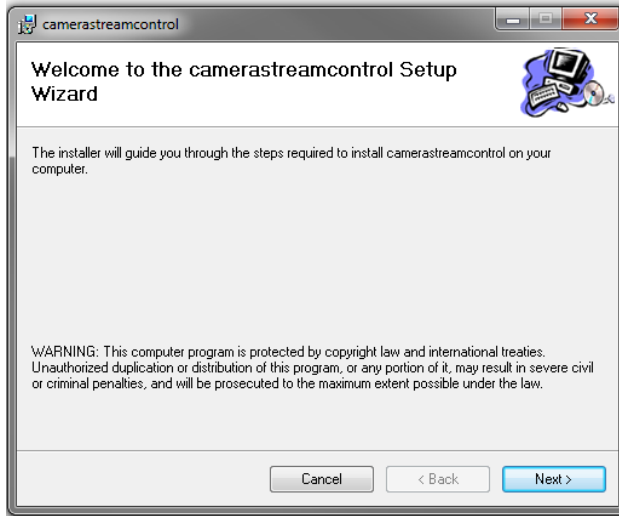

The Camera stream control application will be installed. **Note:** Make sure all Internet browsers are closed during this installation. Click **Close** to finish the installation.

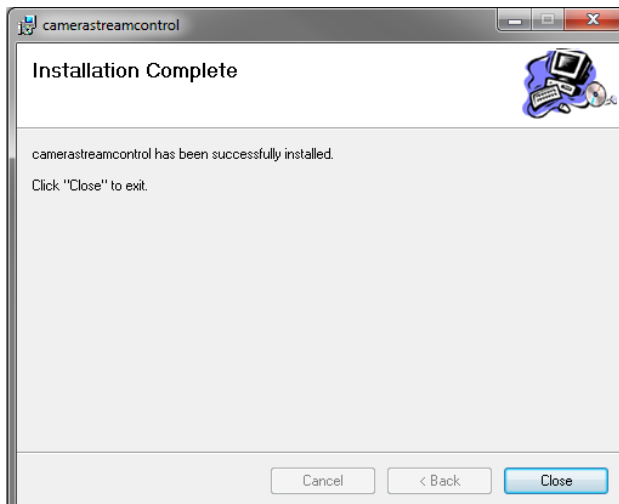





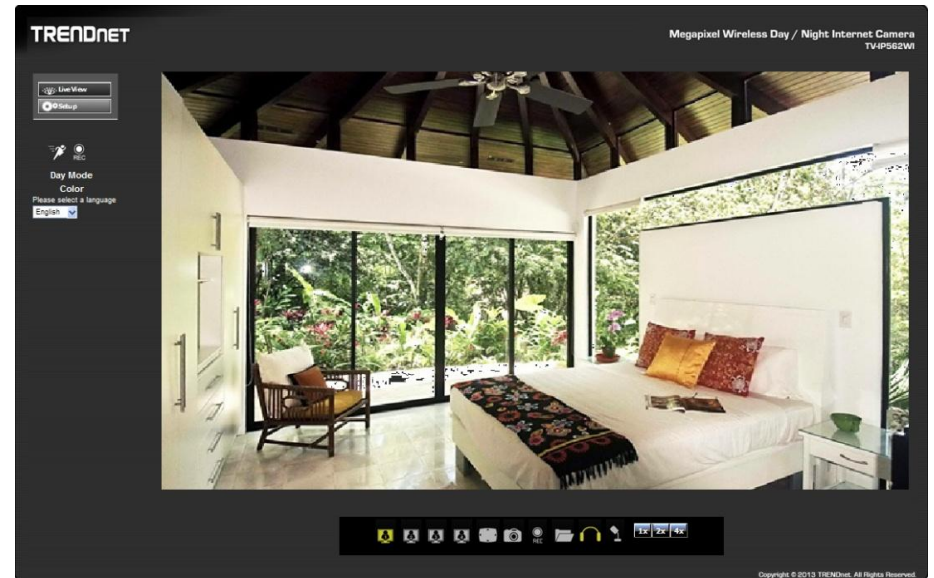







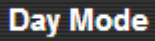
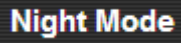

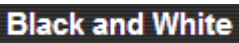
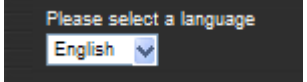
## Main Web User Interface

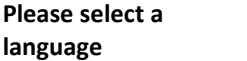



After successfully logging into the Web User Interface of the camera, the following window will appear.



The following table describes all the icons and settings that can be configured on the Live View page:

Icon	Description
	Click this button to view the live video feedback of this camera.
	Click this button to access the setup pages for this camera.
	This icon is used to display the motion detection status of the current live video feed. This icon will be white when no motion is detected and will be yellow when motion is detected.
	This icon is used to display the recording status of the current live video feed. This icon will be white when not recording and will be yellow when recording.
	Day Mode will be displayed when the camera is supplying video feed in a daylight (normal light) environment.
	Night Mode will be displayed when the camera is supplying video feed in a night time (low light) environment.
	When the Day Mode is active, the video feed will be in color.
	When the Night Mode is active, the video feed will be in black and white.
	From the drop-down menu, select a language.

Icon	Description
	Select the display language here. Options to choose from are English, German, Spanish, Russian, and French.
	Click this icon to view the video profile 1.
	Click this icon to view the video profile 2.
	Click this icon to view the video profile 3.
	Click this icon to view the video profile 4.
	Click this icon to view the video feed in the full screen mode.
	Click this icon to manually take a snapshot of the video feed.
	Click this icon to manually enable or disable video recording.

Icon	Description
	Click this icon to specify the video/snapshot storage folder on the local PC.
	Click this icon to enable or disable the audio feed from the camera.
	Click this icon to enable or disable the audio feed to the camera.
	Click this icon to manually toggle the video feed between the Day and the Night Modes.
	Click one of these options to digitally zoom the video feed by 1, 2 or 4 times.

## Setup

In the **Setup** section we can view and configure more advanced features available on the IP camera. After clicking the Setup button, the following page will be displayed.

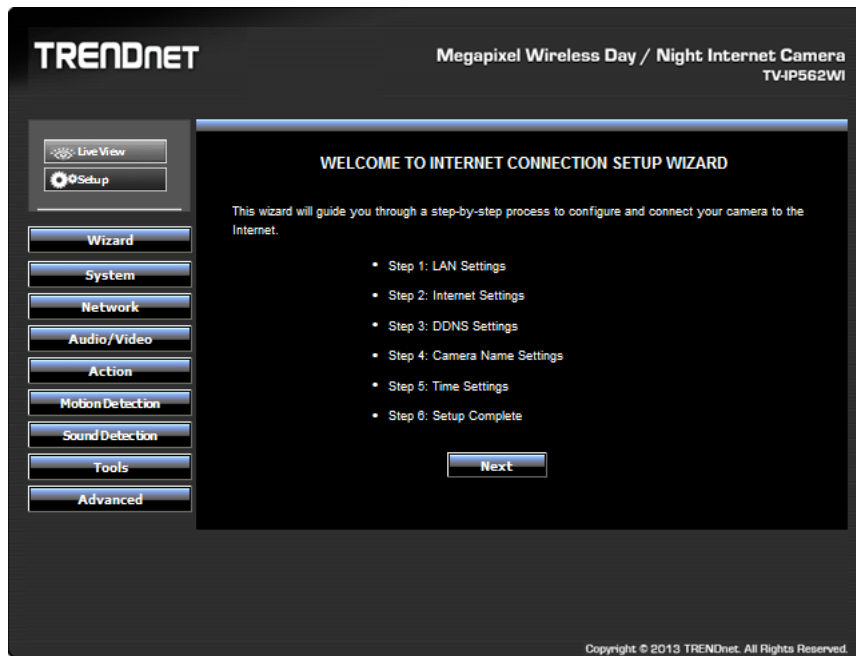

In the left side of this page, there is a **Category** menu. Except for **Wizard**, **Motion Detection**, and **Sound Detection**, within each category, there are multiple pages available that are used to configure different types of features available on this camera.

## Wizard

The first category option available is **Wizard**. The setup wizard will guide users through a simplified step-by-step wizard to configure basic settings available on this camera.

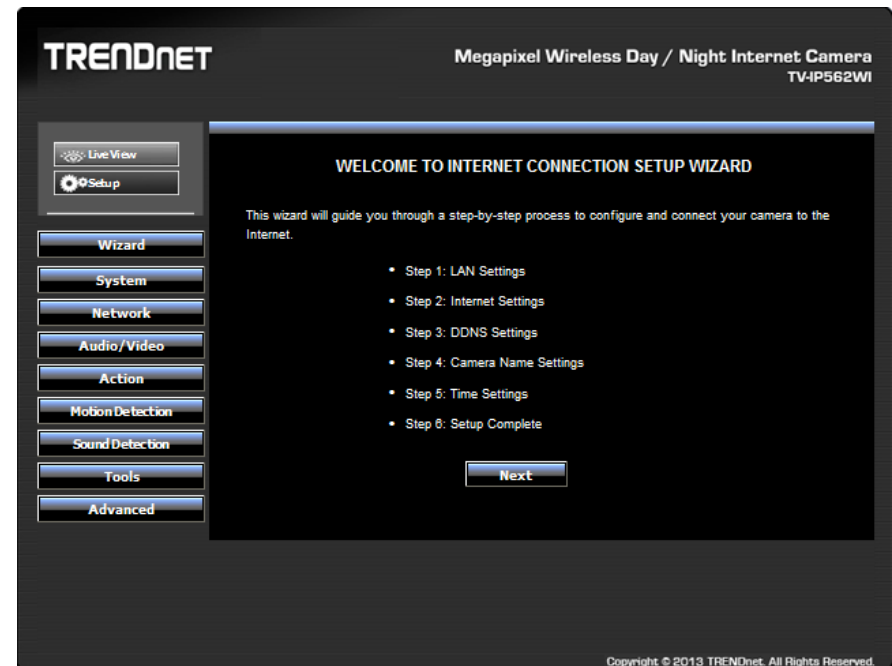

This first page of the wizard will display a welcome message and layout the steps that will be followed using this wizard. Click **Next** to continue.

### Step 1: LAN Settings

On this page, users can configure the IPv4 and IPv6 connection settings for this camera. Select **DHCP Connection** to allow the camera to automatically obtain the IPv4 or IPv6 settings from a DHCP server on the local network, or select **Static IP Address** to manually enter the IPv4 and IPv6 connection settings. Click **Next** to continue.

**STEP 1: LAN SETTINGS**

Please select the IP addressing type that your camera will be connected by DHCP or Static IP Address. If your camera is connected to a router, or you are unsure which settings to pick, we recommend that you could keep the default selection as DHCP connection. Otherwise, select Static IP Address to assign an IP address manually before clicking on the Next button.

**IPv4 Settings**

- DHCP Connection
- Static IP Address

IPv4 Address	192.168.10.30
Subnet Mask	255.255.255.0
Default Gateway (Router)	192.168.10.1
Primary DNS	
Optional Secondary DNS	
Optional Search Domain	

**IPv6 Settings**

- DHCP Connection
- Static IP Address

IPv6 Address / Prefix Length		/ 64
Default Gateway(Router)		
Primary DNS		
Optional Secondary DNS		

Back Next Cancel

### Step 2: Internet Settings

Click the checkbox to enable the Internet connection via PPPoE. On this page users can enter the PPPoE Username and Password. Click the checkbox to enable this feature. This information can be acquired from your ISP. Click Next to continue.

**STEP 2: INTERNET SETTINGS**

If your ISP is using PPPoE, please enable this setting and enter your ISP Username and Password. Then, click on the Next button. Please contact your ISP if you do not know your Username and Password.

Enabled

Username

Password

Back Next Cancel

### Step 3: DDNS Settings

Click the checkbox to enable DDNS. In **Server Address**, select one of the domains from the drop-down menu. The field to the left of the drop-down menu automatically populates. Under **Host Name** enter the name the DDNS service provided. Enter a **Username** and **Password**, repeat the password and finally enter the **Timeout** value. Timeout states the time DDNS is updated. Click **Next** to continue.

**STEP 3: DDNS SETTINGS**

If you have a Dynamic DNS account and would like the camera to update the IP address automatically, please enable DDNS and enter your host information below. Then, click on the Next button to continue.

Enable

Server Address NO-IP.com << Select DDNS Server

Host Name

User Name

Password

Confirm Password

Timeout 576 Hour

Back Next Cancel

## Step 4: Camera Name Settings

Enter a name for the camera. This feature is helpful when you have more than one camera setup. Click Next to continue.

**STEP 4: CAMERA NAME SETTINGS**

We recommend that you rename your camera for easy accessibility. You can then identify and connect to your camera via this name. Please assign a name of your choice before clicking on the Next button.

Camera Name

## Step 5: Time Settings

From the drop-down menu, select a Time Zone. To enable daylight saving time, click the checkbox next to Enable Daylight Saving. Or Select the Keep Current Date and Time or Synchronize with Network Time Protocol server.

**STEP 5: TIME SETTINGS**

Please configure the correct time to ensure that all events are triggered, captured and scheduled at the right time. Then, click on the Next button.

Time Zone

Enable Daylight Saving

Keep Current Date and Time

Synchronize with Network Time Protocol server

Setup Date and Time Manually

After enabling the daylight savings feature, the following will appear. Select **Auto Daylight Saving** allowing the camera to automatically detect the daylight saving time.

**STEP 5: TIME SETTINGS**

Please configure the correct time to ensure that all events are triggered, captured and scheduled at the right time. Then, click on the Next button.

Time Zone

Enable Daylight Saving

Auto Daylight Saving

Set DST Manually

Keep Current Date and Time

Synchronize with Network Time Protocol server

Setup Date and Time Manually

To manually setup Daylight saving, select **Set DST manually** option.

Select the **Offset** of the time within 1 to 2 hours. Then select a **Start Time** and an **End Time** from the drop-down menus provided.

**STEP 5: TIME SETTINGS**

Please configure the correct time to ensure that all events are triggered, captured and scheduled at the right time. Then, click on the Next button.

Time Zone

Enable Daylight Saving

Auto Daylight Saving

Set DST Manually

Offset

	Month	Week	Day of Week	Hour	Minute
Start Time	3	2	Sunday	2	0
End Time	11	1	Sunday	2	0

Keep Current Date and Time

Synchronize with Network Time Protocol server

Setup Date and Time Manually

After selecting the **Synchronize with Network Time Protocol server** option, the following will appear.

Select and enter the **NTP Server** address used here or alternatively select the **Set NTP Server from DHCP** option to allow the camera to obtain the date and time settings from the NTP Server that is configured to run in collaboration with the DHCP server on your local network.

Select the **Setup Date and Time Manually** option to manual configure the date and time settings for this camera.

**STEP 5: TIME SETTINGS**

Please configure the correct time to ensure that all events are triggered, captured and scheduled at the right time. Then, click on the Next button.

Time Zone: (GMT-08:00) Pacific Time (US&Canada)

Enable Daylight Saving

Keep Current Date and Time

Synchronize with Network Time Protocol server

NTP Server

Set NTP Server from DHCP

Setup Date and Time Manually

Back Next Cancel

## Step 6: Setup Complete

This is the final screen of the wizard. It shows the configuration options selected. Click **Apply** to make the changes. After clicking the **Apply** button, a notice will appear to mention that the camera will restart in 60 seconds and that it is saving the settings to the camera. After the restart, the Web UI will direct back to the start of the wizard.

**STEP 6: SETUP COMPLETE**

Below is a summary of your camera settings. Click on the Back button to review or modify settings or click on the Apply button if all settings are correct. It is recommended to note down these settings in order to access your camera on the network or via your web browser.

IPv4 Address	DHCP
IPv6 Address / Prefix Length	DHCP
IP Camera Name	TV-IP562WI
Time Zone	(GMT-08:00) Pacific Time (US&Canada)
DDNS	Disabled
PPPoE	Disabled

Back Apply Cancel

## System

The next category option available is **System**. In the **System** category we can configure administrative settings and the date and time settings.

**TRENDNET** Megapixel Wireless Day / Night Internet Camera TV-IP562WI

**ADMIN SETTING**

Admin User Name  30 characters maximum

Old Password  30 characters maximum

New Password  30 characters maximum

Confirm New Password  Password Rule: Alphanumeric (A-Z, a-z, 0-9), and Special Characters (!, @, #, \$, %)

**Save**

**ADD USER ACCOUNT**

User Name  30 characters maximum

New Password  30 characters maximum

Confirm New Password  Password Rule: Alphanumeric (A-Z, a-z, 0-9), and Special Characters (!, @, #, \$, %)

**Add** 20 users maximum

**USER LIST**

User Name  **Delete**

**AUTHENTICATION**

RTSP Authentication

HTTP Authentication

Snapshot URL Authentication  
(<http://192.168.1.89/image/jpeg.cgi>)

**Save**

**DEVICE SETTING**

Camera Name  30 characters maximum

On-Screen Display(OSD)

Label  30 characters maximum

Time Stamp

LED light

**Save**

Copyright © 2013 TRENDnet. All Rights Reserved.

## Admin

In the **Admin Settings** section, we can configure the following.

**ADMIN SETTING**

Admin User Name  30 characters maximum

Old Password  30 characters maximum

New Password  30 characters maximum

Confirm New Password  Password Rule: Alphanumeric (A-Z, a-z, 0-9), and Special Characters (!, @, #, \$, %)

**Save**

In this section we can configure the **administrator** account's login credentials that will be used to login to the camera's Web UI. In the **Admin User Name** field, enter the login username that will be used for this camera. In the **Old Password** field enter the old/current login password of the camera. In the **New Password** and **Confirm New Password** fields, enter the new login password that will be used for this camera. Click the **Save** button to save the modifications made.

Note that the password can only contain: **Alphanumeric: A-Z, a-z, 0-9, and Special Characters: !, @, #, \$, %** and must be between 8 to 30 characters.

In the **Add User Account** section, we can configure the following.

**ADD USER ACCOUNT**

User Name  30 characters maximum

New Password  30 characters maximum

Confirm New Password  Password Rule: Alphanumeric (A-Z, a-z, 0-9), and Special Characters (!, @, #, \$, %)

**Add** 20 users maximum

In this section we can configure the **user** account's login credentials that will be used to login to the camera's Web UI. In the **User Name** field, enter the login username that will be used for this camera. In the **New Password** and **Confirm New Password** fields, enter the new login password that will be used for this camera. Click the **Add** button to add the new user account created.

In the **User List** section, we can configure the following.

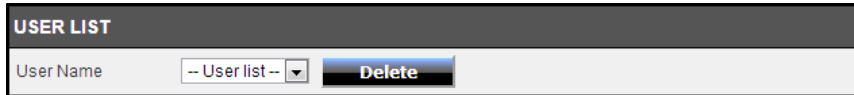

USER LIST

User Name
-- User list --

Delete

The **User Name** list will be populated with the names of the user accounts created in the previous section. To delete a user, select the user from the drop-down list and click the **Delete** button.

In the **Authentication** section, we can configure the following.

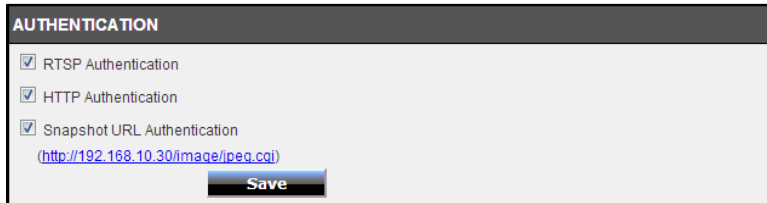

AUTHENTICATION

- RTSP Authentication
- HTTP Authentication
- Snapshot URL Authentication  
<http://192.168.10.30/image/jpeg.cgi>

Save

Tick the **RSTP Authentication** option to enable RSTP real-time authentication. Tick the **HTTP Authentication** option to enable HTTP authentication. Tick the **Snapshot URL Authentication** option to enable snapshot authentication of the current video stream using the hyperlink. Click the **Save** button to save the modifications made.

In the **Device Settings** section, we can configure the following.

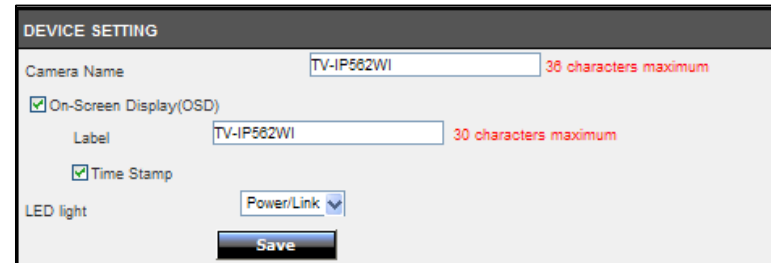

DEVICE SETTING

Camera Name  36 characters maximum

On-Screen Display(OSD)

Label  30 characters maximum

Time Stamp

LED light

Save

Enter the **Camera Name** in the space provided. Tick the **On-Screen Display (OSD)** option to display the label, date and time on the video feed. Enter the **Label** name in the space provided. Tick the **Time Stamp** option to display the date and time on the video feed. Select the **LED light** option from the drop-down list. When selecting the **Power/Link** option, the LED will light up when the camera has power and a network link. When selecting the **Off** option, the LED will be turned off. When selecting the **Blinking** option, the LED will rhythmically blink.



## Time and Date

In the **Time Configuration** section, we can configure the following.

The screenshot shows the 'TIME CONFIGURATION' section. At the top, there is a 'Time Zone' dropdown menu set to '(GMT-08:00) Pacific Time (US&Canada)'. Below this, there is a checked checkbox for 'Enable Daylight Saving'. Underneath, there are two radio button options: 'Auto Daylight Saving' (unselected) and 'Set DST Manually' (selected). Below these is an 'Offset' dropdown menu set to '+1:00'. At the bottom, there are two rows of time settings: 'Start time' and 'End time'. Each row has dropdown menus for 'Month', 'Week', 'Day of week', 'Hour', and 'Minute'. The 'Start time' row is set to Month: 3, Week: 2, Day of week: Sunday, Hour: 2, Minute: 0. The 'End time' row is set to Month: 11, Week: 1, Day of week: Sunday, Hour: 2, Minute: 0.

Select the **Time Zone** option from the drop-down menu. Tick the **Enable Daylight Saving** option to enable the daylight saving feature on this camera. Select the **Auto Daylight Saving** option to automatically receive the daylight saving update from the time server. Select the **Set DST Manually** option to manually configure the daylight saving time options. After selecting to manually configure the daylight saving time, select the **Offset** value used. Select the **Start time** and **End time** options.

In the **Automatic Time Configuration** section, we can configure the following.

The screenshot shows the 'AUTOMATIC TIME CONFIGURATION' section. It features a checked checkbox for 'Synchronize with Network Time Protocol server'. Below this, there are two radio button options: 'NTP Server' (selected) and 'Set NTP Server from DHCP' (unselected). The 'NTP Server' option has an empty text input field next to it.

Tick the **Synchronize with Network Time Protocol server** option to enable the automatic time configuration option. Enter the **NTP Server** address of the time server used here or select the **Set NTP Server from DHCP** option to allow the camera to obtain the date and time settings from the NTP Server that is configured to run in collaboration with the DHCP server on your local network.

In the **Set Date and Time Manually** section, we can configure the following.

The screenshot shows the 'SET DATE AND TIME MANUALLY' section. It features a checked checkbox for 'Setup Date and Time Manually'. Below this, there are dropdown menus for 'Year' (2013), 'Month' (1), 'Day' (1), 'Hour' (6), 'Minute' (5), and 'Second' (41). At the bottom of the form, there is a button labeled 'Sync with Computer Time'. Below the form, there are two buttons: 'Apply' and 'Cancel'.

Tick the **Setup Date and Time Manually** option to manually configure the date and time settings for this camera. Select the **Year**, **Month**, **Day**, **Hour**, **Minute**, and **Second** options from the drop-down menus provided to manually configure the date and time settings used by the camera. Alternatively, click the **Sync with Computer Time** button to automatically configure the camera's date and time settings to be the same as the current date and time settings on the local computer. Click the **Apply** button to apply the modifications made.

## Network

The next category option available is **Network**. In the **Network** category we can configure the wired and wireless network settings. Also available for configuration in this category is Dynamic DNS.

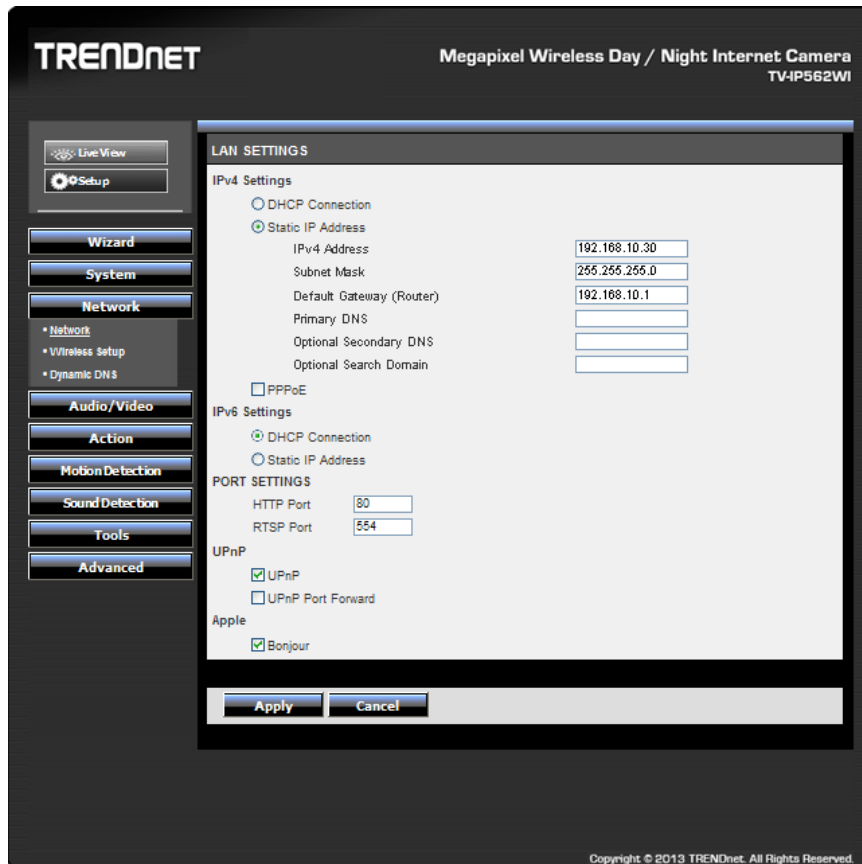

## Network

In the **LAN Settings** section, we can configure the following.

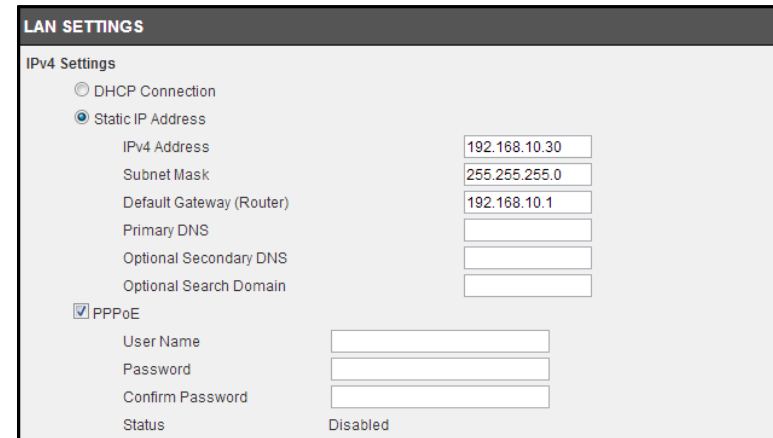

In the **IPv4 Settings** part, we can configure the IPv4 network settings used by this camera. Select the **DHCP Connection** option to automatically obtain the IPv4 network settings, for this camera, from a DHCP server, located on the local network.

Select the **Static IP Address** option to manually configure the IPv4 network settings used by this camera. Enter the **IPv4 Address**, **Subnet Mask**, **Default Gateway**, **Primary DNS**, **Optional Secondary DNS**, and **Optional Search Domain** parameters in the spaces provided.

This camera can connect to the Internet directly through the means of a PPPoE connection. Tick the **PPPoE** option to enable this feature. Enter the PPPoE Internet connection's **User Name** and **Password** in the spaces provided. This information can be acquired from your ISP.

**IPv6 Settings**

DHCP Connection

Static IP Address

IPv6 Address / Prefix Length  / 64

Default Gateway(Router)

Primary DNS

Optional Secondary DNS

In the **IPv6 Settings** part, we can configure the IPv6 network settings used by this camera. Select the **DHCP Connection** option to automatically obtain the IPv6 network settings, for this camera, from a DHCP server, located on the local network.

Select the **Static IP Address** option to manually configure the IPv6 network settings used by this camera. Enter the **IPv6 Address/Prefix Length**, **Default Gateway (Router)**, **Primary DNS**, and **Optional Secondary DNS** parameters in the spaces provided.

**PORT SETTINGS**

HTTP Port

RTSP Port

**UPnP**

UPnP

UPnP Port Forward

External HTTP

External RTSP

In the **Port Settings** part, enter the **HTTP Port** and **RSTP Port** numbers used.

In the **UPnP** part, tick the **UPnP** option to enable the UPnP feature on this camera. Tick the **UPnP Port Forward** option to enable the UPnP port forwarding feature. Enter the **External HTTP** and **External RSTP** port number in the respective spaces provided.

**Apple**

Bonjour

In the **Apple** part, we can enable the **Bonjour** feature. Click the **Apply** button to apply the modifications made.

## Wireless Setup

In the **Wireless Configuration** section, we can configure the following.

**WIRELESS CONFIGURATION**

Click the **Enable Wireless** button to enable the wireless feature for this camera. After clicking the **Enable Wireless** button, the camera will restart (80 seconds) and the following page will be available.

**WIRELESS CONFIGURATION**

Wireless

Network Name

Site Survey

Wireless Mode

Security Mode

Cipher Type

Key

Show Hidden Key

Un-tick the **Wireless** option to disable the wireless functionality of this camera. Enter the wireless **Network Name** (SSID) in the space provide or select the wireless network name from the **Site Survey** drop-down list. If the wireless network exists and is not displayed in the **Site Survey** drop-down list, click the **Rescan** button to rescan for available wireless networks.

Select the **Wireless Mode** for this camera. The two supported modes are **Infrastructure** and **Ad-Hoc**. When connecting the camera to a wireless access point or router, use the infrastructure mode. When connecting the camera to a wireless adapter directly, select the ad-hoc mode. After selecting the ad-hoc mode, we will be able to manually select the wireless **Channel** number used for the connection.

Select the **Security Mode** for this camera. The four supported security modes for this camera are **None**, **WEP**, **WPA-PSK**, and **WPA2-PSK**. After selecting WPA-PSK or WPA2-PSK as the security mode, select the **Cipher Type** used for this security mode. After selecting WEP, WPA-PSK, or WPA2-PSK as the security mode, enter the wireless **Key** used in the space provided.

Tick the **Show Hidden Key** option to display the key entered.

Click the **Apply** button to apply the modifications made.

## Dynamic DNS

Dynamic DNS is a method of keeping a domain name linked to a changing public IP address as not all public IP addresses are static. Typically, when a user connects to the Internet, the user's ISP assigns an unused IP address from a pool of IP addresses and this address is used only for the duration of that specific connection. This method of dynamically assigning addresses extends the usable pool of available IP addresses. A dynamic DNS service provider uses a special program that runs on the user's computer, contacting the DNS service each time the IP address provided by the ISP changes and subsequently updating the DNS database to reflect the change in IP address.

In the **Dynamic DNS Settings** section, we can configure the following.

Tick the **Enable** option to enable the Dynamic DNS feature. Select the DDNS service provider from the drop-down list after which the service provider's name will be moved to the **Server Address** field. Enter the **Host Name**, **User Name**, **Password**, and **Timeout** information in the spaces provided. Click the **Apply** button to apply the modifications made.

### Audio/Video

The next category option available is **Audio/Video**. In the **Audio/Video** category we can configure audio and video profiles and settings as well as configure image settings.

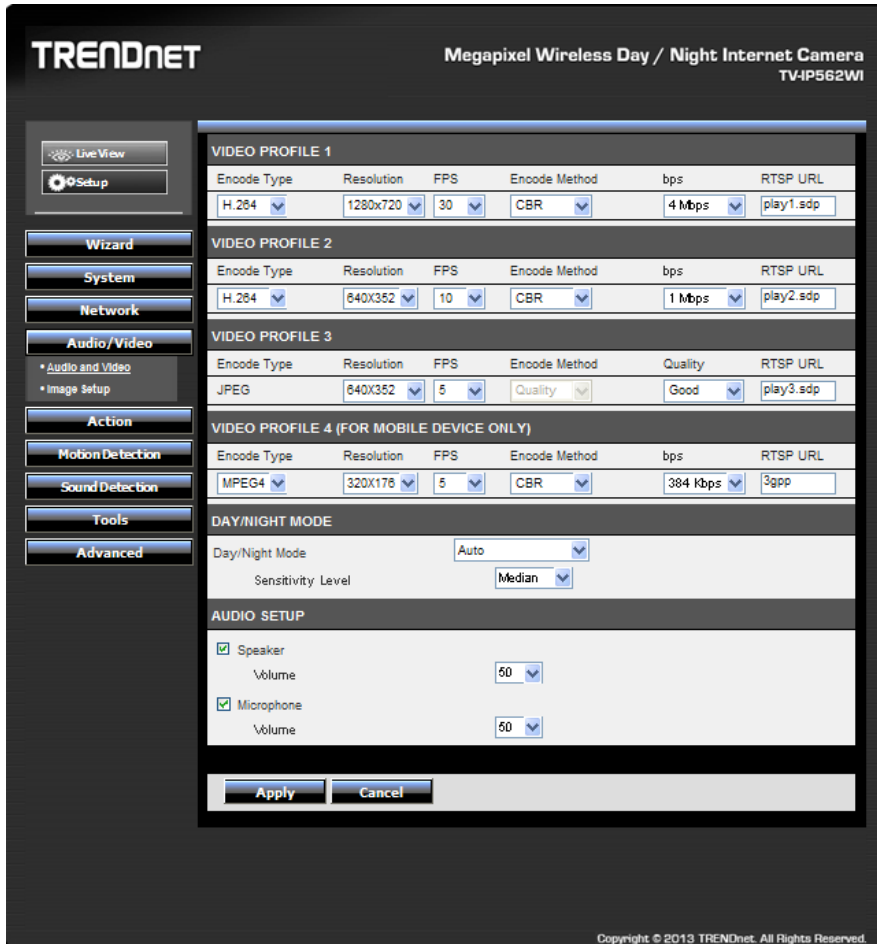

### Audio and Video

In the **Video Profile** sections, we can configure the following.

VIDEO PROFILE 1						
Encode Type	Resolution	FPS	Encode Method	bps	RTSP URL	
H.264	1280x720	30	CBR	4 Mbps	play1.sdp	
VIDEO PROFILE 2						
Encode Type	Resolution	FPS	Encode Method	bps	RTSP URL	
H.264	640x352	10	CBR	1 Mbps	play2.sdp	
VIDEO PROFILE 3						
Encode Type	Resolution	FPS	Encode Method	Quality	RTSP URL	
JPEG	640x352	5	Quality	Good	play3.sdp	
VIDEO PROFILE 4 (FOR MOBILE DEVICE ONLY)						
Encode Type	Resolution	FPS	Encode Method	bps	RTSP URL	
MPEG4	320x176	5	CBR	384 Kbps	3gpp	

Select the **Encode Type** option from the drop-down list. Encoding types that can be selected are **MPEG4**, **H.264**, and profile 3 will be on **JPEG** permanently.

Select the **Resolution** size option from the drop-down list. Resolutions that can be selected are **1280x720**, **640x352**, **320x176**, and **160x80**. The resolution of 1280x720 is only available on profiles 1 and 3.

Select the Frames Per Second (**FPS**) from the drop-down list. FPS speeds that can be selected are **30**, **15**, **10**, **6**, **5**, **3**, **2**, and **1**.

**Encode Method** – Two options available: CBR/Quality. CBR and Quality can be defined as such. When users choose the CBR encode method, the camera selects the bitrate as the first priority. The TV-IP562WI will adjust the image quality to fit the bitrate. When the user chooses the Quality encode method, the camera select the bitrate to fit the quality

Select the **Encode Mode** option from the drop-down list. Encoding modes that can be selected are Constant Bit Rate (**CBR**) and **Quality** and profile 3 will use the quality mode permanently.

After selecting **CBR** as the **Encode Mode**, select the Bits Per Second (**bps**) value. Options to choose from are between 64 Kbps and 4 Mbps. After selecting **Quality** as the **Encode**

**Mode**, select the **Quality** option. Options to choose from are **Low, Fair, Standard, Good, and Excellent**.

Users can also enter a custom **RSTP URL** in the space provided.

In the **Day/Night Mode** section, we can configure the following.

The screenshot shows a configuration panel titled "DAY/NIGHT MODE". Below the title, there is a label "Day/Night Mode" followed by a dropdown menu currently set to "Manual".

The camera allows users to record data in day and night mode. The camera has IR LED's for night mode. When selecting the Day mode, the viewing image is in normal color. However, when you use Night mode, the viewing image turns black and white. The reason for this is to create a clearer and smoother image. When you select the **Auto** mode, the Day/Night function is concealed.

**Please Note:** This allows you to set the camera to switch automatically from day to night mode (default) or to permanently set the color and Black/White operations. Also note, even when the camera is set to color mode, it will switch to Black/White night vision if there is no longer enough ambient light to support the color saturation.

Select the **Day/Night Mode** option from the drop-down list. Options to choose from are **Auto, Manual, Always day mode, Always night mode, and Schedule**. When selecting **Auto**, the camera will automatically switch between day and night modes depending on the light conditions. When selecting **Manual**, the user can manually toggle between day and night modes by clicking the  button on the **Live View** page. When selecting **Always day mode** or **Always night mode** the camera will stay on the mode selected even when the light conditions change. When selecting the **Schedule** option, the camera will toggle between day and night modes depending on the time schedule configured.

After selecting the **Auto** option as the **Day/Night Mode**, we can configure the following.

The screenshot shows a configuration panel titled "DAY/NIGHT MODE". Below the title, there is a label "Day/Night Mode" followed by a dropdown menu set to "Auto". Below that, there is a label "Sensitivity Level" followed by a dropdown menu set to "Median".

Select the **Sensitivity Level** option from the drop-down list. There are three main sensitivity point called **Brightest, Median, and Darkest**. In between these main sensitivity points are numerical sensitivity values ranging from **+1 to +7** between **Median** and **Brightest**, and numerical sensitivity values ranging from **-1 to -5** between **Median** and **Darkest**. Selecting the sensitivity level closer to the **Brightest** option, will switch the IR LEDs on **earlier** when the area becomes darker. Selecting the sensitivity level closer to the **Darkest** option, will switch the IR LEDs on **later** when the area becomes darker.

After selecting the **Schedule** option as the **Day/Night Mode**, we can configure the following.

The screenshot shows a configuration panel titled "DAY/NIGHT MODE". Below the title, there is a label "Day/Night Mode" followed by a dropdown menu set to "Schedule". Below that, there is a label "Day Time: From" followed by two input fields containing "6" and "0", then "to" followed by two input fields containing "18" and "0".

Enter the **Day Time** values in the spaces provided. First enter the starting hour and minute values next to the **From** option and then enter the ending hour and minute values next to the **to** option.

In the **Audio Setup** section, we can configure the following.

AUDIO SETUP	
<input checked="" type="checkbox"/> Speaker	
Volume	50
<input checked="" type="checkbox"/> Microphone	
Volume	50
<input type="button" value="Apply"/> <input type="button" value="Cancel"/>	

Tick the **Speaker** option to enable the audio feed from the camera to the PC. Tick the **Microphone** option to enable the audio feed from the PC to the camera. Select the **Volume** level for both selections. Click the **Apply** button to apply the modifications made.

## Image Setup

In the **Live Video** section, we can view the live video feed while we do image modifications in the **Image Settings** section.

LIVE VIDEO			
			
IMAGE SETTINGS			
Brightness	45	Saturation	55
Contrast	55	Hue	50
Black and White	<input type="checkbox"/>	Mirror	<input type="checkbox"/>
Flip	<input type="checkbox"/>	Frequency	Auto
White Balance	Auto	Slow Shutter	1/10 second
<input type="button" value="Reset to Default"/>			

Select the **Brightness**, **Saturation**, **Contrast**, and **Hue** values from the respective drop-down menus. Tick the **Black and White** option to change the image color to black and white. Tick the **Mirror** option to flip the video image horizontally. Tick the **Flip** option to flip the video image vertically for upside-down mounting. Select the video **Frequency** value from the drop-down list.

Select to enable or disable the auto **White Balance** feature. To enable the **Slow Shutter** feature, select one of the time values (**1/15 second**, **1/10 second**, **1/7.5 second** or **1/3.75 second**) from the drop-down list. Click the **Reset to Default** button to return the image settings to their default values.

## Action

The next category option available is **Action**. In the **Action** category we can configure the action that will be taken when recording is done.

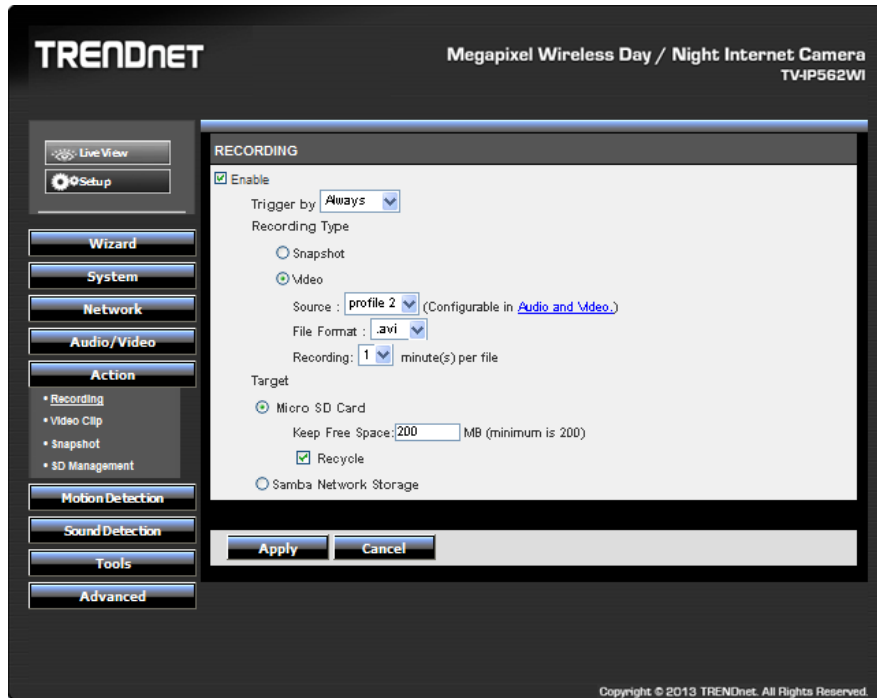

## Recording

This camera allows users to record video, based on a trigger event, and then save the video recording either on a micro SD card or on a Samba server shared folder. In the **Recording** section, we can configure the following.

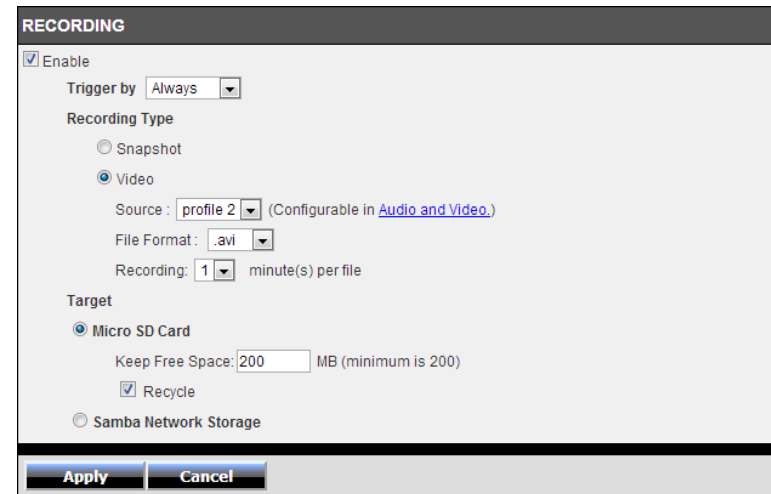

Tick the **Enable** option to enable the recording feature. Select the **Trigger by** option from the drop-down list. Options to choose from are **Motion**, **Schedule**, **Always**, and **Sound**. The parameters available for configuration will change depending on the selections made.



After selecting the **Motion** option as the **Trigger by** event, the following can be configured.

The screenshot shows a configuration box with the following elements:
 

- Enable
- Trigger by: **Motion** (dropdown menu)
- Schedule
- Day:  Sun  Mon  Tue  Wed  Thu  Fri  Sat
- Time: Start  :  End  :

Selecting **Motion**, will tell the camera only to record when motion is detected. Tick the **Schedule** option to only record motion at specific times of the week. Tick the **Day** and enter the **Start** and **End** times.

After selecting the **Schedule** option as the **Trigger by** event, the following can be configured.

The screenshot shows a configuration box with the following elements:
 

- Enable
- Trigger by: **Schedule** (dropdown menu)
- Day:  Sun  Mon  Tue  Wed  Thu  Fri  Sat
- Time: Start  :  End  :

Selecting **Schedule**, will tell the camera to record always within the scope of the schedule configured. Tick the **Day** and enter the **Start** and **End** times.

After selecting the **Always** option as the **Trigger by** event, the following can be configured.

The screenshot shows a configuration box with the following elements:
 

- Enable
- Trigger by: **Always** (dropdown menu)

Selecting **Always**, will tell the camera to record always.

After selecting the **Sound** option as the **Trigger by** event, the following can be configured.

The screenshot shows a configuration box with the following elements:
 

- Enable
- Trigger by: **Sound** (dropdown menu)
- Schedule
- Day:  Sun  Mon  Tue  Wed  Thu  Fri  Sat
- Time: Start  :  End  :

Selecting **Sound**, will tell the camera only to record when sound is detected. Tick the **Schedule** option to only record video when sound is detected at specific times of the week. Tick the **Day** and enter the **Start** and **End** times.

In the **Recording Type** section, we can configure the following.

The screenshot shows a configuration box titled "Recording Type" with the following elements:
 

- Pre-event recording  seconds (between 0 to 5 seconds)
- Post-event recording  seconds (between 0 to 60 seconds)

Enter the **Pre-event recording** and **Post-event recording** time values in the respective fields provided.

When selecting the **Snapshot** option, the following can be configured.

The screenshot shows a configuration box with the following elements:
 

- Snapshot
- Source : Profile 3 (Configurable in [Audio and Video](#).)
- Interval :  second(s)

Selecting this option will tell the camera to only take a snapshot (an image capture) of the video feed when the abovementioned criteria are met. Enter the **Interval** value in the space provided. The interval value means that a snapshot will be taken at every interval configured. Only **Profile 3** can be used for this selection.

When selecting the **Video** option, the following can be configured.

The screenshot shows the 'Video' configuration section. It includes a radio button for 'Video' which is selected. Below it, there are three fields: 'Source' set to 'profile 2' with a note '(Configurable in [Audio and Video.](#))', 'File Format' set to '.avi', and 'Recording' set to '1' minute(s) per file.

Selecting this option will tell the camera to record a video clip when the abovementioned criteria are met. Select the video profile (**Source**) that will be used for the recording. Select the **File Format** that the recording will be saved as. File formats available are AVI and MP4. Select the **Recording** clip time value between 1 and 6 minutes. This will split the total recording into smaller separate files for the duration of the recording.

In the **Target** section, we can configure the following.

The screenshot shows the 'Target' configuration section. It has a radio button for 'Micro SD Card' which is selected. Below it, there is a 'Keep Free Space' field set to '200' MB (minimum is 200) and a checked 'Recycle' checkbox.

After selecting **Micro SD Card** as the recording **Target**, the recording will be saved on the micro SD card installed in the camera. Enter the **Keep Free Space** value that is needed on the micro SD card. Tick the **Recycle** option to record until the space is filled on the micro SD card and then to record over the oldest recordings found on the card.

After selecting **Samba Network Storage** as the recording **Target**, the recording will be saved on the Samba network attached storage available on the local network.

The screenshot shows the 'Samba Network Storage' configuration section. It has a radio button for 'Samba Network Storage' which is selected. Below it, there are several fields: 'Server Address' (empty), 'Anonymous' (selected radio button), 'Account' (radio button), 'Share Folder' set to 'TV-IP562WI', 'Sub Folder' (empty), 'Keep Free Space' set to '200' MB (minimum is 200), and a checked 'Recycle' checkbox. At the bottom, there are 'Apply' and 'Cancel' buttons.

After selecting **Samba Network Storage** as the recording **Target**, the recording will be saved on the Samba network storage available on the network. Enter the **Samba Server Address** in the space provided. To connect to the Samba server as anonymous, select the **Anonymous** option. To connect the Samba server with a user account, select the **Account** option and enter the **Username** and **Password** in the spaces provided.

Enter the **Share Folder** name, **Sub Folder** name, and **Keep Free Space** information in the spaces provided. Tick the **Recycle** option to record until the space is filled on the Samba server account and then to record over the oldest recordings.

Click the **Apply** button to apply the modifications made.

Recording features:

Function		Recording	Video Clip	Snapshot	Note
Trigger Type	Always	Y	Y	Y	
	Motion	Y	Y	Y	
	Motion with Schedule	Y	Y	Y	
	Schedule	Y	Y	Y	
	Sound	Y	Y	Y	
	Sound with Schedule	Y	Y	Y	
Video profile Options		Profile 1/2/4 supported	Profile 1/2/4 supported	Profile 3 supported	* For recording and video clip, the available video profile options are 1/2/4. * For snapshot, the default video profile option is profile 3.
Target	E-Mail	N	Y	Y	

	FTP	N	Y	Y	
	SD card	Y	N	N	
	Samba	Y	N	N	
Recording Type	Pre-Event	Y	Y	Y	* It's only supported when trigger by Motion/Sound is activated. * Snapshot, it's activated using 6 snapshots only.
	Post-Event	Y	N	Y	* It's only supported when trigger by Motion/Sound is activated. * Snapshot, it's activated using 6 snapshots only.
	Real Time	Y	Y	Y	

## Video Clip

This camera allows users to record video clips and then send it to an FTP server or email the video to an email account. In the **Video Clip** section, we can configure the following.

**VIDEO CLIP**

Enable

Trigger by: Always

Video Clip Type

Source: profile 2 (Configurable in [Audio and Video](#))

File Format: .avi

Pre-event recording: 5 Seconds (between 0 to 5 seconds)

Maximum duration: 10 Seconds (between 5 to 10 seconds)

Target

FTP

E-mail

Apply Cancel

Tick the **Enable** option to enable the video clip feature. Select the **Trigger by** option from the drop-down list. Options to choose from are **Motion**, **Schedule**, **Always**, and **Sound**. The parameters available for configuration will change depending on the selections made.

After selecting the **Motion** option as the **Trigger by** event, the following can be configured.

Enable

Trigger by: Motion

Schedule

Day:  Sun  Mon  Tue  Wed  Thu  Fri  Sat

Time: Start 0 : 0 End 0 : 0

Selecting **Motion**, will tell the camera only to record when motion is detected. Tick the **Schedule** option to only record motion at specific times of the week. Tick the **Day** and enter the **Start** and **End** times.

After selecting the **Schedule** option as the **Trigger by** event, the following can be configured.

Time: Start 0 : 0 End 0 : 0

Day:  Sun  Mon  Tue  Wed  Thu  Fri  Sat

Trigger by: Schedule

Enable

Selecting **Schedule**, will tell the camera to record always within the scope of the schedule configured. Tick the **Day** and enter the **Start** and **End** times.

After selecting the **Always** option as the **Trigger by** event, the following can be configured.

Enable

Trigger by: Always

Selecting **Always**, will tell the camera to record always.

After selecting the **Sound** option as the **Trigger by** event, the following can be configured.

Enable

Trigger by: Sound

Schedule

Day:  Sun  Mon  Tue  Wed  Thu  Fri  Sat

Time: Start 0 : 0 End 0 : 0

Selecting **Sound**, will tell the camera only to record when sound is detected. Tick the **Schedule** option to only record video when sound is detected at specific times of the week. Tick the **Day** and enter the **Start** and **End** times.

In the **Video Clip Type** section, we can configure the following.

The screenshot shows the 'Video Clip Type' configuration panel. It includes a 'Source' dropdown menu set to 'profile 2', a 'File Format' dropdown menu set to '.avi', a 'Pre-event recording' input field with the value '5', and a 'Maximum duration' input field with the value '10'. Each input field has a small 'Seconds' label and a range in parentheses.

Select the video profile in the **Source** drop-down list to use. Since profile 3 is only for JPEG, it cannot be used here. Select the **File Format** that the video clip will be saved as. Options to choose from are AVI and MP4. Enter the **Pre-event recording** time value and the **Maximum duration** time value in the spaces provided.

In the **Target** section, we can configure the following.

The screenshot shows the 'Target' configuration panel with the 'FTP' radio button selected. Fields include 'FTP Server', 'Port' (set to 21), 'User Name', 'Password', 'Path', 'Filename Prefix', 'Interval' (set to 300), and 'Passive Mode' (checked). A 'Test' button is at the bottom.

In this section we can configure where the recorded video clip will be saved. Select **FTP** or **E-mail** as the target. After selecting **FTP** as the **Target**, enter the **FTP Server** address, **Port** number, **User Name**, **Password**, **Path**, **Filename Prefix**, and **Interval** information in the spaces provided. Tick the **Passive Mode** option to enable the passive mode feature. Click the **Test** button to test the FTP connection.

After selecting **E-mail** as the **Target**, the following will be available.

The screenshot shows the 'Target' configuration panel with the 'E-mail' radio button selected. Fields include 'Recipient E-mail Address', 'SMTP Mail Server', 'Port' (set to 465), 'User Name', 'Password', 'Sender E-mail Address', 'Interval' (set to 600), and 'Use SSL-TLS' (set to 'SSL-TLS'). A 'Test' button is at the bottom.

Enter the **Recipient E-mail Address**, **SMTP Mail Server** address, **Port** number, **User Name**, **Password**, **Sender E-mail Address**, and **Interval** information in the spaces provided. Select the **SSL-TLS** option that will be used. Options to choose from are **None**, **SSL-TLS**, and **STARTTLS**. Click the **Test** button to test the E-mail connection.

Click the **Apply** button to apply the modifications made.

## Snapshot

Snapshots can be taken by this camera based on the trigger by event. In the **Snapshot** section, we can configure the following.

The screenshot shows the 'SNAPSHOT' configuration window. The 'Enable' checkbox is checked. The 'Trigger by' dropdown menu is set to 'Always'. Under 'Snapshot Type', the source is 'Profile 3 (configurable in [Audio and Video](#))'. Under 'Target', both 'FTP' and 'E-mail' checkboxes are unchecked. At the bottom, there are 'Apply' and 'Cancel' buttons.

Tick the **Enable** option to enable the snapshot feature. Select the **Trigger by** option from the drop-down list. Options to choose from are **Motion**, **Schedule**, **Always**, and **Sound**. The parameters available for configuration will change depending on the selections made.

After selecting the **Motion** option as the **Trigger by** event, the following can be configured.

The screenshot shows the 'SNAPSHOT' configuration window. The 'Enable' checkbox is checked. The 'Trigger by' dropdown menu is set to 'Motion'. The 'Schedule' checkbox is checked. Under 'Day', all days from Sun to Sat are checked. Under 'Time', the start and end times are both set to 0:00.

Selecting **Motion**, will tell the camera only to take snapshots when motion is detected. Tick the **Schedule** option to only take snapshots for motion at specific times of the week. Tick the **Day** and enter the **Start** and **End** times.

After selecting the **Schedule** option as the **Trigger by** event, the following can be configured.

The screenshot shows the 'SNAPSHOT' configuration window. The 'Enable' checkbox is checked. The 'Trigger by' dropdown menu is set to 'Schedule'. Under 'Day', all days from Sun to Sat are checked. Under 'Time', the start and end times are both set to 0:00.

Selecting **Schedule**, will tell the camera to always take snapshots within the scope of the schedule configured. Tick the **Day** and enter the **Start** and **End** times.

After selecting the **Always** option as the **Trigger by** event, the following can be configured.

The screenshot shows the 'SNAPSHOT' configuration window. The 'Enable' checkbox is checked. The 'Trigger by' dropdown menu is set to 'Always'.

Selecting **Always**, will tell the camera to always take snapshots.

After selecting the **Sound** option as the **Trigger by** event, the following can be configured.

The screenshot shows the 'SNAPSHOT' configuration window. The 'Enable' checkbox is checked. The 'Trigger by' dropdown menu is set to 'Sound'. The 'Schedule' checkbox is checked. Under 'Day', all days from Sun to Sat are checked. Under 'Time', the start and end times are both set to 0:00.

Selecting **Sound**, will tell the camera only to take snapshots when sound is detected. Tick the **Schedule** option to only take snapshots when sound is detected at specific times of the week. Tick the **Day** and enter the **Start** and **End** times.

In the **Snapshot Type** section, we can configure the following.

Only **Profile 3** can be used to take snapshots.

In the **Target** section, we can configure the following.

In this section we can configure where the snapshot will be saved. Select **FTP** or **E-mail** as the target.

After selecting **FTP** as the **Target**, the following will be available.

Enter the **FTP Server** address, **Port** number, **User Name**, **Password**, **Path**, **Filename Prefix**, and **Interval** information in the spaces provided. Tick the **Passive Mode** option to enable the passive mode feature. Click the **Test** button to test the FTP connection.

After selecting **E-mail** as the **Target**, the following will be available.

The screenshot shows a configuration window titled "Target". It has two radio buttons: "FTP" (unchecked) and "E-mail" (checked). Below are several input fields and a dropdown menu:

- Recipient E-mail Address: [text input]
- SMTP Mail Server: [text input]
- Port: 465 (range 1 to 65535)
- User Name: [text input]
- Password: [text input]
- Sender E-mail Address: [text input]
- Interval: 600 Seconds (range 30 to 86400 seconds)
- Use SSL-TLS: SSL-TLS (dropdown menu)

At the bottom of the form are three buttons: "Apply", "Cancel", and "Test".

Enter the **Recipient E-mail Address**, **SMTP Mail Server** address, **Port** number, **User Name**, **Password**, **Sender E-mail Address**, and **Interval** information in the spaces provided. Select the **SSL-TLS** option that will be used. Options to choose from are **None**, **SSL-TLS**, and **STARTTLS**. Click the **Test** button to test the E-mail connection.

Click the **Apply** button to apply the modifications made.

## SD Management

On this page the micro SD card can be managed. In the **SD Management** section, we can configure the following.

The screenshot shows the "SD MANAGEMENT" section of a web interface. It displays the following information:

- Micro SD Card: TV-IP562WI /
- SD Status: Unavailable
- Files per Page: 5 (dropdown menu)
- Refresh button
- Pages: 0 (dropdown menu) of
- Delete button (with a checkbox)
- Name and Size columns for a file list
- Format SD Card button
- Total: KB, Used: KB, Free: KB

In this section the **SD Status**, Folder **Name**, Folder **Size**, **Total** Space, **Total Space Used**, and **Total Space Free** information will be displayed. Select the **Files per Page** option from the drop-down list to view a certain amount of files per page. Select the **Pages** option from the drop-down list to view a certain page's information, when multiple pages exist. Select a folder's or file's **checkbox** and click the **Delete** button to manually remove a folder or file from the micro SD card. Click the **Format SD Card** button to completely reformat the micro SD card.

**Note:** When formatting the SD card, all files and folders will be removed from the micro SD card and cannot be recovered.



## Motion Detection

The next category option available is **Motion Detection**. In the **Motion Detection** category we can configure the motion detection area and settings for this camera.

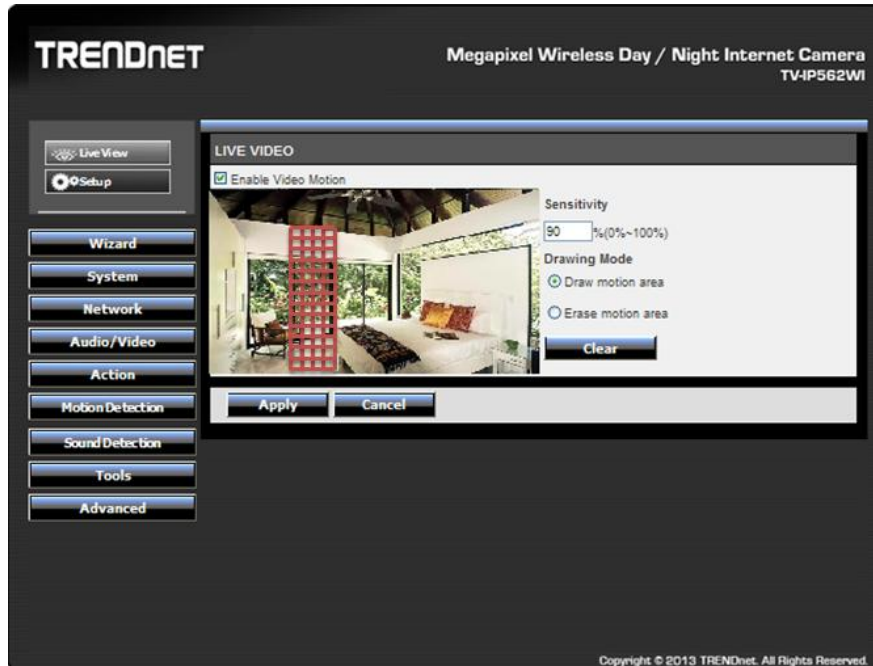

Tick the **Enable Video Motion** option to enable the motion detection feature for this camera. When the **Draw motion area** option is selected, in the live video feed block, use the left mouse button to draw an area that will be used for motion detection. The area will be highlighted with **Red Blocks**. When the **Erase motion area** option is selected, in the live video feed block, use the left mouse button to erase the area that was used for motion detection. Enter the **Sensitivity** value in the space provided. Click the **Clear** button to completely remove all the red blocks from the video feed.

Click the **Apply** button to apply the modifications made.

## Sound Detection

The next category option available is **Sound Detection**. In the **Sound Detection** category we can configure the sound detection settings for this camera.

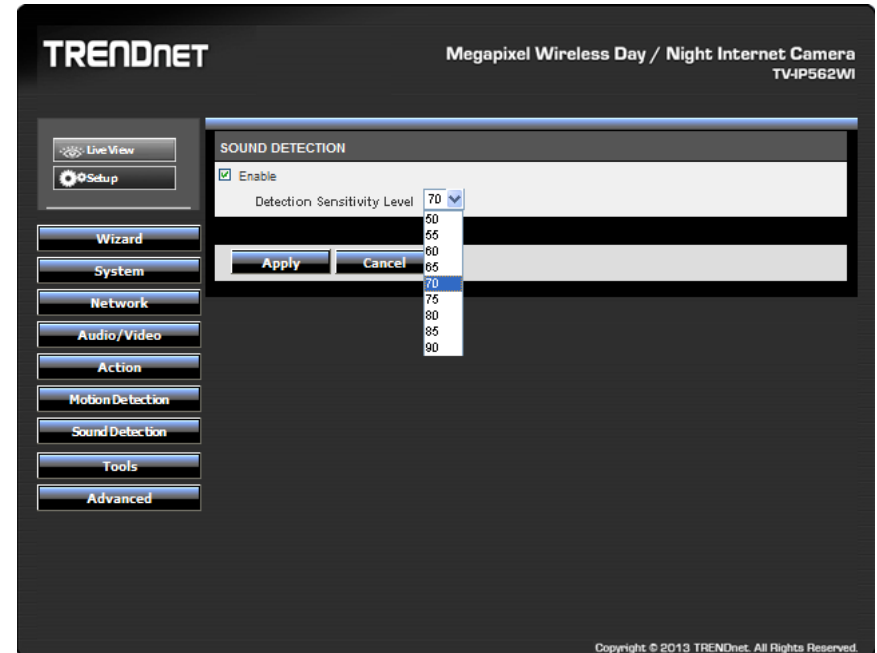

Tick the **Enable** button to enable the sound detection feature of this camera. Select the sound **Detection Sensitivity Level** value from the drop-down list provided. Configure the sensitivity levels to higher settings in noisy environments. Click the **Apply** button to apply the modifications made.

## Tools

The next category option available is **Tools**. In the **Tools** category we can backup and restore configuration files, reset or reboot the camera, and perform a firmware update.

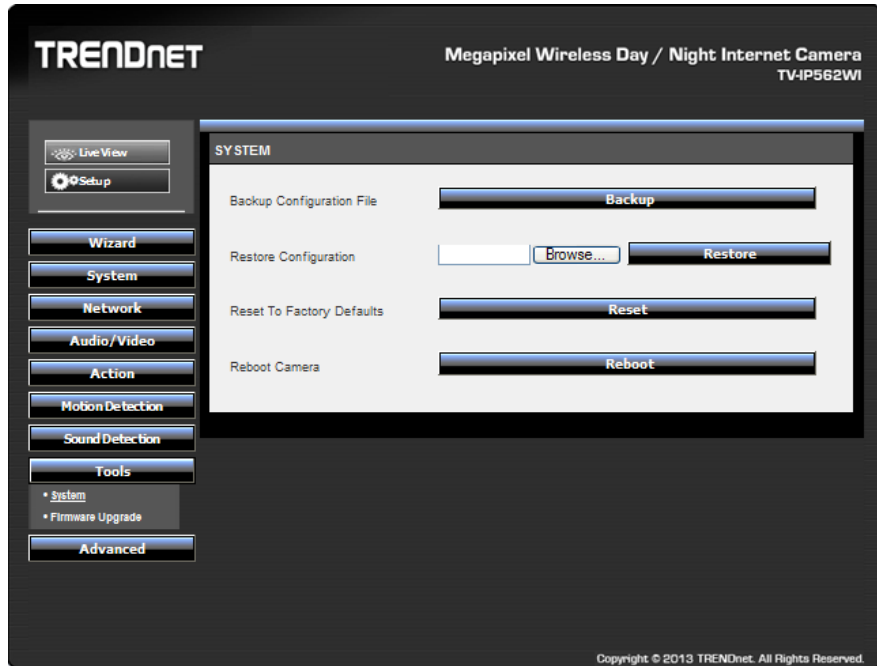

## System

In the **System** section we can configure the following.

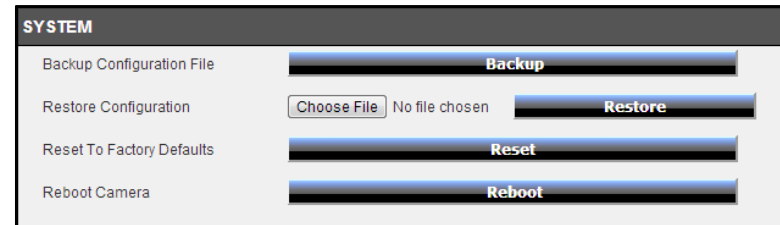

Click the **Backup** button to back up the camera configuration file that will be saved on the local computer. When you backup the configure file, a dialog box will pop up. Enter a key. This will password-protect the configuration file. You will need to enter the same key when you restore the configure file to the camera.

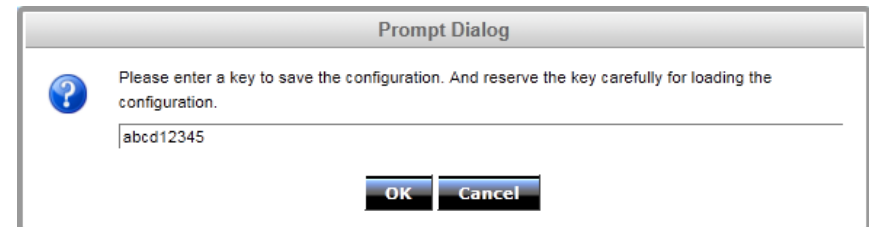

Click the **Choose File** button to navigate to the backed up configuration file on the local computer and then click the **Restore** button to restore the configuration file. You will need to enter the same key that typed in when you backed up the configuration file.

Click the **Reset** button to restore the camera to its factory default settings. **Note:** All configurations that were done on this camera will be lost and the camera will return to its factory default configuration.

Click the **Reboot** button to simply reboot the camera.

## Firmware Update

In the **Firmware** section we can view and configure the following.

FIRMWARE INFORMATION	
Current Firmware Version:	1.0.0
Current Firmware Build Number:	3218

In the **Firmware Information** section, information regarding the current running firmware version will be displayed.

In the **Firmware Upgrade** section, click the **Choose File** button to navigate to the saved firmware file, located on the local computer, and then click the **Upload** button to upload that firmware to the camera. The camera will then use this firmware file to upgrade the firmware of the camera.

**Note:** To find the latest firmware available for this camera, visit the TRENDnet website.

## Advanced

The next category option available is **Advanced**. In the **Advanced** category we can view more detailed information about the camera as well as the system log.

The screenshot displays the TRENDnet web interface for a Megapixel Wireless Day / Night Internet Camera (TV-IP562WI). The 'Advanced' section is active, showing the 'INFORMATION' tab. The interface includes a sidebar with navigation options: Live View, Setup, Wizard, System, Network, Audio/Video, Action, Motion Detection, Sound Detection, Tools, and Advanced. The 'Advanced' section is expanded to show 'Device Info' and 'Log'. The main content area displays the following information:

INFORMATION	
Camera Name	TV-IP562WI
Time & Date	2013/1/3 23:32:02
Firmware Version	1.0.0
Firmware Build Number	3319
MAC Address	EE:EE:EEEE:EEEE:EE
IPv4 Address	192.168.10.30
IPv4 Subnet Mask	255.255.255.0
IPv4 Default Gateway	192.168.10.1
IPv4 Primary DNS	192.168.10.1
IPv4 Secondary DNS	
Search Domain	
IPv6 Address/Prefix Length	fe80::daeb:97ff:fed2:6c68/64
IPv6 Default Gateway	
IPv6 Primary DNS	
IPv6 Secondary DNS	
PPPoE Status	Disabled
DDNS Status	Disabled

Copyright © 2013 TRENDnet. All Rights Reserved.

## Device Info

In the **Information** section we can view more detailed information about the camera's configuration.

**TRENDnet** Megapixel Wireless Day / Night Internet Camera  
TV-IP562WI

Live View  
Setup

Wizard  
System  
Network  
Audio/Video  
Action  
Motion Detection  
Sound Detection  
Tools  
Advanced  
• Device Info  
• Log

**INFORMATION**

Camera Name	TV-IP562WI
Time & Date	2013/1 /3 23:32:02
Firmware Version	1.0.0
Firmware Build Number	3319
MAC Address	EE:EE:EEEE:EEEE
IPv4 Address	192.168.10.30
IPv4 Subnet Mask	255.255.255.0
IPv4 Default Gateway	192.168.10.1
IPv4 Primary DNS	192.168.10.1
IPv4 Secondary DNS	
Search Domain	
IPv6 Address/Prefix Length	fe80::dae:97ff:fed2:6c68:64
IPv6 Default Gateway	
IPv6 Primary DNS	
IPv6 Secondary DNS	
PPPoE Status	Disabled
DDNS Status	Disabled

Copyright © 2013 TRENDnet. All Rights Reserved.

## Log

In the **Current Log** section we can view a list of system log entries that was generated based on events that occurred during the runtime of this camera.

**CURRENT LOG**

2013-01-01 04:04:34	admin, 192.168.1.52	is streaming video.
2013-01-01 04:05:59	admin, 192.168.1.52	is streaming video.
2013-01-01 05:07:57	admin, 192.168.1.52	is streaming video.
2013-01-03 23:31:53	admin, 192.168.1.33	is streaming video.

Clear Download

Click the **Clear** button to remove all the log entries from the table.

Click the **Download** button export the log table to a text file and then save it to the local computer.

## TRENDnetVIEW Pro Software

Click **Autorun**.



Click on the link, **Install TRENDnetVIEW Pro Software**, to install it.

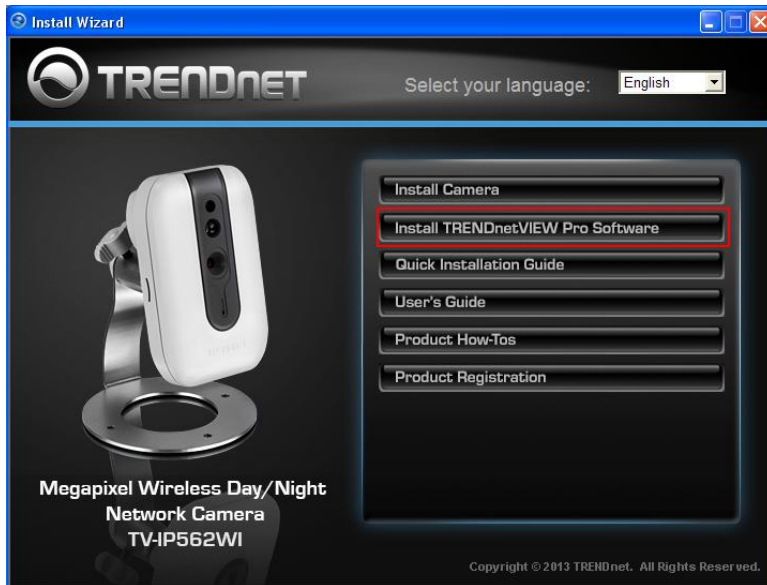

### Using the proprietary-based configuration interface

This section describes the how to setup a camera using the TRENDnetVIEW Pro 2.0 camera monitoring software. To install TRENDnetVIEW Pro 2.0 on a system running Windows, launch the TRENDnetVIEW Pro 2.0 installation software on the installation CD-ROM and follow the setup instructions. Once the software is installed, the TRENDnet View Pro 2.0 camera monitoring utility is ready for use. Add up to 32 network cameras to monitor using the software. Additional software, TRENDnet IPView Pro Player software is also installed. The TRENDnetVIEW Pro Player is used for playing recorded video from cameras that have been configured to save recorded files.

### Running the Software

When the wizard starts, you have the option to select a language. The default is **English**. Alternatively, there are 13 other languages to choose from. Select the one that best suits your needs.

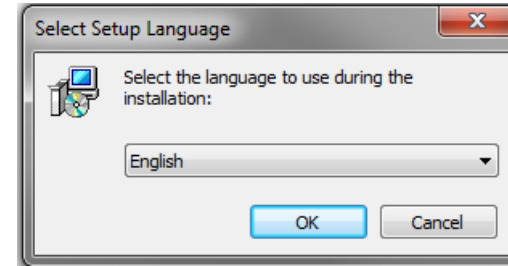

The next screen will display the Welcome screen. Click **Next** to continue.

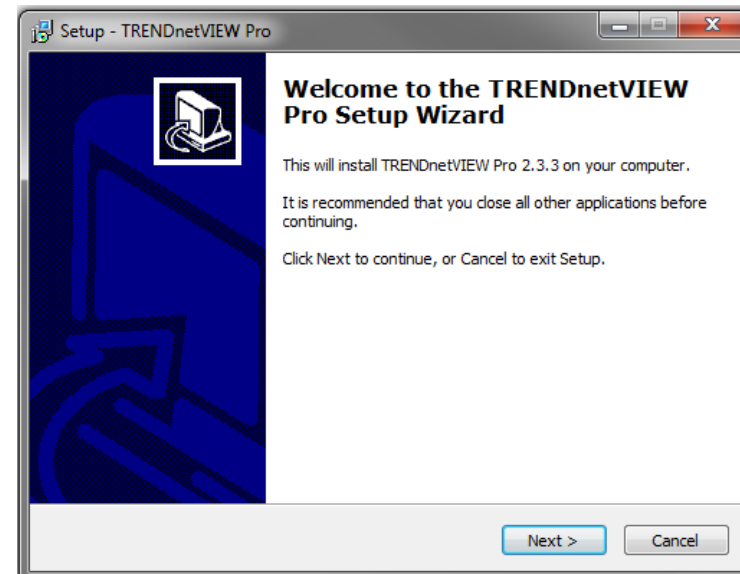

Please view the **TRENDnetVIEW Pro User Guide** for more details on the software.

## How to setup/access the camera remotely

The Dynamic DNS connection can be configured on the camera itself or the home router. An account from any of the listed Dynamic DNS providers is required prior to this operation.

### Configure Dynamic DNS on your Camera

1. Go to camera's **Dynamic DNS** page. Tick **Enable** to activate the feature. Then select a Dynamic DNS provider from the list. After selecting the Dynamic DNS provider, the domain name will be entered into the **Server Address** field.

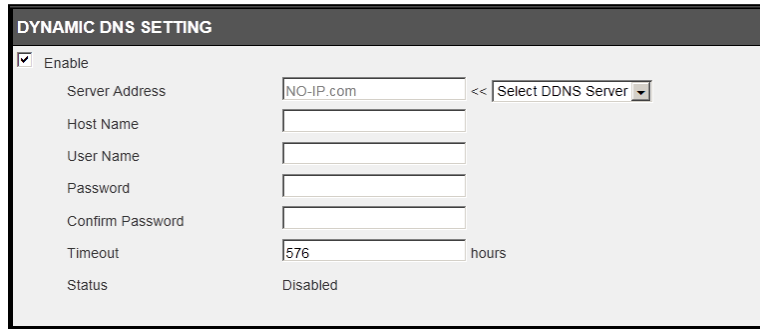

2. Enter Dynamic DNS' Host Name, User Name and Password. Re-enter the password to confirm it.

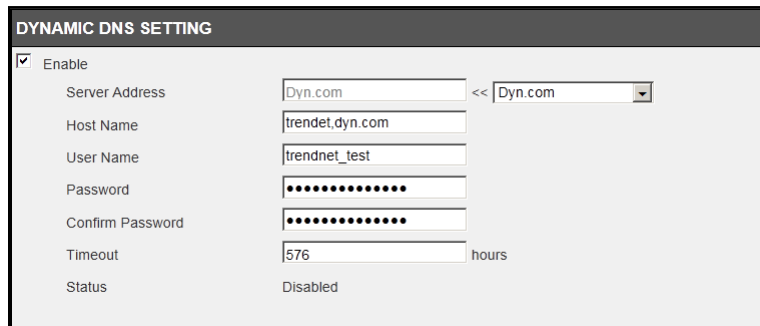

3. In the **Port Number** section, assign an HTTP port of the camera. The default HTTP Port on the camera is 80. The example shows above is using port number 9000.

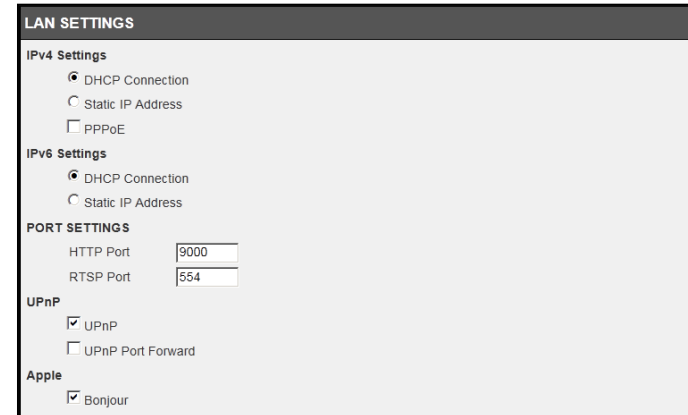

4. Open the router's Web configuration page. (In the example, TRENDnet's TEW-651BR Wireless N Home Router is used)

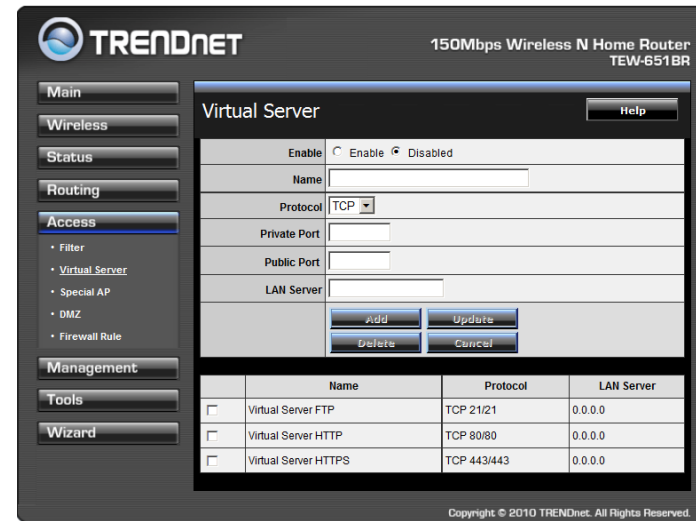

	Name	Protocol	LAN Server
<input type="checkbox"/>	Virtual Server FTP	TCP 21/21	0.0.0.0
<input type="checkbox"/>	Virtual Server HTTP	TCP 80/80	0.0.0.0
<input type="checkbox"/>	Virtual Server HTTPS	TCP 443/443	0.0.0.0

- Go to **Access > Virtual Server\*** section and create a new entry.

**Enable:** Click **Enable**

**Name:** Enter the application name (eg. CameraName)

**Protocol:** Select **TCP**

**Private Port:** The HTTP port that you assign on your Camera.

**Public Port:** The port used on remote side to access to your Camera.

**LAN Server:** The local IP address of your Camera.

Then click **Add** to add the application.

\* Please refer to your router's user's manual for detail **Virtual Server** setting. Some router might use **Port Forwarding** or **Special applications** for this function. The setup steps should be very similar.

	Name	Protocol	LAN Server
<input type="checkbox"/>	Virtual Server FTP	TCP 21/21	0.0.0.0
<input type="checkbox"/>	Virtual Server HTTP	TCP 80/80	0.0.0.0
<input type="checkbox"/>	Virtual Server HTTPS	TCP 443/443	0.0.0.0
<input checked="" type="checkbox"/>	TV-IP562WI	TCP 9000/9000	192.168.10.30

- Open another web browser and enter your DDNS domain and camera's port number. <http://yourDomainName:PortNumber>



- Camera's login page will appear.

**Configure DDNS on your router**

- Go to Camera's **NetWork → Ports Settings** section, assign a HTTP port for your camera and click **Apply**.

- Login to your router's web configuration page. Find the **Dynamic DNS** configuration section.

3. Enable DDNS, fill out the following information and then click **Apply**.

4. Go to **Virtual Server\*** section and create a new entry.

**Enable:** Click **Enable**

**Name:** Enter the application name (eg. Camera Name)

**Protocol:** Select **TCP**

**Private Port:** The HTTP port that you assign on your Camera.

**Public Port:** The port used on remote side to access to your Camera.

**LAN Server:** The local IP address of your Camera.

Click **Add** to add the application.

\* Please refer to your router's user's manual for detail **Virtual Server** setting. Some router might use **Port Forwarding** or **Special applications** for this function. The setup steps should be very similar.

	Name	Protocol	LAN Server
<input type="checkbox"/>	Virtual Server FTP	TCP 21/21	0.0.0.0
<input type="checkbox"/>	Virtual Server HTTP	TCP 80/80	0.0.0.0
<input type="checkbox"/>	Virtual Server HTTPS	TCP 443/443	0.0.0.0
<input checked="" type="checkbox"/>	TV-IP562WI	TCP 9000/9000	192.168.10.30

5. Open another web browser and enter your DDNS domain and camera's port number.

<http://yourDomainName:PortNumber>



6. The camera login page will appear.



## Troubleshooting

### 1. The Power LED and Ethernet Activity LED do not light up.

The power supply or camera might be faulty. Check that the connection to both the power source and the terminal on the back of the camera are secure and that you are using the provided power supply. If the camera is otherwise functioning correctly, the LEDs might have been disabled in the configuration. See the section of this guide on Configuration of System settings.

### 14. The camera can't be accessed or access is slow.

There might be a problem with the network cable. To confirm that the cables are working, ping the address of a known device on the network. If the cabling is OK and your network is reachable, you should receive a reply similar to the following (...bytes = 32 time = 2 ms).

Another possible problem may be that the network device such as a hub or switch utilized by the Network Camera is not functioning properly. Please confirm the power for the devices are well connected and functioning properly.

### 15. The camera can be accessed locally but not remotely.

This might be caused by a firewall. Check the Internet firewall with your system administrator. The firewall may need to have some settings changed in order for the Network Camera to be accessible outside your local LAN. For more information, please refer to the section about installing your camera behind a router.

Make sure that the Network Camera isn't conflicting with any Web server you may have running on your network.

The default router setting might be a possible reason. Check that the configuration of the router settings allow the Network Camera to be accessed outside your local LAN.

### 16. White vertical lines appear on the image from the camera.

It could be that the CMOS sensor (a square panel situated behind the lens that measures the light signals and changes it into a digital format so your computer can present it into an image that you are familiar with) has become overloaded when it has been exposed to bright lights such as direct exposure to sunlight or halogen lights. Reposition the Network Camera into a more shaded area immediately as prolonged exposure to bright lights will damage the CMOS sensor.

### 17. The camera images are 'noisy'.

Often if the camera is in a low-light environment, the images can contain a lot of noise. Try enabling Night mode and see if that improves the image quality. Otherwise, try to use the camera in a location where there is a bit more light.

### 18. The camera images are of poor quality.

Make sure that your computer's display properties are set to at least 16-bit color. Using 16 or 256 colors on your computer will produce dithering artifacts in the image, making the image look as if it is of poor quality.

Try also adjusting the brightness, contrast, saturation, light frequency and anti-flicker controls on the Video Settings under the Configuration menu. You may also consider adjusting the resolution of the camera and the compression rate to improve the image.

### 19. Video can't be viewed through the web browser interface.

ActiveX might be disabled. If you are viewing the images from Internet Explorer make sure ActiveX has been enabled in the Internet Options menu. You may also need to change the security settings on your browser to allow the ActiveX plugin to be installed.

If you are using Internet Explorer with a version number lower than 6, then you will need to upgrade your Web browser software in order to view the streaming video transmitted by the Network Camera. Try also viewing the video using Java. Ensure that you have the latest version of Java installed before you do. Go to [www.java.com](http://www.java.com) for more information.

**Federal Communication Commission Interference Statement**

This equipment has been tested and found to comply with the limits for a Class B digital device, pursuant to Part 15 of the FCC Rules. These limits are designed to provide reasonable protection against harmful interference in a residential installation. This equipment generates, uses and can radiate radio frequency energy and, if not installed and used in accordance with the instructions, may cause harmful interference to radio communications. However, there is no guarantee that interference will not occur in a particular installation. If this equipment does cause harmful interference to radio or television reception, which can be determined by turning the equipment off and on, the user is encouraged to try to correct the interference by one of the following measures:

Reorient or relocate the receiving antenna.

Increase the separation between the equipment and receiver.

Connect the equipment into an outlet on a circuit different from that to which the receiver is connected.

Consult the dealer or an experienced radio/TV technician for help.

This device complies with Part 15 of the FCC Rules. Operation is subject to the following two conditions: (1) This device may not cause harmful interference, and (2) this device must accept any interference received, including interference that may cause undesired operation.

FCC Caution: Any changes or modifications not expressly approved by the party responsible for compliance could void the user's authority to operate this equipment.

IEEE 802.11b or 802.11g operation of this product in the U.S.A. is firmware-limited to channels 1 through 11.

**IMPORTANT NOTE:****FCC Radiation Exposure Statement:**

This equipment complies with FCC radiation exposure limits set forth for an uncontrolled environment. This equipment should be installed and operated with minimum distance 20cm between the radiator & your body.

This transmitter must not be co-located or operating in conjunction with any other antenna or transmitter.

**Europe – EU Declaration of Conformity**

This device complies with the essential requirements of the R&TTE Directive 1999/5/EC. The following test methods have been applied in order to prove presumption of conformity with the essential requirements of the R&TTE Directive 1999/5/EC:

EN 60950-1:2006+A11:2009+A1:2010+A12:2011

Safety of Information Technology Equipment

EN 62311: 2008

Assessment of electronic and electrical equipment related to human exposure restrictions for electromagnetic fields (0 Hz-300 GHz)

(IEC 62311:2007 (Modified))

EN 300 328 V1.7.1: (2006-10)

Electromagnetic compatibility and Radio spectrum Matters (ERM); Wideband Transmission systems; Data transmission equipment operating in the 2,4 GHz ISM band and using spread spectrum modulation techniques; Harmonized EN covering essential requirements under article 3.2 of the R&TTE Directive

EN 301 489-1 V1.9.2: 2011

Electromagnetic compatibility and Radio Spectrum Matters (ERM); ElectroMagnetic Compatibility (EMC) standard for radio equipment and services; Part 1: Common technical requirements

EN 301 489-17 V2.2.1 (2009-05)

Electromagnetic compatibility and Radio spectrum Matters (ERM); ElectroMagnetic Compatibility (EMC) standard for radio equipment and services; Part 17: Specific conditions for 2,4 GHz wideband transmission systems

This device is a 2.4 GHz wideband transmission system (transceiver), intended for use in all EU member states and EFTA countries, except in France and Italy where restrictive use applies.

In Italy the end-user should apply for a license at the national spectrum authorities in order to obtain authorization to use the device for setting up outdoor radio links and/or for supplying public access to telecommunications and/or network services.

This device may not be used for setting up outdoor radio links in France and in some areas the RF output power may be limited to 10 mW EIRP in the frequency range of 2454 – 2483.5 MHz. For detailed information the end-user should contact the national spectrum authority in France.



This device is designed to provide uninterrupted monitoring and/or recording. This device does not off power management functionality such as Off mode or Standby mode.

**IMPORTANT NOTE:**

**NCC AND FCC Warning Statement**









**FOR COUNTRY CODE SELECTION USAGE (WLAN DEVICES)**









Note: This country code selection is for non-US models only and is not available to all US models. Per FCC regulation, all WiFi products marketed in the US must be fixed to US operation channels only.

**以下警語適用台灣地區**

經型式認證合格之低功率射頻電機，非經許可，公司、商號或使用者均不得擅自變更頻率、加大功率或變更原設計之特性及功能。

低功率射頻電機之使用不得影響飛航安全及干擾合法通信；經發現有干擾現象時，應立即停用，並改善至無干擾時方得繼續使用。前項合法通信，指依電信法規定作業之無線電通信。低功率射頻電機須忍受合法通信或工業、科學及醫療用電波輻射性電機設備之干擾。

 Český [Czech]	TRENDnet tímto prohlašuje, že tento TV-IP562WI je ve shodě se základními požadavky a dalšími příslušnými ustanoveními směrnice 1999/5/ES.
 Dansk [Danish]	Undertegnede TRENDnet erklærer herved, at følgende udstyr TV-TV-IP562WI overholder de væsentlige krav og øvrige relevante krav i direktiv 1999/5/EF.
 Deutsch [German]	Hiermit erklärt TRENDnet, dass sich das Gerät TV-IP562WI in Übereinstimmung mit den grundlegenden Anforderungen und den übrigen einschlägigen Bestimmungen der Richtlinie 1999/5/EG befindet.
 Eesti [Estonian]	Käesolevaga kinnitab TRENDnet seadme TV-IP562WI vastavust direktiivi 1999/5/EÜ põhinõuetele ja nimetatud direktiivist tulenevatele teistele asjakohastele sätetele.
 English	Hereby, TRENDnet, declares that this TV-IP562WI is in compliance with the essential requirements and other relevant provisions of Directive 1999/5/EC.
 Español [Spanish]	Por medio de la presente TRENDnet declara que el TV-IP562WI cumple con los requisitos esenciales y cualesquiera otras disposiciones aplicables o exigibles de la Directiva 1999/5/CE.
 Ελληνική [Greek]	ΜΕ ΤΗΝ ΠΑΡΟΥΣΑ TRENDnet ΔΗΛΩΝΕΙ ΟΤΙ ΤΟ TV-IP562WI ΣΥΜΜΟΡΦΩΝΕΤΑΙ ΠΡΟΣ ΤΙΣ ΟΥΣΙΩΔΕΙΣ ΑΠΑΙΤΗΣΕΙΣ ΚΑΙ ΤΙΣ ΛΟΙΠΕΣ ΣΧΕΤΙΚΕΣ ΔΙΑΤΑΞΕΙΣ ΤΗΣ ΟΔΗΓΙΑΣ 1999/5/ΕΚ.
 Français [French]	Par la présente TRENDnet déclare que l'appareil TV-IP562WI est conforme aux exigences essentielles et aux autres dispositions pertinentes de la directive 1999/5/CE.
 Italiano [Italian]	Con la presente TRENDnet dichiara che questo TV-IP562WI è conforme ai requisiti essenziali ed alle altre disposizioni pertinenti stabilite dalla direttiva 1999/5/CE.
Latviski [Latvian]	Ar šo TRENDnet deklarē, ka TV-IP562WI atbilst Direktīvas 1999/5/EK būtiskajām prasībām un citiem ar to saistītajiem

	noteikumiem.
Lietuvių [Lithuanian]	Šiuo TRENDnet deklaruoja, kad šis TV-IP562WI atitinka esminius reikalavimus ir kitas 1999/5/EB Direktyvos nuostatas.
 Nederlands [Dutch]	Hierbij verklaart TRENDnet dat het toestel TV-IP562WI in overeenstemming is met de essentiële eisen en de andere relevante bepalingen van richtlijn 1999/5/EG.
 Malti [Maltese]	Hawnhekk, TRENDnet, jiddikjara li dan TV-IP562WI jikkonforma mal-ħtiġijiet essenzjali u ma provvedimenti oħrajn rilevanti li hemm fid-Dirrettiva 1999/5/EC.
 Magyar [Hungarian]	Alulírott, TRENDnet nyilatkozom, hogy a TV-IP562WI megfelel a vonatkozó alapvető követelményeknek és az 1999/5/EC irányelv egyéb előírásainak.
 Polski [Polish]	Niniejszym TRENDnet oświadcza, że TV-IP562WI jest zgodny z zasadniczymi wymogami oraz pozostałymi stosownymi postanowieniami Dyrektywy 1999/5/EC.
 Português [Portuguese]	TRENDnet declara que este TV-IP562WI está conforme com os requisitos essenciais e outras disposições da Directiva 1999/5/CE.
 Slovensko [Slovenian]	TRENDnet izjavlja, da je ta TV-IP562WI v skladu z bistvenimi zahtevami in ostalimi relevantnimi določili direktive 1999/5/ES.
Slovensky [Slovak]	TRENDnet týmto vyhlasuje, že TV-IP562WI spĺňa základné požiadavky a všetky príslušné ustanovenia Smernice 1999/5/ES.
 Suomi [Finnish]	TRENDnet vakuuttaa täten että TV-IP562WI tyyppinen laite on direktiivin 1999/5/EY oleellisten vaatimusten ja sitä koskevien direktiivin muiden ehtojen mukainen.
 Svenska [Swedish]	Härmed intygar TRENDnet att denna TV-IP562WI står i överensstämmelse med de väsentliga egenskapskrav och övriga relevanta bestämmelser som framgår av direktiv 1999/5/EG.

## Limited Warranty

TRENDnet warrants its products against defects in material and workmanship, under normal use and service, for the following lengths of time from the date of purchase.

### TV-IP562WI – 3 Years Warranty

AC/DC Power Adapter, Cooling Fan, and Power Supply carry 1 year warranty.

If a product does not operate as warranted during the applicable warranty period, TRENDnet shall reserve the right, at its expense, to repair or replace the defective product or part and deliver an equivalent product or part to the customer. The repair/replacement unit's warranty continues from the original date of purchase. All products that are replaced become the property of TRENDnet. Replacement products may be new or reconditioned. TRENDnet does not issue refunds or credit. Please contact the point-of-purchase for their return policies.

TRENDnet shall not be responsible for any software, firmware, information, or memory data of customer contained in, stored on, or integrated with any products returned to TRENDnet pursuant to any warranty.

There are no user serviceable parts inside the product. Do not remove or attempt to service the product by any unauthorized service center. This warranty is voided if (i) the product has been modified or repaired by any unauthorized service center, (ii) the product was subject to accident, abuse, or improper use (iii) the product was subject to conditions more severe than those specified in the manual.

Warranty service may be obtained by contacting TRENDnet within the applicable warranty period and providing a copy of the dated proof of the purchase. Upon proper submission of required documentation a Return Material Authorization (RMA) number will be issued. An RMA number is required in order to initiate warranty service support for all TRENDnet products. Products that are sent to TRENDnet for RMA service must have the RMA number marked on the outside of return packages and sent to TRENDnet prepaid, insured and packaged appropriately for safe shipment. Customers shipping from outside of the USA and Canada are responsible for return shipping fees. Customers shipping from outside of the USA are responsible for custom charges, including but not limited to, duty, tax, and other fees.

**WARRANTIES EXCLUSIVE:** IF THE TRENDNET PRODUCT DOES NOT OPERATE AS WARRANTED ABOVE, THE CUSTOMER'S SOLE REMEDY SHALL BE, AT TRENDNET'S OPTION, REPAIR OR REPLACE. THE FOREGOING WARRANTIES AND REMEDIES ARE EXCLUSIVE AND ARE IN LIEU OF ALL OTHER WARRANTIES, EXPRESSED OR IMPLIED,

EITHER IN FACT OR BY OPERATION OF LAW, STATUTORY OR OTHERWISE, INCLUDING WARRANTIES OF MERCHANTABILITY AND FITNESS FOR A PARTICULAR PURPOSE. TRENDNET NEITHER ASSUMES NOR AUTHORIZES ANY OTHER PERSON TO ASSUME FOR IT ANY OTHER LIABILITY IN CONNECTION WITH THE SALE, INSTALLATION MAINTENANCE OR USE OF TRENDNET'S PRODUCTS.

TRENDNET SHALL NOT BE LIABLE UNDER THIS WARRANTY IF ITS TESTING AND EXAMINATION DISCLOSE THAT THE ALLEGED DEFECT IN THE PRODUCT DOES NOT EXIST OR WAS CAUSED BY CUSTOMER'S OR ANY THIRD PERSON'S MISUSE, NEGLIGENCE, IMPROPER INSTALLATION OR TESTING, UNAUTHORIZED ATTEMPTS TO REPAIR OR MODIFY, OR ANY OTHER CAUSE BEYOND THE RANGE OF THE INTENDED USE, OR BY ACCIDENT, FIRE, LIGHTNING, OR OTHER HAZARD.

**LIMITATION OF LIABILITY:** TO THE FULL EXTENT ALLOWED BY LAW TRENDNET ALSO EXCLUDES FOR ITSELF AND ITS SUPPLIERS ANY LIABILITY, WHETHER BASED IN CONTRACT OR TORT (INCLUDING NEGLIGENCE), FOR INCIDENTAL, CONSEQUENTIAL, INDIRECT, SPECIAL, OR PUNITIVE DAMAGES OF ANY KIND, OR FOR LOSS OF REVENUE OR PROFITS, LOSS OF BUSINESS, LOSS OF INFORMATION OR DATE, OR OTHER FINANCIAL LOSS ARISING OUT OF OR IN CONNECTION WITH THE SALE, INSTALLATION, MAINTENANCE, USE, PERFORMANCE, FAILURE, OR INTERRUPTION OF THE POSSIBILITY OF SUCH DAMAGES, AND LIMITS ITS LIABILITY TO REPAIR, REPLACEMENT, OR REFUND OF THE PURCHASE PRICE PAID, AT TRENDNET'S OPTION. THIS DISCLAIMER OF LIABILITY FOR DAMAGES WILL NOT BE AFFECTED IF ANY REMEDY PROVIDED HEREIN SHALL FAIL OF ITS ESSENTIAL PURPOSE.

**Governing Law:** This Limited Warranty shall be governed by the laws of the state of California.

Some TRENDnet products include software code written by third party developers. These codes are subject to the GNU General Public License ("GPL") or GNU Lesser General Public License ("LGPL").

Go to <http://www.trendnet.com/gpl> or <http://www.trendnet.com> Download section and look for the desired TRENDnet product to access to the GPL Code or LGPL Code. These codes are distributed WITHOUT WARRANTY and are subject to the copyrights of the developers. TRENDnet does not provide technical support for these codes. Please go to <http://www.gnu.org/licenses/gpl.txt> or <http://www.gnu.org/licenses/lgpl.txt> for specific terms of each license.

V1.0R/ 01.17.2014



## Product Warranty Registration

Please take a moment to register your product online.  
Go to TRENDnet's website at <http://www.trendnet.com/register>

TRENDnet  
20675 Manhattan Place  
Torrance, CA 90501. USA