

User's Guide

**TRENDNET<sup>®</sup>**



**Indoor/Outdoor 4MP Motorized Varifocal  
PoE IR Dome Network Camera**

**TV-IP345PI**

## Contents

- Product Overview..... 1**
  - Package Contents .....1
  - Features.....1
  - Product Hardware Features .....2
- Installation ..... 3**
  - Hardware Installation.....3
  - Camera Installation .....5
- Configuration ..... 7**
  - Viewing Camera Basic Function .....7
  - Configuring the Camera Setting .....9
  - SYSTEM.....10
  - NETWORK.....12
  - AUDIO/VIDEO SETTING .....23
  - EVENT CONFIGURATION .....28
  - LOGOUT.....34
- Accessing the camera with Chrome ..... 34**
- Troubleshooting ..... 35**

## Product Overview



**TV-IP345PI**

### Package Contents

- TV-IP345PI
- Quick Installation Guide
- CD-ROM (Utility, Software & User's guide)
- Network cable (1.5 M/ 5 ft.)
- RJ-45 coupler
- Camera Mounting hardware

### Features

TRENDnet's Indoor / Outdoor 4 Varifocal MP PoE IR Dome Network Camera, model TV-IP345PI, provides powerful 4 MP HD night vision at 30 fps in complete darkness for up to 20m (66 ft.). This IP66 weather rated camera features manual pan/tilt and auto-focus / optical zoom which provide installation flexibility and time savings. Use the included pro-grade software to manage up to 32 TRENDnet cameras or download the free iOS® or Android™ mobile app.

#### **4 Megapixel**

Record 2688 x 1520 pixel resolution at a 30 fps in the space saving H.264 compression format

#### **Auto-Focus / Optical Zoom**

Auto-focus saves installation and troubleshooting time and remote optical zoom allows users to capture the precise desired viewing field

#### **Night Vision**

Night vision up to 30m (100ft.) in complete darkness

#### **PoE**

Save installation costs with Power over Ethernet (PoE)

#### **Outdoor Ready**

Outdoor IP66 weather rated with an operating temperature range of -20 to 60 °C (-4 to 140 °F)

#### **GPIO Ports and Alerts**

Network an alarm system to Input / Output ports

#### **Audio Support**

Audio in and out ports for third party microphone and speaker (sold separately)

**Power Port**

Save installation costs with Power over Ethernet (IEEE 802.3af)

**Micro SD Card Slot**

Add up to 64 GB memory for on-board video storage

**D-WDR**

Digital Wide Dynamic Range improves video quality in high contrast lighting environments

**Motion Detection**

Create motion detection windows with separate sensitivity settings and event triggers

**IPv6 / ONVIF**

IPv6 supported and ONVIF compliant

**Varifocal**

Optical zoom by a factor of 4.2x with auto-focus to a final fixed position for installation flexibility

**Multi-Language Interface**

Support for English, French, Spanish, German, and Portuguese

**Complimentary App**

Live video to a mobile device with a free iOS® and Android™ apps

**Complimentary Software**

Complimentary pro-grade software to manage up to TRENDnet 32 cameras

**Product Hardware Features****Camera Overview**

- **Housing:** IP66 and IK10 rating housing.
- **IR Lens:** IR lens for the camera.
- **Camera Base:** the mounting stand to hold the camera.

## Camera Connectors

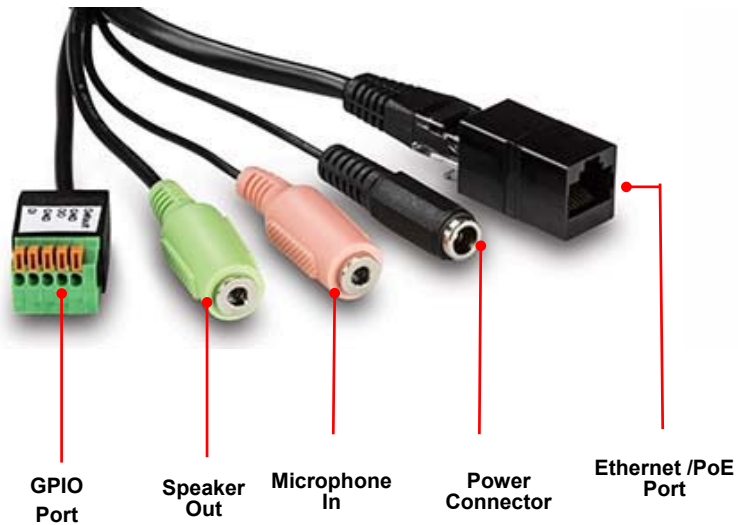

- **Power Connector:** Connects the power adapter to supply power to the camera if using non-PoE connection
- **Microphone In:** Connects an external microphone to receive the on-the-spot sound where the camera is installed.
- **Ethernet/PoE Port:** Plugs the network cable to connect to your local area network (LAN). If you are using the PoE, you must have the network cable connect to your PoE switch or PoE Injector.
- **GPIO Port:** Connect external device. Please refer to I/O setting paragraph. It's also used for IP camera reset. Please refer to Factory Default paragraph.
- **Speaker Out:** Connects an external audio device (such as the active speaker) to deliver sound via the camera.

## Installation

### Hardware Installation

#### Viewing Angle

Choose the location where has good angle to shoot the image you expect to see. The motion detection area should also be considered when installing the camera.

#### Manual Pan/Tilt

The camera can manual pan/tilt to your desired location.

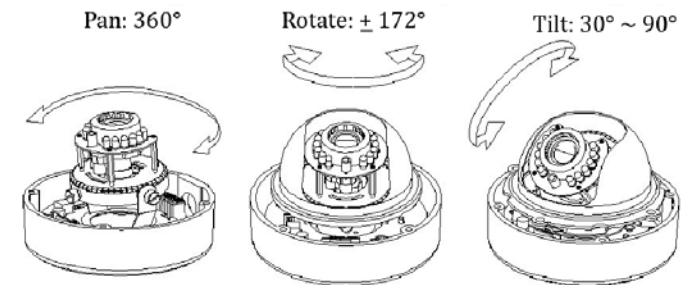

#### Waterproofing

The camera is designed to be waterproof. However, you need to protect the connectors from water damage. For example, you can tape the junction points of the connectors while you connect the cables or purchase a weatherproof cable/power cord protector.

### Vandal Dome Installation Tips

In order to ensure IP66 waterproof level, please install the vandal dome according to the instructions.

- The unused cable outlet hole must be closed and the waterproof connector on the used hole must be firmly locked.
- We recommend the bottom of housing be set and firmly sealed on a smooth flat surface.
- When mounting the camera housing on a ceiling or wall, please use the screws with the black rubber o-rings. Without the o-ring, water may seep into the machine.

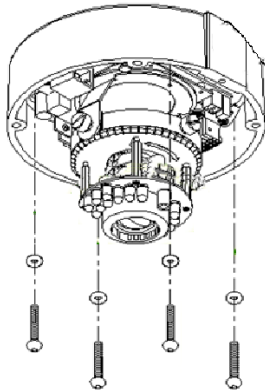

- Turn and loosen the control stick, shift right and left to adjust the vari-focal lens until the image becomes clear, then turn and tighten the stick to fix it.
- Before closing the dome cover, make sure that the black rubber band sticks to the inside of the cover completely. If the rubber band is crooked or uneven, it may cause the camera to no longer be waterproof.
- Lock the screws on the dome cover tightly to ensure there's no gap between the lid and the base.

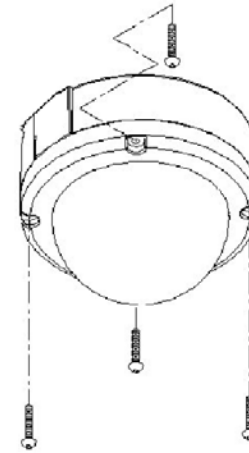

Note: When connecting cables into machine, it is recommended to use a hose to include all the cables inside instead of plugging in several cables separately. Water may seep through a gap from bundled cables. You can also seal the connector hole with silicone after installation.

## Camera Installation

1. Insert the Installation CD-ROM into your computer's CD-ROM drive to initiate the Auto-Run program. Click the Install Camera.



2. Write down the MAC ID of the camera

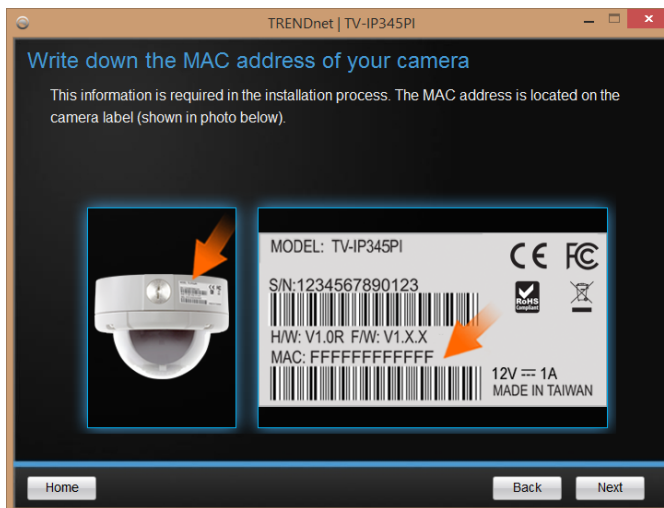

3. Plug in and connect the power adapter to the camera. If you are using the PoE to supply power to the camera, please skip to the next step. Click **Next** when you are done.

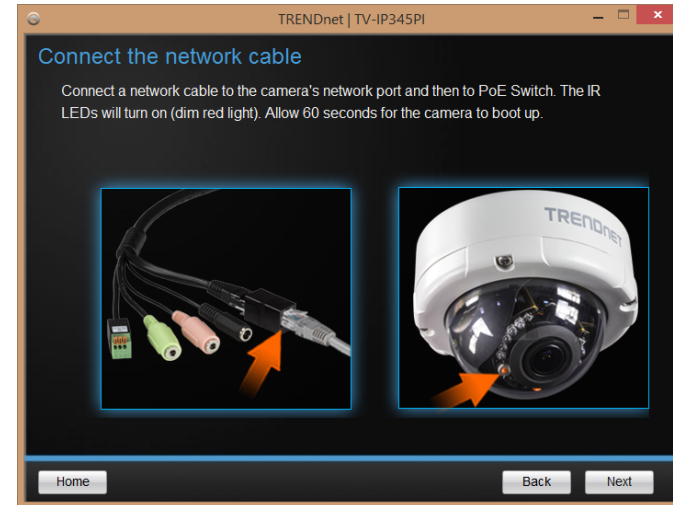

4. Wait while camera is searching.

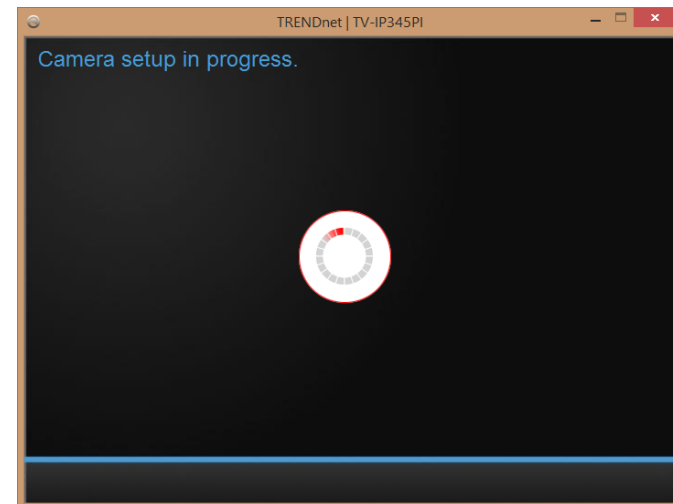

- 5. The founded cameras will show on the screen. The camera already selected by default if you have only one camera installed. If you have more than one camera in the same Network, you will need to identify the camera by the MAC ID. Click **Next**.

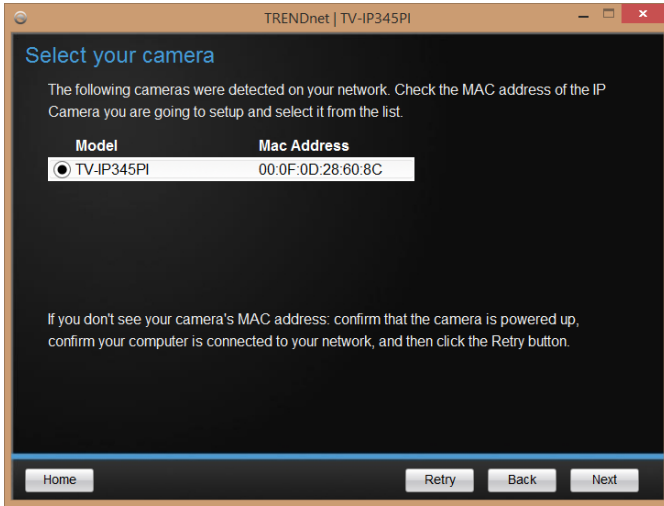

- 6. Select "DHCP" option to assign an IP by DHCP server or Select "Fixed IP" to set IP address manually. Click **Next**.

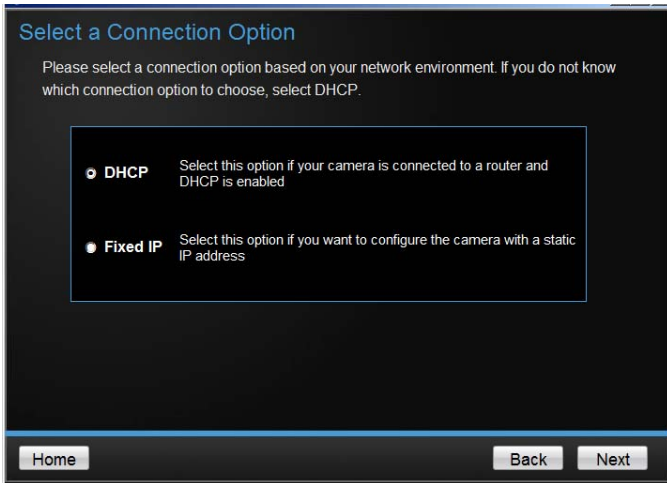

- 7. If you select "Fixed IP", fill out the IP address, subnet mask, default gateway, DNS server. Please ensure that the IP address of the camera and the computer must within the same network. Click **Next**.

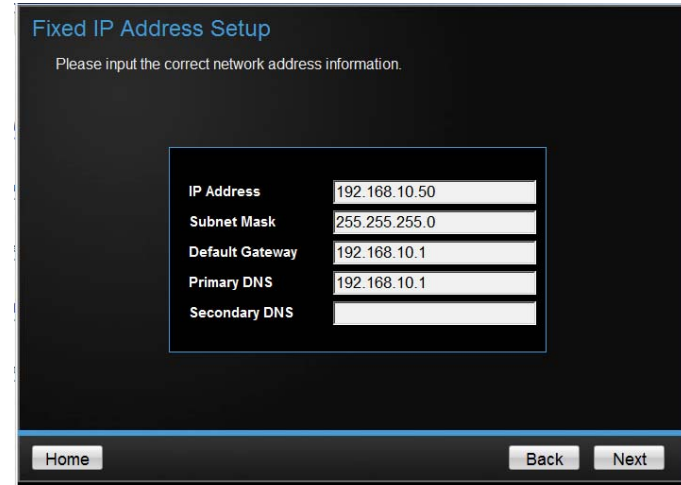

- 8. Type in the Password. The default password is "admin". You must change the default password of the camera. Enter the default password: admin and enter the new password. The password must be between 8 and 32 characters. (Alphanumeric: a-z, A-Z, 0-9), and entering the password two to confirm password.

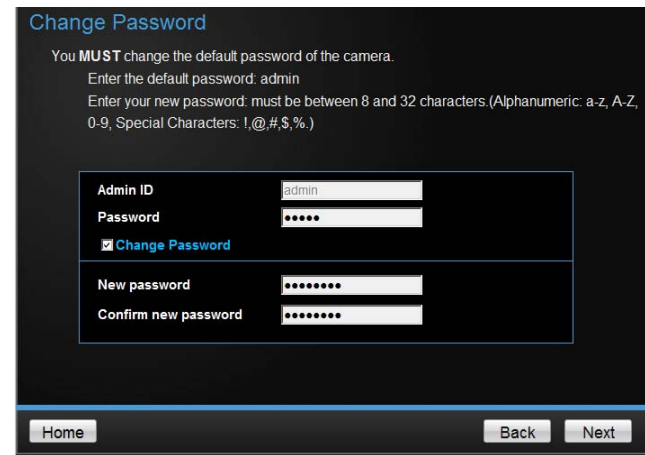



- Click the hyperlink **here** to access to the camera's web page or click **Next**. It is recommended that you access the IP camera now if it was using a DHCP connection.

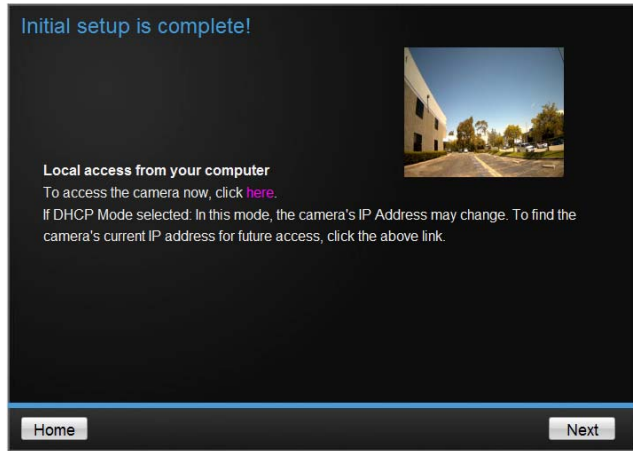

- Click **Finish** to exit the program or click **Home** to return to the main screen. This device also supports the Mobile App. Using your mobile device to scan the QR code to install the App.

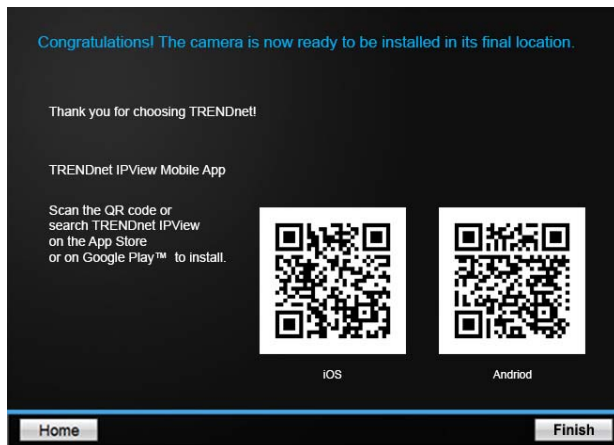

## Configuration

### Viewing Camera Basic Function

Open the Web browser on your computer (example showed in this User's Guide is based on the Internet Explorer). In the Address bar, type the IP address you got from "Camera Installation" chapter or found by IP Installer, and then press [Enter].

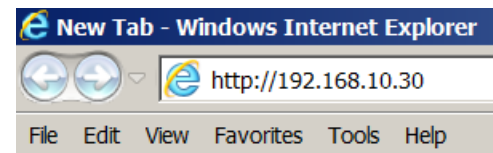

When the login window appears, enter the User name (admin) and Password and press OK to access to the main screen of the camera's Web Configuration.

Login to the TV-IP345PI	
User Name:	<input type="text" value="admin"/>
Password:	<input type="password" value="....."/>
Language:	<input type="text" value="English"/>
<input type="button" value="Login"/>	

After you login into the live screen of the camera, the main page will appear as below:

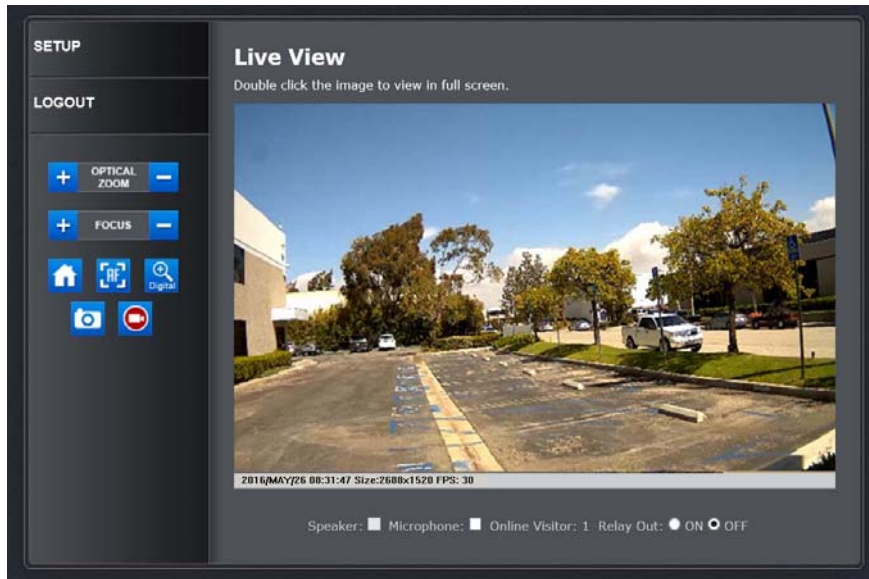

The live screen of the IP camera configuration provides you with many useful information and functions, including:

**SETUP:** Click the button to configure the camera.

**LOGOUT:** Click the button to log out of the camera viewing and configuration page.

**Digital Zoom:** Click on the + or – or the digital button to zoom in and out, or right click on the live view and select zoom to configure from 100% to 400% zoom size.

**FOCUS:** Click on + or – button or **AF** button to adjust the focus of the camera.

**Home button:** resume the camera back to default viewing settings.

**Snapshot button:** Click on snap shot button to save the current image to a destination folder.

**Recording button:** Click on recording button to save the current image to a destination folder.

**Speaker/Microphone:** Click the "Mic" to speak out through the camera. Click the "Speaker" to receive the on-side sound and voice from the camera.

**Online Visitor:** It shows how many people connect to this IP camera.

**Relay On:** Click the Relay out "ON" to trigger the relay output for testing. click "Off" to stop triggering. To switch between these two types of relay out, please refer to **Event Configuration >> GPIO Setting** session for detail.

One the live view video, right click the mouse for the additional menu options.



- **Snapshot:** Save a JPEG picture
- **Record Start:** Record the video in the local PC. It will ask you where to save the video. To stop recording, right-click the mouse again. Select "Record Stop". The video format is AVI. Use Microsoft Media Player to play the recorded file.
- **Mute:** Turn off the audio. Click again to turn on it.  
The "mute" button does not affect the playback recording video. As long as the "2-Way Audio" option in the audio setting is enabled, all the audio will be recorded into the playback video even you click "mute" in the live page.
- **Full Screen:** Full-screen mode.
- **Zoom:** Enable zoom-in and zoom-out functions. Select "Enable digital zoom" option first within the pop-up dialogue box and then drag and drop the bar to adjust the zoom factors.

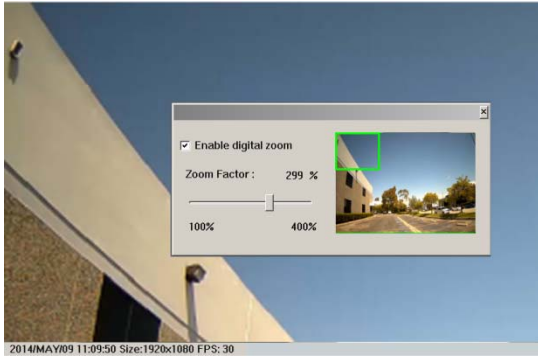

- **Frame Buffer mSec:** This function is to build a temporary buffer to accumulate several video frames. This function can make video smooth-going when the Network speed is slow and lag.

## Configuring the Camera Setting

To configure the camera, click **SETUP** on the live screen.

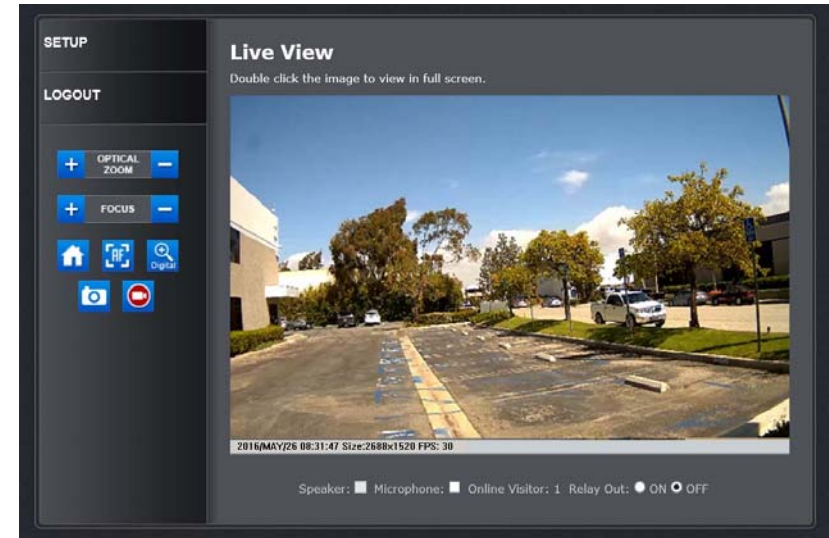

The Web Configuration contains the settings that are required for the camera in the left menu bar, including System, Network, Audio/Video Setting, Event Configuration and Logout.

To return to the live screen, please click the **LIVE VIEW** button.

**SYSTEM**

LIVE VIEW	<b>System Information</b>
SYSTEM	
NETWORK	<b>Server Information</b>
AUDIO / VIDEO SETTING	MAC Address: 00:0F:0D:28:80:8C
EVENT CONFIGURATION	Server Name: TV-IP345PI <input type="checkbox"/> Status Bar
LOGOUT	LED Indicator: <input type="radio"/> ON <input checked="" type="radio"/> OFF
	Language: <input type="radio"/> English <input checked="" type="radio"/> Français <input type="radio"/> Deutsch <input type="radio"/> España <input type="radio"/> Россия
	<b>OSD Setting</b>
	Time Stamp: <input checked="" type="radio"/> Enabled <input type="radio"/> Disabled
	Text: <input checked="" type="radio"/> Enabled <input type="radio"/> Disabled OSD_Display Text Edit
	<b>Time Setting</b>
	Server Time: 1969/12/31 17:04:47
	Date Format: <input type="radio"/> yyyy/mm/dd <input checked="" type="radio"/> mm/dd/yyyy <input type="radio"/> dd/mm/yyyy
	Time Zone: GMT-08:00 Pacific Time (US & Canada)
	<input checked="" type="checkbox"/> Enable Daylight Saving:
	<input type="radio"/> NTP
	NTP Server: time.trendnet.com
	Update: 8 Hour
	Time Shift: 0 Minutes[-1440..1440]
	<input checked="" type="radio"/> Synchronize with PC's time
	Date: 2018/05/27
	Time: 15:08:31
	<input type="radio"/> Manual
	Date: 2018/05/27
	Time: 15:08:28
	<input type="button" value="Apply"/>

**System >> System Information >> Server Information**

- **MAC Address:** It indicates the IP Camera's MAC address.
- **Server Name:** The Camera name.
- **LED Indicator:** Turn the LED light on or off by click the ON/OFF button.
- **Language:** There are 5 languages options. When changing the language, it will prompt dialogue box for confirmation. Click "Yes" to proceed.

**System >> System Information >> OSD Setting**

- **Time Stamp:** Enable or disable the time that will show on the live screen.
  - **Position:** After enabling time stamp, you can select the position of time stamp on the live screen.
- **Text:** Enable the Text option to have the desire text show on the camera live screen.
  - **Text Edit:** Click it to call out "text edit" window:
    - **Text:** Key in the words you want to show on the live screen.
    - **Opaque:** Set the background transparency of the text.



## System &gt;&gt; System Information &gt;&gt; Time Setting

- **Server Time:** It shows current IP camera server time.
- **Date Format:** Select the date display format.
- **Time Zone:** Select your time zone. It affect server time when you use "NTP" time.
- **Enable Daylight Saving:** select the start and end daylight saving time.
- **NTP:** Type in the IP address of the NTP server and interval time. The time of the IP camera will be synchronized with NTP server time. To use this option, if the NTP Server is under WAN, the IP camera must be set to access WAN ( Using the WAN IP that provide by your ISP provider, or setup by **UPnP Port Forwarding** (page 18)
- **Synchronize with PC's time:** In "Date" and "Time" column it shows your current PC time. Click "Apply" to make the IP camera time the same with PC time. Note that IP camera will not check with PC at every moment automatically. Every time when you want to synchronize the IP camera time with PC time again, please select this option and click "Apply".
- **Manual:** Type in the date and time, and click "Apply".

## System &gt;&gt; User Management

**User Management**

**Direct Video Stream Authentication**

Password Protection  YES  NO

Setting

**Add User**

Username:

Password:

Confirm:

Add/Set

**User List**

Username	User Group	Modify	Remove
admin	Administrator	<a href="#">Edit</a>	-----
1	Guest	<a href="#">Edit</a>	<a href="#">Remove</a>

- **Direct Video Stream Authentication:**

To stream the video directly without going through the configuration page, you can access it via Internet.

Stream 1 Video: [http://camera\\_ip\\_address:port/stream1view.htm](http://camera_ip_address:port/stream1view.htm)

Stream 1 Video: [http://camera\\_ip\\_address:port/stream2view.htm](http://camera_ip_address:port/stream2view.htm)

- **Enable Password Protection:**
  - **Yes:** User needs to enter user name and password to stream the camera.
  - **No:** User can stream the camera without entering the username and password.
  -
- **Add user:** Enter the username and password to add guest users to access the camera. The guest user can only view the live view video and is not allowed to do any configuration.
- **User List:** List all users that were added into the camera. Click "**Edit**" to modify the user information. Click "**Remove**" to remove the users from the list.

## System &gt;&gt; Tools

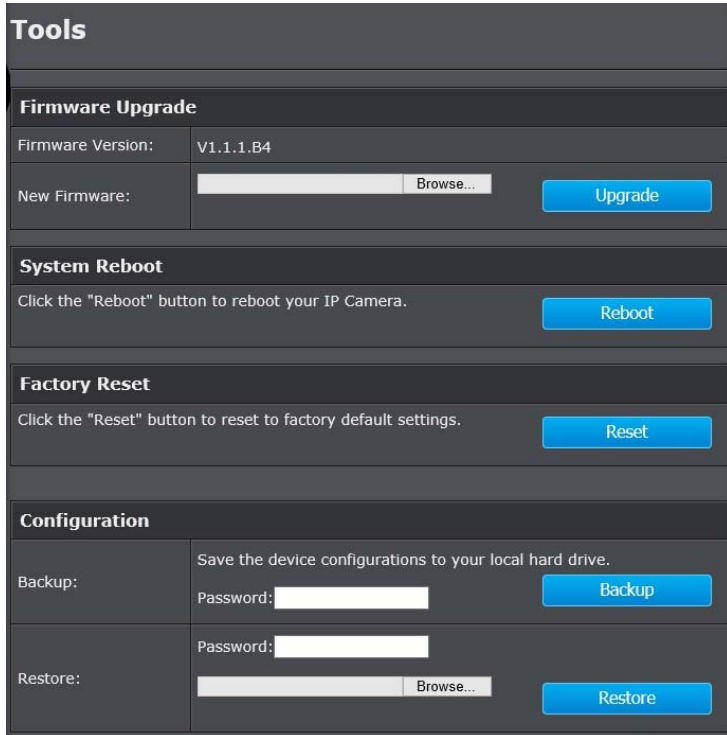

**Tools**

**Firmware Upgrade**

Firmware Version: V1.1.1.B4

New Firmware:  Browse...

**System Reboot**

Click the "Reboot" button to reboot your IP Camera.

**Factory Reset**

Click the "Reset" button to reset to factory default settings.

**Configuration**

Backup: Save the device configurations to your local hard drive.  
Password:

Restore:  Browse...

- **Firmware Upgrade:**  
To update the firmware, click "**Browse**" to select the firmware, then click "**Upgrade**" to proceed. Please do not disconnect power or Network cable during firmware upgrading.
- **System Reboot:** Click **Reboot** to reboot the IP camera.
- **Factory Reset:** Click **Reset** to reset all the settings back to factory default value
- **Configuration:**
  - **Backup:** Click **Backup** to save the configuration to your computer.
  - **Restore:** Click "**Browse...**" to select the configure file from your computer then click **Restore** to restore all setting

## NETWORK

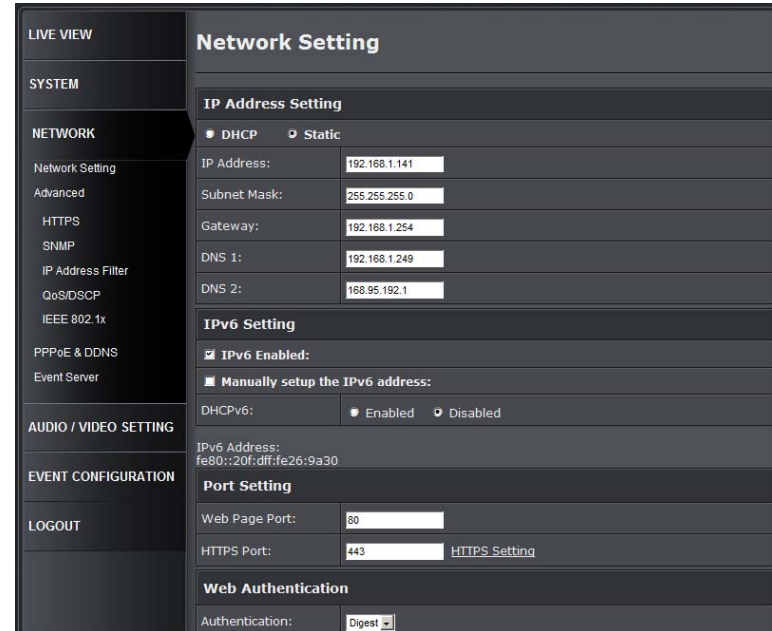

**Network Setting**

**IP Address Setting**

DHCP  Static

IP Address:

Subnet Mask:

Gateway:

DNS 1:

DNS 2:

**IPv6 Setting**

IPv6 Enabled:

Manually setup the IPv6 address:

DHCPv6:  Enabled  Disabled

IPv6 Address: fe80::20f:dff:fe26:9a30

**Port Setting**

Web Page Port:

HTTPS Port:  [HTTPS Setting](#)

**Web Authentication**

Authentication:

## Network &gt;&gt; Network Setting &gt;&gt; IP Address Setting

- **DHCP:** Select this option when your network uses the DHCP server. When the camera starts up, it will be assigned an IP address from the DHCP server automatically.
- **Static IP:** Select this option to type in IP address, subnet mask, gateway, and DNS manually. Default IP address is 192.168.10.30 if the camera doesn't connect with DHCP server. DNS (Domain Name System) translates domain names into IP addresses. Enter the Primary DNS and Secondary DNS that are provided by the ISP.

## Network &gt;&gt; Network Setting &gt;&gt; IPv6 Setting

IPv6 Setting	
<input checked="" type="checkbox"/> IPv6 Enabled:	
<input checked="" type="checkbox"/> Manually setup the IPv6 address:	
DHCPv6:	<input checked="" type="radio"/> Enabled <input type="radio"/> Disabled
IPv6 Address: fe80::20f:dff:fe26:68f6	

IPv6 is a newer numbering system that provides a much larger address pool than IPv4, which accounts for most of today's Internet traffic. You can manually enter IPv6 address, enable DHCPv6 to get IPv6 address automatically.

- **Manually setup the IPv6 address:** You can set up IPv6 manually by enter IP Address, Gateway, and DNS.
- **DHCPv6:** If you have a DHCPv6 server, enable this option to assign the IPv6 from server. The assigned IP address will be displayed
- **IPv6 Address:** A virtual IPv6 address generated by the IP camera. This virtual IPv6 address cannot use on WAN. To access the IP camera via IPv6 address, open a web browser and type in http:// [IPv6 Address] in the address bar. The [ ] parentheses mark is necessary for IPv6 address.

## Network &gt;&gt; Network Setting &gt;&gt; Port Setting

Port Setting	
Web Page Port:	80
HTTPS Port:	443 <a href="#">HTTPS Setting</a>

- **Web Page Port:** Setup HTTP web page connecting port which is also video transmitting port (Default: 80)
- **HTTPS Port:** Setup HTTPS connecting port (Default:443)

## Network &gt;&gt; Network Setting &gt;&gt; Web Authentication

Web Authentication	
Authentication:	Digest

The camera supports two levels of authentication, Basic and Digest. The Basic option having the username and password transmitted as plain text. The digest option encrypted username and password during data transmission. The default authentication is set to Digest.

## Network &gt;&gt; Network Setting &gt;&gt; UPnP

UPnP	
UPnP:	<input checked="" type="radio"/> Enabled <input type="radio"/> Disabled
UPnP Port Forwarding:	<input type="radio"/> Enabled <input checked="" type="radio"/> Disabled
External Web Port:	80 < The router doesn't support UPnP Port Forwarding.
External HTTPS Port:	443
External RTSP Port:	554 < The router doesn't support UPnP Port Forwarding.

- **UPnP:**

This IP camera supports UPnP (Universal Plug and Play) which is a set of computer network protocols that enable the device to device interoperability
- **UPnP Port Forwarding:**

When the camera is installed under a router, enable **UPnP Port Forwarding** to let the router open ports so that the video streams can be sent out from a LAN. Set Web Port, Https Port, and RTSP port, and make sure your router supports UPnP and the function has been activated.

After type in the port number and click "Apply", the port forwarding status will display beside the port column. There are three status will show.

  - Registered successfully: UPnP port forwarding setting succeeds.
  - The router doesn't support UPnP Port Forwarding: The camera can detect the router, but router return a message that it does not support UPnP Port Forwarding.

- The router is with some problems. Please reboot it: The camera cannot detect the router. Please check your router.

If this router has a WAN IP, this function allows the camera to do WAN access. In the address bar of browser, key in: "https:// (router WAN IP): (external web port) /" to access the IP camera.

**Network >> Network Setting >> RTSP Setting**

RTSP Setting	
RTSP Server:	<input type="radio"/> Enabled <input checked="" type="radio"/> Disabled
RTSP Authentication:	Digest
RTSP Port:	554
RTP Start Port:	5000 [1024..9997]
RTP End port:	9000 [1027..10000]

- RTSP Server:**  
 Enable it, then you can access camera and get image via RTSP protocol.  
 If you have a media player that supports RTSP protocol, you can use it to receive the video streaming from IP camera. The RTSP address can be set for two streamings respectively.
- RTSP Authentication:**  
 "Disable" means everyone who knows your camera IP Address can link to your camera via RTSP. No username and password are required.  
 Under "Basic" and "Digest" authentication mode, the camera asks the user to give username and password before allows accessing. The password is transmitted as plain text under basic mode, which provides a lower level of security than under digest mode. Make sure your media player supports the authentication schemes.
- RTSP Port:** It's used for TCP connection. Setup port for RTSP transmitting (Default: 554)
- RTSP Start and End Port:** It's used for UDP connection. Setup port for RTSP transmitting (Default: 5000, 9000)

**Network >> Network Setting >> Multicast Setting (Based on the RTSP Server)**

Multicast Setting (Based on the RTSP Server)	
Stream 1:	
IP Address:	234.5.6.78 [224.3.1.0 ~ 239.255.255.255]
Port:	6000 [1 ~ 65535]
TTL:	15 [1 ~ 255]
Stream 2:	
IP Address:	234.5.6.79 [224.3.1.0 ~ 239.255.255.255]
Port:	6001 [1 ~ 65535]
TTL:	15 [1 ~ 255]

Multicast is a bandwidth conservation technology. This function allows several users to share the same packet sent from IP camera. To use Multicast, appoint IP Address and port here. TTL means the life time of packet. The larger the value is, the more user can receive the packet.

To use Multicast, be sure to enable the function "Force Multicast RTP via RTSP" in your media player. Then key in the RTSP path of your camera: "rtsp://(IP address)/" to receive the multicast.

**Network >> Network Setting >> ONVIF**

ONVIF	
ONVIF:	<input type="radio"/> v2.4.2 <input checked="" type="radio"/> v1.01 <input type="radio"/> Disabled
Security:	<input type="radio"/> Enabled <input checked="" type="radio"/> Disabled
RTSP Keepalive:	<input type="radio"/> Enabled <input checked="" type="radio"/> Disabled

Under ONVIF connection, the video will be transmitted by RTSP. Be sure to enable the RTSP server in IP setting, or you're not able to receive the video via ONVIF.

- ONVIF:**  
 Choose your ONVIF version. The two devices that use ONVIF to communicate should be set to the same version.



- **Security:**

Select "Disable", then the username and password are not required when accessing the camera via ONVIF. Select "Enable", then username and password are necessary.

- **RTSP Keepalive:**

When the function is enabled, the camera checks once in a while if the user who links to the camera via ONVIF still keeps connecting. If the connection had been broken, the camera stops transmitting video to user.

#### Network >> Network Setting >> Bonjour

Bonjour	
Bonjour:	<input checked="" type="radio"/> Enabled <input type="radio"/> Disabled
Bonjour Name:	TV-IP344PI @00:0F:0D:28:7D:E0

This function enable Safari browser's bookmark to link to this IP camera. The Bonjour name is the name that display in the bookmark. Please note the Bonjour function on Safari browser does not support https protocol. If you selected "https" mode, you will see the camera appears on Safari's bookmarks but will not be able to access the camera.

#### Network >> Network Setting >> LLTD

LLTD (Link Layer Topology Discovery)	
LLTD:	<input type="radio"/> Enabled <input checked="" type="radio"/> Disabled

If your PC supports LLTD, enable this function then you can check the connection status, properties, and device position(like IP address) of this IP Camera in the network map. In Windows Vista or Windows 7, you can find LLTD through the path: Call out the Control Panel → Network and Internet → Network and Sharing Center → Click "See full map".

#### Network >> Advanced >> HTTPS

When the users access cameras via Https protocol, the transmitted information will be encrypted so that the security level is arisen.

You can select the connection type.

- **Http:** user can access the camera via Http path.
- **Https:** user can access the camera via Https path but cannot via Http path.
- **Http & Https:** Both the Http and Https path can be used to access the camera. When you change the setting of connection type, it may cause connection error or disconnection error if you switch the protocol directly. Therefore, Http & Https mode is necessary. If you want to change from Http to Https, please switch to "Http & Https" mode first, and then switch to "Https" mode. Same method when you change from Https to Http.

The Https protocol has certificate verifying mechanism. When the user access a website via Https, the browser will check the certificate of that domain and verify its trustiness and secure.

Certificate generation process:

1. **Remove the existing certificate:** Before you generate a new certificate, please remove existing one. Select "Http" connection type and click "Remove". If a dialog box pops up to ask you to confirm, click "Yes".

**HTTPS Setting**

**Created Request**

Subject: C=TW, ST=, L=, O=, OU=, CN=

Date: 2014/Mar/12 16:56:10

Content Remove

**Installed Certificate**

Subject: C=TW, ST=, L=, O=, OU=, CN=

Date: Mar 14 08:45:42 2038 GMT

Content Remove

**Connection Types**

HTTP

2. **Created Request:** Fill in the following form and click “apply”.

**Create Request**

Country:

State or province:

Locality:

Organization:

Organizational Unit:

Common Name:

Apply

3. After you generate a certificate request, if you choose to turn it to the trusted third-party to verify, please click “Content” and copy all the request content.

**Created Request**

Subject: C=TW, ST=, L=, O=

Date: 2014/Mar/26 18:35:17

Content Remove

**Certificate Request:**

**Data:**

Version: 0 (0x0)

Subject: C=TW

Subject Public Key Info:

Public Key Algorithm: rsaEncryption

Public-Key: (1024 bit)

Modulus:

```
00:d6:65:25:d9:30:02:65:76:72:07:b3:51:43:1d:
a5:c3:6c:87:d1:19:3c:8b:52:40:3e:4a:f2:9b:7e:
df:a5:25:8f:95:ed:2d:ca:96:50:96:d3:ee:12:ed:
e3:96:c6:20:9d:b6:0e:58:99:94:dc:47:08:ec:56:
44:6f:95:1b:93:e9:2d:eb:1e:02:f0:2c:85:1b:28:
```

- According to the certificate source, there are two ways to install the certificate.
  - If you had sent the certificate request to do sign and received a signed certificate, please click” browse” and find the certificate file in your computer. Click “Apply” to install it.
  - If you choose to generate a self-signed certificate, fill in the following forms and set validity day, click “Apply” to finish installed it.

**Create Self-Signed Certificate**

Country:

State or province:

Locality:

Organization:

Organizational Unit:

Common Name:

Validity:  Days

After finishing installation, you can click “Content” to call out and check the certificate content.

**Installed Certificate**

Subject: C=TW, ST=, L=, O=, OU=, CN=

Date: Apr 26 02:45:20 2014 GMT

Content Remove

- To use Https to access camera, open your browser, and key in "https://(IP address)/" in the address bar. Now your data will be transmitted via encrypted communications, and the browser will check your certificate status. If it shows you a warning message. The warning message meant that the certificate is self-signed or signed by distrusted institution. Click **Continue to this website** to view the view the camera.

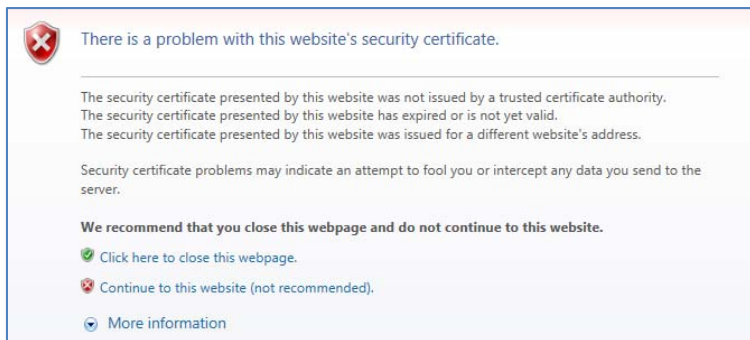

**Network >> Advanced >> SNMP**

SNMP (Simple Network Management Protocol) provides a simple framework for administering networked hardware. To manage the IP camera, you have to prepare a MIB browser or similar tools first. SNMPv1, SNMPv2c, and SNMPv3 can be enabled simultaneously.

The following examples are based on MG- SOFT MIB Browser. Depending on your MIS Browser, you may see different interface and options. Please refer to the user manual of your MIB Browser.

- SNMPv1 and SNMPv2c:



The term "Community name" in SNMPv1 and SNMPv2c can be roughly regarded as key. The person who has the community name has the authority to read or edit the information of IP camera via SNMP.

Click the box to enable SNMPv1 or SNMPv2c protocol, and specify the community name for write (read and write) and read (read-only). The user who use read community name to access the IP camera cannot modify any data of the camera. The community name can be any English characters and numbers, and must be shorter than 31 bits.

- SNMPv3:



For data security reason, the authentication and encryption assurances are added when developing SNMPv3. The user has to give not only the security name (similar with "community name" in v1&v2c) but the password in order to access the IP camera. Please set security name, authentication type, authentication password, encryption type, encryption password of write and read respectively. The security

name can be any English characters and numbers, and must be shorter than 31 letters. The password must be 8~64 letters in length.

Different from in SNMPv1 and v2c, the user have to create an account when using SNMPv3. In the account parameters, key in the security name and password you set in the camera to get accessing.

- SNMPv1/SNMPv2 Trap:

**SNMPv1/v2c Trap**

Trap Address:

Trap Community:

Trap Event:

- Cold Start
- Setting Changed
- Network Disconnected
- V3 Authentication Failed
- SD Insert/Remove

Trap is a mechanism that allows a managed device to send messages to the manager instead of waiting passively for polling from the manager. Specify the trap event. When those events occur, the camera will send the ring message to the Trap Address, which is usually the manager's IP address. Trap Community means the community that can receive the trap message.

Note: Trap Address must be under the same LAN with IP camera.

- **Cold Start:** The camera starts up or reboots.
- **Setting changed:** The SNMP setting is changed.
- **Network Disconnected:** The network connection was broken down. (The camera will send trap messages after the network being connected again)
- **V3 Authentication Failed:** A SNMPv3 user account tries to get authentication but failed. (Due to incorrect password or community)

Network >> Advanced >> IP Address Filter

**IP Address Filter Setting**

Enable ip address filter

IPv4 Setting:  Allow  Deny

single address:

---

**IPv4 List:**

No.	IP Address	Filter	Action
1			<input type="button" value="remove"/>
2			<input type="button" value="remove"/>

---

Always allow admin IP address access to this device

Admin IP address:

You can allow or deny an IP address or even a range of the IP address to access the IP camera. If you would like to deny a range of IP address but would allow an IP within that range can access the camera, please setup the allow IP address in the 1<sup>st</sup> priority and set the deny range of IP address as 2<sup>nd</sup> priority as example below.

IPv4 List:			
No.	IP Address	Filter	Action
1	192.168.1.23	allow	<input type="button" value="remove"/>
2	192.168.1.1-192.168.1.254	deny	<input type="button" value="remove"/>

## Network &gt;&gt; Advanced &gt;&gt; QoS/DSCP

QoS/DSCP Setting	
<input type="checkbox"/> Enable QoS/DSCP	
Live Stream:	<input type="text" value="0"/> (0~63)
Event / Alarm:	<input type="text" value="0"/> (0~63)
Management:	<input type="text" value="0"/> (0~63)

DSCP specifies a simple mechanism for classifying and managing network traffic and provide QoS on IP networks. DSCP is a 6-bit in the IP header for packet classification purpose.

The number 0~63 for Live Stream, Event / Alarm, and Management represent the ratio that the bandwidth is divided. For example, if you set 5, 10, and 20 for these three items, then the bandwidth of these items is 5:10:20. The item getting more bandwidth has lower probability to be delayed. There is no difference between setting "0, 0, 0" or "63, 63, 63" because under these two setting the three items will get equal bandwidth (1/3).

The three stream control the protocols respectively:

- **Live Stream** (Video and audio) : RTP / RTSP
- **Event/Alarm** : FTP / SMTP / SAMBA / SIP
- **Management** : HTTPS / HTTP / SNMP

Note: The "Management" stream handles both the live view and the setting area of the web page on which the data is transferred via http/https protocol. If you prefer to distribute more bandwidth when using the web browser to watch the live video, please adjust the Management Stream instead of Live Stream.

## Network &gt;&gt; Advanced &gt;&gt; IEEE 802.1x

IEEE 802.1x Setting	
<input type="checkbox"/> Enable IEEE 802.1x	
EAPOL version:	<input checked="" type="radio"/> v1 <input type="radio"/> v2
Identity:	<input type="text"/>
Private key password:	<input type="text"/>
<input type="button" value="Apply"/>	
CA certificate:	<input type="text"/> Browse... <input type="button" value="Upload"/>
Status:	<input type="text"/> <input type="button" value="Remove"/>
Client certificate:	<input type="text"/> Browse... <input type="button" value="Upload"/>
Status:	<input type="text"/> <input type="button" value="Remove"/>
Client private key:	<input type="text"/> Browse... <input type="button" value="Upload"/>
Status:	<input type="text"/> <input type="button" value="Remove"/>

IEEE 802.1x is an IEEE standard for port-based Network Access Control. It provides an authentication mechanism to device wishing to attach to a LAN or WLAN. To use this function, you need a device to build IEEE 802.1x LAN at first.

The EAPOL protocol support service identification and optional point to point encryption over the local LAN segment.

Please check what version of the authenticator and authentication server support. This camera supports EAP-TLS method. Please enter ID, password issued by the CA, then upload related certificates.

## Network &gt;&gt; PPPoE &amp; DDNS

PPPoE & DDNS	
<b>PPPoE Setting</b>	
Enable:	<input checked="" type="radio"/> Enabled <input type="radio"/> Disabled
Username:	<input type="text"/>
Password:	<input type="text"/>
Send mail after PPPoE dialed:	<input checked="" type="checkbox"/> Enabled
Subject:	PPPoE_TV-IP343PI
<b>DDNS Setting</b>	
Enable:	<input checked="" type="radio"/> Enabled <input type="radio"/> Disabled
Provider:	www.noip.com
Hostname:	<input type="text"/>
Username:	<input type="text"/>
Password:	<input type="text"/>
Schedule Update:	1440 <input type="text"/> Minutes
<b>State</b>	
Idle	
<b>Note:</b>	
<ol style="list-style-type: none"> <li>1. Update Schedule: DDNS will be updated automatically. The time range is from 60 to 5000 minutes. If you do not wish to obtain updates, enter "0".</li> <li>2. For dyn.com and 3322.org, it is recommended that updates are done once per day (1440 minutes). Your account may be blocked if frequent updates are detected.</li> </ol>	

## • PPPoE

PPPoE Setting	
Enable:	<input checked="" type="radio"/> Enabled <input type="radio"/> Disabled
Username:	<input type="text"/>
Password:	<input type="text"/>
Send mail after PPPoE dialed:	<input checked="" type="checkbox"/> Enabled
Subject:	PPPoE_TV-IP343PI

Select "Enabled" to use PPPoE. Type in the username and password for the ADSL connection.

Send mail after dialed: When successfully connecting to the internet, it sends a mail to a specific mail account. As for the mail account setting, please refer to Server setting page.

## • DDNS

DDNS Setting	
Enable:	<input checked="" type="radio"/> Enabled <input type="radio"/> Disabled
Provider:	www.noip.com
Hostname:	<input type="text"/>
Username:	<input type="text"/>
Password:	<input type="text"/>
Schedule Update:	1440 <input type="text"/> Minutes

This camera supports following Dynamic DNS server: Dyndns.com, 3322.org, no-ip.com and IPTECNO DDNS.

Enable DDNS, and select a DDNS provider. Some providers will ask you to register and get an account before you use their service. Fill in the user name, hostname, and password (if need). If setting up IP schedule update too frequently, the IP may be blocked. In general, we suggest set schedule update to once a day (1440 minutes). After click "Apply" the setting.

**DDNS Status:**

- Updating: Information update
- Idle: Stop service
- DDNS registration successful, can now log by http://<username>.no-cp.com: Register successfully.
- Update Failed, the name is already registered: The user name has already been used. Please change it.
- Update Failed, please check your internet connection: Network connection failed.
- Update Failed, please check the account information you provided: The server, user name, and password may be wrong.

**Network >> Event Server**

Event Server	
<b>Mail Setting</b>	
Login Method:	Account
Mail Server:	
Username:	
Password:	
Sender's Mail:	
Receiver's Mail:	
Bcc Mail:	
Mail Port:	25 (Default 25)
Secure Connection:	<input checked="" type="checkbox"/> Enable Secure Connection <input type="checkbox"/> TLS <input type="checkbox"/> SSL
<a href="#">Test</a>	
<b>FTP Setting</b>	
FTP Server:	
Username:	
Password:	
Port:	21
Path:	/
Mode:	PORT
Create the folder:	Yes (ex:Path/20100115/121032m.avi)
<a href="#">Test</a>	
<b>Samba (Network storage)</b>	
Location:	(ex:\\Nas_ip\folder)
Workgroup:	
Username:	
Password:	
Create the folder:	Yes (ex:Path/20100115/121032m.avi)
<a href="#">Test</a>	

The settings of Email, FTP and SAMBA are used when the event occurs, schedule snapshot executes, or the alarm input is triggered. Select the item to display the detailed configuration options. You can configure either one or all of them.

- **Mail Setting**

Mail Setting	
Login Method:	Account <input type="button" value="v"/>
Mail Server:	<input type="text"/>
Username:	<input type="text"/>
Password:	<input type="password"/>
Sender's Mail:	<input type="text"/>
Receiver's Mail:	<input type="text"/>
Bcc Mail:	<input type="text"/>
Mail Port:	25 <input type="text"/> (Default 25)
Secure Connection:	<input type="checkbox"/> Enable Secure Connection <input checked="" type="radio"/> TLS <input type="radio"/> SSL
<input type="button" value="Test"/>	

- **Login Method:** Select "Anonymous" to disable the authentication feature, or select "Account" and then enter the Username and Password according to the mail server configuration.
- **Mail Server:** Enter the mail server address. For example, myserver.com. If you are using a free mail service (e.g. Google gmail.com®, Yahoo®, Hotmail®), please enter the SMTP server address from the service provider.
- **Username & Password:** Enter the sender's username and password to login the mail server. For free mail server, please the email address as the username.
- **Sender's Mail:** Enter the email address of the user who will send the email.
- **Receiver's Mail:** Enter the mail address of the user who will receive the email. Use semicolon to separate each address. It can contain up to 64 characters in the column.
- **Bcc Mail:** Enter the mail address of the blind carbon copy receiver.
- **Mail Port:** Assign the SMTP port in the text box. The default SMTP port is 25. For the free mail service, please enter the correct port number from the service provider.

- **Secure Connection:** If the mail server requires an encrypted connection, you should select the SSL option. TTLS is an extension to plain text communication protocols. It offers a way to upgrade a plain text connection to an encrypted (TLS or SSL) connection.

Click **Apply** to save the setting, then use **Test** button to test the server connection. A message box will tell you "OK!" if it works, and a test e-mail will be sent to receiver's mail address.

- **FTP Setting:**

FTP Setting	
FTP Server:	<input type="text"/>
Username:	<input type="text"/>
Password:	<input type="password"/>
Port:	21 <input type="text"/>
Path:	/ <input type="text"/>
Mode:	PORT <input type="button" value="v"/>
Create the folder:	Yes <input type="button" value="v"/> (ex:Path/20100115/121032m.avi)
<input type="button" value="Test"/>	

- **FTP Server:** Enter the IP address of the target FTP server.
- **Username & Password:** Enter the username and password to login into the FTP server.
- **Port:** Enter the port number used for the FTP server.
- **Path:** Enter the destination folder for uploading the images. For example, /343PI.
- **Mode:** In **PORT** mode, the FTP server builds the connection to the user's data port actively. However, from the user-side firewall's standpoint, the action of connecting from FTP server is often considered to be dangerous and should be blocked. In **PASV** mode, the problem is solved: The FTP server waits for the data transmission connection built by the user. Make sure that the server supports the mode you select.
- **Create the folder:** Select Yes, then folders will be created folder by date under your FTP path.



Click **Apply** to save the settings, then click **Test** button to test the server connection. A message box will tell you "OK!" if it works, and a test file will be uploaded to FTP server.

- **Samba Setting:**

Samba (Network storage)	
Location:	<input type="text"/> (ex: \\Nas_ip\folder)
Workgroup:	<input type="text"/>
Username:	<input type="text"/>
Password:	<input type="text"/>
Create the folder:	<input type="checkbox"/> Yes <input type="checkbox"/> No (ex: Path/20100115/121032m.avi) <input type="button" value="Test"/>

- **Location:** Enter the path of the shared folder.
- **Workgroup:** Type in the workgroup name of the computer.
- **Username & Password:** Enter the username and password to login into the Samba.
- **Create the folder:** Select **Yes**, then folders will be created by date under your Samba Server.

Click **Apply** to save the setting, then use **Test** button to test the server connection. A message box will tell you "OK!" if it works, and a test file will be created in the location.

## AUDIO/VIDEO SETTING

Audio/Video Setting >> Image Setting

**Privacy Mask**

Area 1
Area 2
Area 3
Save

---

**Image Setting**

Brightness:

Contrast:

Hue:

Sharpness:

D-WDR:

Denoise 2D:

Shutter Time:

Sense-Up:

Saturation:

AGC:

Video Orientation:  Flip  Mirror  Rotate 90°

IR Intensity:

Day & Night:

Night to Day Lux:  (about)    Day to Night Lux:  (about)

Current Lux:  (about)

Day/Night Auto Focus:  ON  OFF

- Privacy Mask:** For the security and privacy purpose, there are three areas can be setup for privacy mask. Click Area button first and drag an area on the above image, and remember to save your setting. The masked area will not show on both the live view and recording.



- Brightness, Contrast, Hue, Saturation, Sharpness** can be adjusted here.
- AGC:** Automatic gain control. The sensitivity of camera can be adjusted with the environmental light. Enable this function and the brighter image can be got under dim light, but the level of noise may also increase.
- Shutter Time:** Choose as the location of your camera or fixed shutter time. The shorter the shutter time is, the less light the camera receives and the image becomes darker.

Note: When you select a number in "Shutter Time", actually the shutter time varies in a range and controlled by camera automatically. Following table shows the shutter time option and corresponding range.

Option	Shutter Time Range (sec.)
Outdoor	1/10000 ~ Selected number in "Sense-up"
Indoor	NTSC: 1/125 ~ Selected number in "Sense-up" PAL: 1/100 ~ Selected number in "Sense-up"
1/30	1/10000 ~ 1/30
1/50	1/10000 ~ 1/50
1/60	1/10000 ~ 1/60
1/100	1/10000 ~ 1/100
1/125	1/10000 ~ 1/125
1/250	1/10000 ~ 1/250
1/500	1/10000 ~ 1/500
1/1000	1/10000 ~ 1/1000
* Sense-up options: 1/30, 1/15, 1/10, 1/5	

- Sense-Up:** This function increases the sensitivity of camera to get brighter image at night. The smaller the value you select, the slower the shutter speed becomes so that the image will get brighter, and moving subjects might be blurred.  
Sense-Up option is only enabled when users select "outdoor" or "indoor" in shutter time option.
- D-WDR:** Digital Wide dynamic range. This function enables the camera to reduce the contrast in the view to avoid the dark zones resulting from over and under exposure.
- Video Orientation:** Flip, mirror, or rotate the image.
- Day & Night:** The camera can detect the light level of environment. If you choose "Light Sensor Mode", the image will be turned to black and white at night in order to keep clear. To set light sensor mode, appoint a lux standard of switching D/N here. Current lux value is provided for reference. Under "Times Mode" the switch time of Color / Black and white is according to the given time. If you select "Synchronize with DI input", the image turns to black and white when digital input is triggered. You can also control it by choosing "Color" or "B/W".

#### Audio/Video Setting >> Video Setting

The screenshot shows the 'Video' configuration page with the following settings:

- Video Settings:**
  - Input Resolution: 2688x1520 @ 30fps
  - Video System: NTSC
- Stream 1 Setting:**
  - Mode:  Basic Mode,  Advanced Mode
  - Resolution: 2688x1520
  - Profile: Main
  - Quality: Best
  - Video Frame Rate: 30 FPS
  - Video Format: H.264
  - RTSP Path: [ ] ex:rtsp://IP\_Address/ Audio:G.711
- Stream 2 Setting:**
  - Mode:  Basic Mode,  Advanced Mode,  Close
- 3GPP Streaming Setting:**
  - Mode:  Open,  Close

An 'Apply' button is located at the bottom of the page.

- Video Settings**  
Select Input Resolution and corresponding Video System (digital signal).

- **Basic Mode of Streaming 1 or Streaming 2:**

The screenshot shows the 'Video' settings page. It is divided into three main sections: 'Video Settings', 'Stream 1 Setting', and 'Stream 2 Setting'.  
**Video Settings:** Input Resolution is set to '2688x1520 @ 30fps' and Video System is 'NTSC'.  
**Stream 1 Setting:** Radio buttons for 'Basic Mode' and 'Advanced Mode' are present. Under 'Advanced Mode', Resolution is '2688x1520', Profile is 'Main', Quality is 'Best', Video Frame Rate is '30 FPS', and Video Format is 'H.264'. The RTSP Path is shown as 'ex:rtsp://IP\_Address/ Audio:G.711'.  
**Stream 2 Setting:** Radio buttons for 'Basic Mode', 'Advanced Mode', and 'Close' are present. Under 'Advanced Mode', Resolution is '640x360', Profile is 'Baseline', Quality is 'Medium', Video Frame Rate is '15 FPS', and Video Format is 'H.264'. The RTSP Path is shown as 'v2 ex:rtsp://IP\_Address/v2 Audio:G.711'.  
 At the bottom, there is a '3GPP Streaming Setting' section with 'Open' and 'Close' radio buttons, and an 'Apply' button.

- **Resolution:** 2688x1520, 1920x1080, 1280x720 , 640x480, 640x360, or 320x240
- **Quality:** The higher the quality is, the bigger the file size is. It might affect Internet transmitting speed if the file gets too large.
- **Video Frame Rate:** The video refreshing rate per second. The max value is affected by the input resolution you choose.
- **Video Format:** H.264 or M-JPEG.

- **RTSP Path:** Set the RTSP output connecting route. You can use the RTSP address displaying beside the column to access this IP camera.

- **Advanced Mode of Streaming 1 or Streaming 2:**

The screenshot shows the 'Stream 1 Setting' page in 'Advanced Mode'. It includes the following fields:  
 - Resolution: 2688x1520  
 - Profile: Main  
 - Bitrate Control Mode: CBR (selected) or VBR  
 - Video Quantitative: 9  
 - Video Bitrate: 4Mbps  
 - Video Frame Rate: 30 FPS  
 - GOP Size: 1 X FPS, with a note 'GOP = 30'  
 - Video Format: H.264  
 - RTSP Path: ex:rtsp://IP\_Address/ Audio:G.711

- **Resolution:** 2688x1520, 1920x1080, 1280x720 , 640x480, 640x360, or 320x240
- **Bitrate Control Mode:** In CBR(Constant Bit Rate) mode, the bitrate keeps consistent all over the video. In VBR(Variable Bit Rate) mode, the bitrate changes with the complexity extent of the video data. VBR provides a better compression way and the file may be smaller. However, the VBR file size cannot be predicted. The image may become broken or lagged when your bandwidth is not enough for the data quantity you selected.
- **Video Quantitative:** The quality parameter of VBR. You can choose 1~10 compression rate. The higher the value is, the higher the image quality is.
- **Video Bitrate:** The quality parameter of CBR. You can choose 32kbps ~8Mbps. The higher the value is, the higher the image quality is.
- **Video Frame Rate:** The video refreshing rate per second. The max value is affected by the input resolution you choose.
- **GOP Size:** It means "Group of Pictures". The higher the GOP is, the better the quality is.

- **Video Format:** H.264 or M-JPEG
- **RTSP Path:** RTSP output connecting route. You can use the RTSP address displaying beside the column to access this IP camera.

- **3GPP Streaming mode:**

3GPP Streaming Setting	
<input type="radio"/> Open <input checked="" type="radio"/> Close	
Resolution:	640x480 ▼
Video Bitrate:	256Kbps ▼
Video Frame Rate:	15 FPS ▼
RTSP Path:	v3 <input type="text"/> ex:rtsp://IP_Address/v3 Audio:AMR

3GPP Streaming is designed for specific mobile viewing. To receive video via 3gpp, please remember to enable rtsp server in the "Network Setting" page.

- **Resolution:** 640x480, 640x360, or 320x240
- **Video Bitrate:** You can choose 32kbps ~1Mbps. The higher the value is, the higher the image quality is.
- **Video Frame Rate:** The video refreshing rate per second. The max value is affected by the input resolution you choose.
- **RTSP Path:** 3GPP output connecting route. If the IP address of your camera is 192.168.1.160 and you type in "3g" in the column, the 3GPP path will be **rtsp://192.168.1.160/3g**.

### Audio/Video Setting >> Audio

IP Camera supports 2-way audio. Audio can be received by the microphone connected with IP camera and transmitted to remote PC. User can also send audio from remote computer's microphone to IP Camera's external speaker.

- **Two-Way Audio**

Select "Enable", then you can see "Mic" and "Speaker" options on the live page. The Audio compression format can be chosen from 3 options. You can also adjust the volume of 2-way audio.

Two-Way Audio	
Enable:	<input type="radio"/> Enabled <input checked="" type="radio"/> Disabled
Audio Type:	G.711 (64Kbps) ▼
Adjust Volume	
Mic-In:	0 ▼
Line-Out:	0 ▼

- **Receive sound from IP Camera or speak to IP Camera**

Click "Mic" check box to receive sound from IP Camera and click "Speaker" to talk to IP camera side. Please ensure both IP camera and the computer sides have the microphone and speaker installed to have this function work properly.

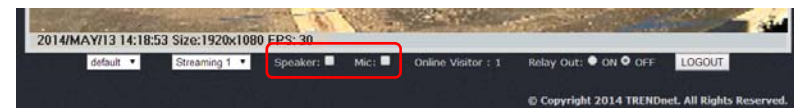

## EVENT CONFIGURATION

### Motion Detection

**Motion Detection**



Area Setting: Area 1 Area 2 Area 3

Sensitivity: 5 5 5

Area 1:  E-mail  FTP  Out1  Save to SD card  Samba

Area 2:  E-mail  FTP  Out1  Save to SD card  Samba

Area 3:  E-mail  FTP  Out1  Save to SD card  Samba

Subject:

Interval:  a period of time between every two motions detected.

Based on schedule

**Tampering Detection**

Tampering:  Enabled  Disabled

E-mail  FTP  Out1  Save to SD card  Samba

Interval:

**Record File**

File Format:

**Record Time Setting**

Pre Alarm:

Post Alarm:

**Network Disconnected**

Disconnected:  Save to SD card

**Network IP Check**

IP Check:  Enabled  Disabled

IP Address:

Interval:

Check failed:  Connection failed four times. Reboot IP Camera.  
 Save to SD card

## Event Configuration >> Motion Detection

**LIVE VIEW**

**SYSTEM**

**NETWORK**

**AUDIO / VIDEO SETTING**

**EVENT CONFIGURATION**

Motion Detection

Sound Detection

Schedule

GPIO Setting

Logs

SD Card

**LOGOUT**

### Motion Detection

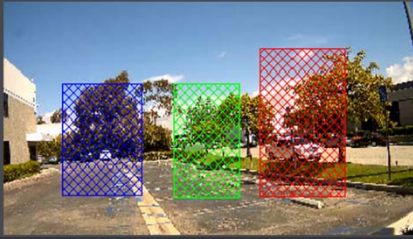

Area Setting: Area 1 Area 2 Area 3

Sensitivity: 5 5 5

Area 1:  E-mail  FTP  Out1  Save to SD card  Samba

Area 2:  E-mail  FTP  Out1  Save to SD card  Samba

Area 3:  E-mail  FTP  Out1  Save to SD card  Samba

Log:  E-mail  FTP  Samba

- **Area Setting:** Click **Area 1 /Area 2/Area 3** icon then draw the motion detection area on the live screen. If there is any motion detected in these areas, the "**Motion!**" wording will show on the live screen. To clean the motion detection area, click **Area 1 /Area 2/Area 3** icon again.
- **Sensitivity:** Select motion detection sensitivity from 1 to 10.
- **Trigger Action (Area 1, Area 2, Area 3):** When motion is detected, the camera can send video or snapshot to Email, FTP, Output device and Samba.
 

**Note:** Due to network/Internet bandwidth constraint, the IP camera may not transfer video to selected destinations simultaneously. Keep the number of destinations as few as possible to avoid possible data loss.
- **Subject:** This subject will appear as the subject when sending the motion detected video or snapshot to email.
- **Interval:** Each motion triggered in defined interval time. If you select "10 sec" here, once the motion is detected and action is triggered, the next motion will be trigger after 10 seconds. .

- **Based on the schedule:** The motion detection will be triggered based on the schedule you define.

#### Event Configuration >> Motion Detection >> Tampering Detection

Tampering Detection	
Tampering:	<input checked="" type="radio"/> Enabled <input type="radio"/> Disabled
	<input checked="" type="checkbox"/> E-mail <input checked="" type="checkbox"/> FTP <input checked="" type="checkbox"/> Out1 <input checked="" type="checkbox"/> Save to SD card <input checked="" type="checkbox"/> Samba
Interval:	30 sec ▼

- Tampering: Enable / Disable Tampering. When enabled and tampering is detected, the camera will send video or snapshot to Email, FTP, Output device or Samba.

#### Event Configuration >> Motion Detection >> Record File

Record File	
File Format:	AVI File( with Record Time Setting) ▼

When an event occurs, the IP camera can record a video clip or take snapshot, and then send the file to mail/ FTP/ Samba. Select what format you want to save.

- AVI File (with Record Time Setting): Save AVI video file. The video length is according to the value you set in Record Time Setting.
- JPEG File (Single File with Interval Setting): Save single JPEG picture file when event occurs.
- JPEG Files (with Record Time Setting): Only when you select "JPEG" in streaming 1 video format of Video Setting, this option can be enabled. Select this option to save several JPEG picture files, and the successive picture files cover a period of time according to the value you set in Record Time Setting.

#### Event Configuration >> Motion Detection >> Record Time Setting

Record Time Setting	
Pre Alarm:	5 sec ▼
Post Alarm:	5 sec ▼

When an event occurs, the IP camera can record a video clip or take snapshot, and then send to mail/ FTP/ Samba. Select the video recording length before and after event occurs.

#### Event Configuration >> Motion Detection >> Network Disconnected

Network Disconnected	
Disconnected:	<input checked="" type="checkbox"/> Save to SD card

When enabled, the live view will be stored into the SD card if the IP Camera has no Internet Connection (the SD card must be pre-installed).

#### Event Configuration >> Motion Detection >> Network IP Check

Network IP Check	
IP Check:	<input checked="" type="radio"/> Enabled <input type="radio"/> Disabled
IP Address:	www.google.com
Interval:	30 sec ▼
Check failed:	<input checked="" type="checkbox"/> Connection failed four times, Reboot IP Camera. <input checked="" type="checkbox"/> Save to SD card

Enter the target IP address and interval. The camera will base on the interval time to check the target IP address. If PIN failed 4 times, the camera itself will reboot.

Event Configuration >> Sound Detection >> Sound Detection

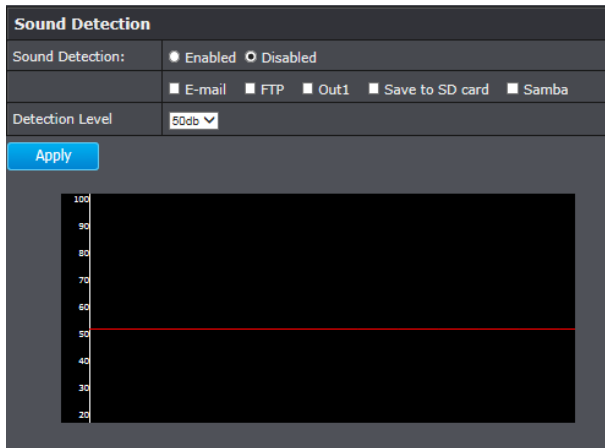

- When enabled and the camera detects sound, the IP camera can record a video clip or take snapshot, and then send the file to mail/ FTP/ Samba. Select what format you want to save.
- Detection Level: Selects the decibels value (for the camera to trigger sound detection).

Event Configuration >> Schedule

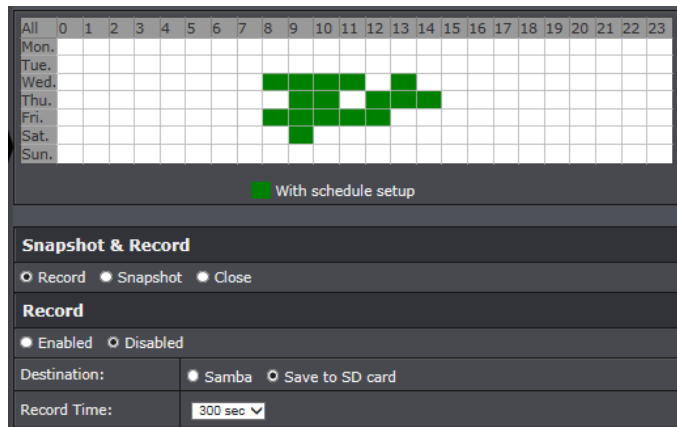

Click on the week calendar to draw color. The actions will be performed during the colored time.

When **Record** is enabled:

- Enabled / Disabled
- **Destination:** Select between sending the record to Samba or saving it into the SD card
- **Record Time:** Select the video length (seconds)

When **Snapshot** is enabled:

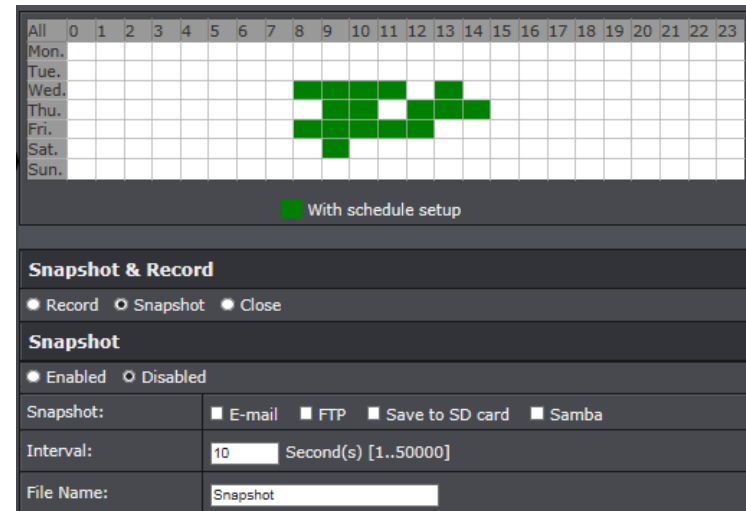

- When enabling the snapshot function, the IP camera will take snapshot according to schedule. Select the snapshot saving way: E-mail, FTP, or Samba.
- **Interval:** The interval between two snapshots.
- **File Name:** Give the snapshot file name. The saved file will be named as: "(file name) - (saving date) - (saving time)"



Event Configuration >> GPIO Setting

Input Setting	
Input 1 Sensor:	N.O
Input 1 Action:	<input type="checkbox"/> E-mail <input type="checkbox"/> FTP <input type="checkbox"/> Out1 <input type="checkbox"/> Save to SD card <input type="checkbox"/> Samba
Subject:	GPIO In Detected!
Interval:	10 sec
<input checked="" type="checkbox"/> Based on schedule	
Output Setting	
Mode Setting:	<input type="radio"/> On/Off Switch <input checked="" type="radio"/> Time Switch
Interval:	10 sec

1. I/O Connection

- Please connect the GND & DO pin to the external relay (buzzer) device.

When no event occurs, DO output is 5V (DO and GND are disconnected). When the camera detects event happening and triggers external alarm, DO output is 0V (DO and GND are connected).

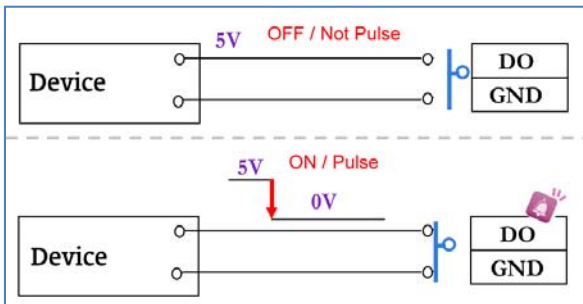

- Please connect the GND & DI pin to the external trigger device.

If you select "N.O" in "Input sensor setting", when external device or circuit makes DI and GND pin connected, the camera input alarm is triggered, and then camera will execute the action user has set, for example, send snapshot to E-mail address.

If you select "N.C" in "Input sensor setting", when external device or circuit makes DI and GND pin disconnected, the camera input alarm is triggered, and then camera will execute the action user has set, for example, send snapshot to E-mail address.

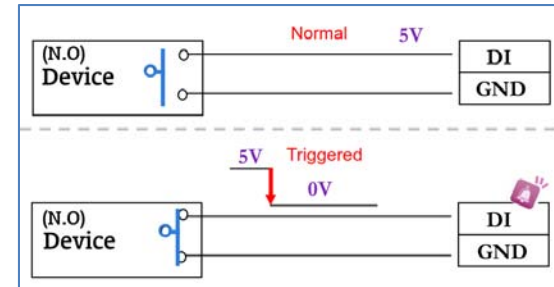

GPIO PIN definition

GND (Ground): Initial state is LOW

DO (Digital Output): DC 5V

DI (Digital Input): Max. 50mA, DC 5V

2. GPIO Setting

Event Configuration >> GPIO Setting >> Input Setting

- **Input Sensor:** According to your external device and circuit design, select N.O (normally open) or N.C (normally closed).
- **Input Action:** When the camera input alarm is triggered, it can trigger the relay out, or send the video to E-mail/ FTP/ SAMBA.
- **Interval:** If you select "10 sec" here, once the input alarm is detected and action is triggered, it cannot be triggered again within 10 seconds.
- **Based on the schedule:** When click the option box, only during the selected schedule time the I/O is enabled. That is, for example, the 11th hour of Monday has not been colored in the schedule table, then no action will be triggered even the camera detects input signal during 11:00~12:00 on Monday.

## Event Configuration &gt;&gt; GPIO Setting &gt;&gt; Output Setting

- **Mode Setting**

- On/Off Switch:

When event occurs, the camera triggers the external device and lasts for certain of time according to the event "interval" setting. If it's triggered by motion detection, the triggering time is according to "interval" setting of motion detection. If it's triggered by external input alarm, the triggering time is according to input "interval" setting. It triggers the external device and lasts for 10 seconds if you select "10" in interval setting. You can turn off the alarm manually by click "off" at the bottom-right of the live screen page.

- Time Switch:

When event occurs, the camera triggers the external device and lasts for certain of time according to the output "interval" setting, and the user is not allowed to break off the alarm manually.

### 3. Output Test

After the external output hardware is installed, you can use the "Relay Out" button on the live video page to test if DO device works.

- **On/Off Switch mode:**

Click "ON", the camera will trigger the external output device. For example, your alarm buzzer will continuously ring. You can manually break off the output signal by clicking "OFF".

- **Time Switch mode:**

Click "Pulse", the camera will trigger the external output device for several seconds. The duration length is according to the "interval" setting in Output Setting.

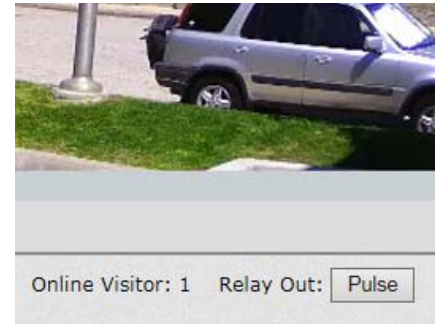

## Event Configuration &gt;&gt; Logs

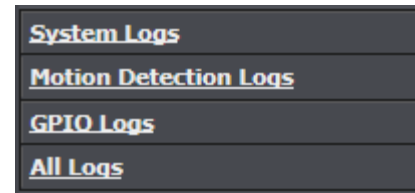

Click "Logs" to see **System Logs**, **Motion Detection Logs**, **GPIO Logs** and **All Logs**. If you remove the power from IP camera, **Motion Detection Logs** will be cleared away.

Event Configuration >> SD Card

### SD Card

---

#### Event Record

- [20140604](#)
- [20140605](#)
- [20140606](#)
- [20140608](#)
- [20140609](#)
- [20140610](#)
- [20140611](#)

#### Schedule Record

- [20140903](#)

SD Card: << 29624M / 30172M >>

#### SD Management

Auto Deletion: Delete after the Off

#### Format SD Card

Click on the button to format your SD Card. Note, all data on your SD Card will be permanently deleted.

Format SD Card

Apply

- **Playback: Event Record**

2014/06/04			
Time	Video	Event Type	Del
02:34:25	<a href="#">023425m.avi</a>	Motion Detection	■
03:56:02	<a href="#">035602m.avi</a>	Motion Detection	■
03:56:13	<a href="#">035613m.avi</a>	Motion Detection	■
16:58:04	<a href="#">165804m.avi</a>	Motion Detection	■
17:01:41	<a href="#">170141m.avi</a>	Motion Detection	■

The record data that triggered by motion detection, sound detection, tampering detection, or GPIO is listed here. Click the date listed on this page, and it shows the list of the video. Click the video to download and start your player to play the .avi file. To delete the video, check it, then click "Del".

- **Playback: Schedule Record**

2014/09/03			Del
Time	Video	Event Type	■
02 o'clock	<a href="#">02 o'clock</a>	Schedule Snapshot Record	■
02 o'clock	<a href="#">02 o'clock</a>		■

[Files link daily .](#)

The scheduled record data or scheduled snapshot are listed here. Click the date listed on this page, and it shows the list of the snapshot and the video. Click the video to download and start your player to play the .avi file. Click the snapshot to watch the album. To delete the file, check it, then click "Del".

- **SD Management**

#### SD Management

Auto Deletion: Delete after the 1st day

Delete after the "1<sup>st</sup> day" means the recorded files will be deleted after 1<sup>st</sup> day from the time you decided to delete. For example: if right now is 5 pm, when you choose **Delete after the 1st day**, the SD card will keep the file from 5 pm yesterday to 5 pm today. The rest of recorded files will be deleted.

The oldest file will be deleted if the Micro SD card is full.

Note: The use of the SD card will affect the operation of the IP Camera slightly, such as affecting the frame rate of the video.

## LOGOUT

LIVE VIEW	<b>Network Setting</b>
SYSTEM	
NETWORK	<b>IP Address Setting</b>
Network Setting	<input checked="" type="radio"/> DHCP <input type="radio"/> Static
Advanced	IP Address: <input type="text" value="192.168.1.141"/>
HTTPS	Subnet Mask: <input type="text" value="255.255.255.0"/>
SNMP	Gateway: <input type="text" value="192.168.1.254"/>
IP Address Filter	DNS 1: <input type="text" value="192.168.1.249"/>
QoS/DSCP	DNS 2: <input type="text" value="168.95.192.1"/>
IEEE 802.1x	<b>IPv6 Setting</b>
PPPoE & DDNS	<input checked="" type="checkbox"/> IPv6 Enabled:
Event Server	<input checked="" type="checkbox"/> Manually setup the IPv6 address:
AUDIO / VIDEO SETTING	DHCPv6: <input type="radio"/> Enabled <input type="radio"/> Disabled
EVENT CONFIGURATION	IPv6 Address: fe80::20f:dff:fe26:9a30
LOGOUT	<b>Port Setting</b>
	Web Page Port: <input type="text" value="80"/>
	HTTPS Port: <input type="text" value="443"/> <a href="#">HTTPS Setting</a>
	<b>Web Authentication</b>
	Authentication: <input type="text" value="Digest"/>

Click "LOGOUT" button to logout the camera. Note: Closing the browser does not logout the camera. It will remain in the same session. If camera in the idle time for 3 minutes, it will automatic logout the session.

## Accessing the camera with Chrome

If you are viewing or configuring the camera by using the Chrome browser, please follow below steps.

1. Click on **Install** button if you are logging into the camera for the first time using Chrome, otherwise, click **Launch**.

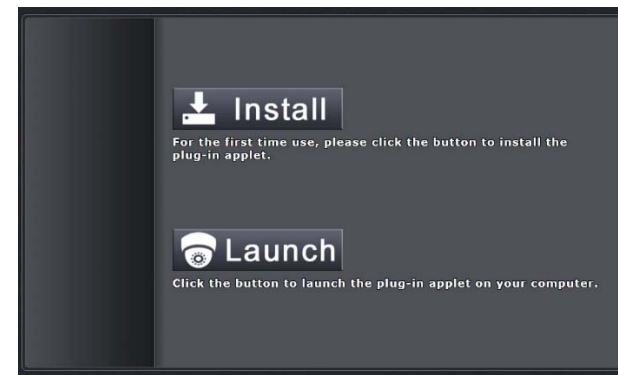

2. You will be redirect to a Chrome plug in page, click on **Add to Chrome** to activate this feature then click on **Add App**.

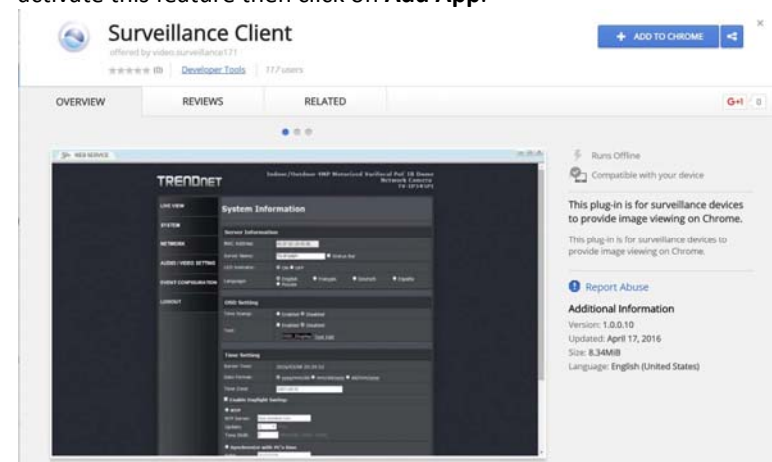

- The camera app will be added to Chrome browser, click on **Surveillance Client** to launch the camera page.

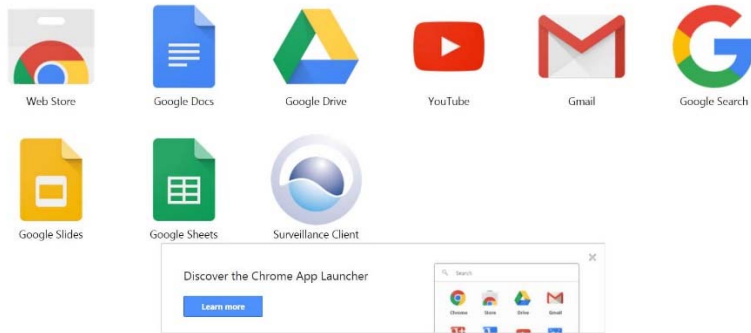

- Enter the IP address of the camera on the address bar and click Go.

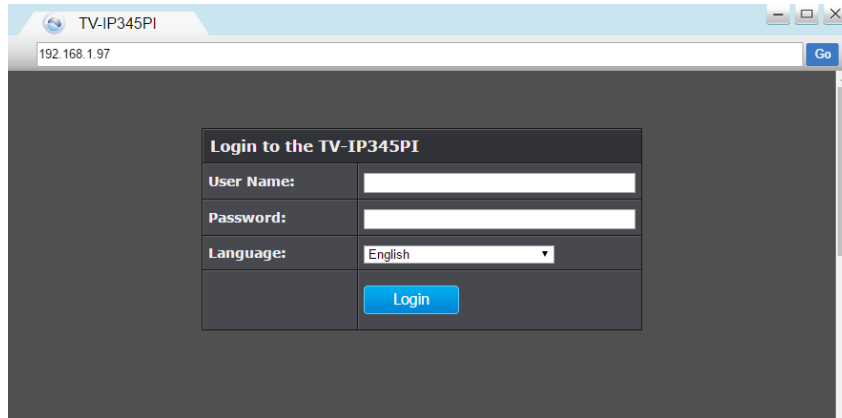

- Enter the user name and password to access the camera's live view and configuration page.

## Troubleshooting

- I inserted the Utility CD-ROM into my computer's CD-ROM Drive but the installation menu does not appear automatically. What should I do?

### Windows 10/8/8.1

If the installation menu does not appear automatically, press the windows icon and press "r" simultaneously. In the "run" box, type D:\autorun.exe, where "D" in "D:\autorun.exe" is the letter assigned to your CD-ROM Drive, and then press the ENTER key on your keyboard .

### Windows 7

If the installation menu does not appear automatically, click on the Windows Icon on the bottom left hand corner of the screen, click the "Search programs and files" box, and type D:\autorun.exe, where "D" in "D:\autorun.exe" is the letter assigned to your CD-ROM Drive, and then press the ENTER key on your keyboard .

### Windows Vista

If the installation menu does not appear automatically, click Start, click the Start Search box, and type D:\autorun.exe where "D" in "D:\autorun.exe" is the letter assigned to your CD-ROM Drive, and then press the ENTER key on your keyboard.

### Windows XP

If the window does not appear automatically, click Start, click Run and type D:\autorun.exe where "D" in "D:\autorun.exe" is the letter assigned to your CD-ROM Drive, and then press the ENTER key on your keyboard.

**2. The autorun program is unable to detect my camera. What should I do?**

- a. Verify that you have followed all the steps in Section 2: Hardware Installation.
- b. Disable any software firewall programs such as ZoneAlarm or Norton Internet Security. If you are using Windows 8, 7, Vista or XP, disable the built in firewall.
- c. Reset the IP Camera
- d. Run the Autorun program from the CD-ROM again.

**3. I do not have a DHCP server or DHCP is disabled on my network and I am unable to configure the camera. What should I do?**

- a. Go to the TCP/IP settings on your computer and assign a static IP address on your computer's network adapter in the subnet of 192.168.10.x. Since the default IP address of the camera is 192.168.10.30, do not assign a static IP address of 192.168.10.30 on your computer's network adapter.
- b. Open Internet Explorer and enter <http://192.168.10.30> into the address bar.

**4. I forgot my password. What should I do?**

Please follow the steps below to reset to factory default setting

- a. Remove the power and network cable

- b. Take the included Reset Wire Cable, plug one side of the wire into "Default" and the other side into "GND" on the terminal block as shown below.

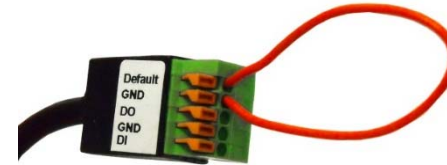

- c. Connect power to the camera again. It takes around 30 seconds to boot the camera.
- d. Remove the wire and plug in the network cable after the camera finishes booting.
- e. Run the Install Camera wizard from the CD-ROM to login to the camera.

## Limited Warranty

---

TRENDnet warrants its products against defects in material and workmanship, under normal use and service, for the following lengths of time from the date of purchase.

### TV-IP345PI – 3 Years Limited Warranty

AC/DC Power Adapter, Cooling Fan, and Power Supply carry 1 year warranty.

If a product does not operate as warranted during the applicable warranty period, TRENDnet shall reserve the right, at its expense, to repair or replace the defective product or part and deliver an equivalent product or part to the customer. The repair/replacement unit's warranty continues from the original date of purchase. All products that are replaced become the property of TRENDnet. Replacement products may be new or reconditioned. TRENDnet does not issue refunds or credit. Please contact the point-of-purchase for their return policies.

TRENDnet shall not be responsible for any software, firmware, information, or memory data of customer contained in, stored on, or integrated with any products returned to TRENDnet pursuant to any warranty.

There are no user serviceable parts inside the product. Do not remove or attempt to service the product by any unauthorized service center. This warranty is voided if (i) the product has been modified or repaired by any unauthorized service center, (ii) the product was subject to accident, abuse, or improper use (iii) the product was subject to conditions more severe than those specified in the manual.

Warranty service may be obtained by contacting TRENDnet within the applicable warranty period and providing a copy of the dated proof of the purchase. Upon proper submission of required documentation a Return Material Authorization (RMA) number will be issued. An RMA number is required in order to initiate warranty service support for all TRENDnet products. Products that are sent to TRENDnet for RMA service must have the RMA number marked on the outside of return packages and sent to TRENDnet prepaid, insured and packaged appropriately for safe shipment. Customers shipping from outside of the USA and Canada are responsible for return shipping fees. Customers shipping from outside of the USA are responsible for custom charges, including but not limited to, duty, tax, and other fees.

**WARRANTIES EXCLUSIVE:** IF THE TRENDNET PRODUCT DOES NOT OPERATE AS WARRANTED ABOVE, THE CUSTOMER'S SOLE REMEDY SHALL BE, AT TRENDNET'S OPTION, REPAIR OR REPLACE. THE FOREGOING WARRANTIES AND REMEDIES ARE EXCLUSIVE AND ARE IN LIEU OF ALL OTHER WARRANTIES, EXPRESSED OR IMPLIED, EITHER IN FACT OR BY OPERATION OF LAW, STATUTORY OR OTHERWISE, INCLUDING WARRANTIES OF MERCHANTABILITY AND FITNESS FOR A PARTICULAR PURPOSE. TRENDNET NEITHER ASSUMES NOR AUTHORIZES ANY OTHER PERSON TO ASSUME FOR IT ANY OTHER LIABILITY IN CONNECTION WITH THE SALE, INSTALLATION MAINTENANCE OR USE OF TRENDNET'S PRODUCTS.

TRENDNET SHALL NOT BE LIABLE UNDER THIS WARRANTY IF ITS TESTING AND EXAMINATION DISCLOSE THAT THE ALLEGED DEFECT IN THE PRODUCT DOES NOT EXIST OR WAS CAUSED BY CUSTOMER'S OR ANY THIRD PERSON'S MISUSE, NEGLIGENCE, IMPROPER INSTALLATION OR TESTING, UNAUTHORIZED ATTEMPTS TO REPAIR OR MODIFY, OR ANY OTHER CAUSE BEYOND THE RANGE OF THE INTENDED USE, OR BY ACCIDENT, FIRE, LIGHTNING, OR OTHER HAZARD.

LIMITATION OF LIABILITY: TO THE FULL EXTENT ALLOWED BY LAW TRENDNET ALSO EXCLUDES FOR ITSELF AND ITS SUPPLIERS ANY LIABILITY, WHETHER BASED IN CONTRACT OR TORT (INCLUDING NEGLIGENCE), FOR INCIDENTAL, CONSEQUENTIAL, INDIRECT, SPECIAL, OR PUNITIVE DAMAGES OF ANY KIND, OR FOR LOSS OF REVENUE OR PROFITS, LOSS OF BUSINESS, LOSS OF INFORMATION OR DATE, OR OTHER FINANCIAL LOSS ARISING OUT OF OR IN CONNECTION WITH THE SALE, INSTALLATION, MAINTENANCE, USE, PERFORMANCE, FAILURE, OR INTERRUPTION OF THE POSSIBILITY OF SUCH DAMAGES, AND LIMITS ITS LIABILITY TO REPAIR, REPLACEMENT, OR REFUND OF THE PURCHASE PRICE PAID, AT TRENDNET'S OPTION. THIS DISCLAIMER OF LIABILITY FOR DAMAGES WILL NOT BE AFFECTED IF ANY REMEDY PROVIDED HEREIN SHALL FAIL OF ITS ESSENTIAL PURPOSE.

**Governing Law:** This Limited Warranty shall be governed by the laws of the state of California.

Some TRENDnet products include software code written by third party developers. These codes are subject to the GNU General Public License ("GPL") or GNU Lesser General Public License ("LGPL").

Go to <http://www.trendnet.com/gpl> or <http://www.trendnet.com> Download section and look for the desired TRENDnet product to access to the GPL Code or LGPL Code. These codes are distributed WITHOUT WARRANTY and are subject to the copyrights of the developers. TRENDnet does not provide technical support for these codes. Please go to <http://www.gnu.org/licenses/gpl.txt> or <http://www.gnu.org/licenses/lgpl.txt> for specific terms of each license.

05.25.2019 1.01

# TRENDnet<sup>®</sup>

## Product Warranty Registration

Please take a moment to register your product online.  
Go to TRENDnet's website at <http://www.trendnet.com/register>

TRENDnet  
20675 Manhattan Place  
Torrance, CA 90501. USA