

User's Guide



TRENDNET®



4-Port Powerline 500 AV Adapter

TPL-4052E

Table of Contents

Product Overview	1	Powerline Utility - Map View	14
Package Contents.....	1	Powerline Utility - Detailed View	16
Features	1	Powerline Utility - Device Setup	17
Product information on device label	2	Powerline Utility - Advanced	18
Push Buttons.....	3	Powerline Utility - Options.....	19
Diagnostic LEDs.....	3	Powerline Utility - About	20
Application Diagram	4	Technical Specifications	21
Install Your Powerline Adapter	5	Troubleshooting	22
Before you Install	5	Appendix.....	23
Connect a Powerline Adapter to your router	5	Overlapping powerline networks	23
Add adapters to your network.....	6	Move Powerline Adapters between different overlapping powerline networks	23
Secure Your Powerline Network	7	Federal Communication Commission Interference Statement.....	25
Using the Sync button.....	7	RoHS	25
Change the network name and associate two Powerline Adapters:	8	Europe – EU Declaration of Conformity.....	25
Add adapters using the Sync button.....	8	Limited Warranty	27
Configure an additional Powerline Adapter to connect and use the network name of your existing powerline network:.....	9		
Using the Powerline Utility	9		
Powerline Utility System Requirements.....	10		
Software Installation.....	10		
Using the Utility	13		

Product Overview



TPL-4052E

Package Contents

TPL-4052E package includes:

- TPL-4052E: 4-Port Powerline 500 AV Adapter
- Multi-language Quick Installation Guide
- CD-ROM (Utility & User's Guide)
- Network cable (1.5 m / 5 ft.)

Features

TRENDnet's 4-Port Powerline 500 AV Adapter, model TPL-4052E, uses an electrical outlet to create a 500 Mbps powerline network. Two adapters are needed to start a network. Connect network ready TVs, media players, game consoles, and computers to the four Ethernet ports. No CD installation required—encrypted TRENDnet adapters auto-connect out of the box. This adapter will automatically connect to other out of box TRENDnet Powerline AV adapters. No installation required. (To add up privacy on top of your network, TRENDnet recommends using button pressing sequence to scramble network name instead leave the key public as set in default.) Power saving mode reduces up to 80% electric consumption when network is idle. QoS, Quality of Service, technology prioritizes video, audio, and online gaming, smoothing your streaming experience. LED lamps indicate device and port status for network monitoring and easy troubleshooting. Advanced AES encryption secures your network. This adapter is ideal for use in buildings that interfere with wireless networking signals.

- Compliant with IEEE1901 and HomePlug AV standards
- High speed networking over an existing electrical system
- 4 x 10/100 Mbps Auto-MDIX Fast ports
- One-touch Sync button networks adapters quickly
- Three LED indicators: Power (on/off), Powerline Link (green (best), amber (better), red (good), off(no connection), Ethernet Link (solid, blinking, off)
- Connect one Powerline 500 AV Adapter to the Internet and then plug in up to 15* additional Powerline 500 AV Adapters for instant connectivity
- Share data intensive files, play games, download music and more at faster data transfer rates
- Advanced 128-bit AES encryption to ensure total network security
- Power Save mode reduces electric consumption by 80%
- Network signal transmits up to 300 meters (984ft.)
- Auto QoS support through traffic classification and multiple priority queuing

- Optional management utility compatible with Windows 8 (32/64-bit), Windows

* 8 active adapter can stream data at the same time. Up to 16 adapters can be configured in the same network. Additional adapters may decrease network performance. 500Mbps is the maximum theoretical powerline data rate. Actual throughput will vary depending on the environment. Networked Powerline devices must be plugged into power outlets that are on the same electrical system. GFCI outlets and AFCI circuit breakers may degrade powerline network signals.

Product information on device label

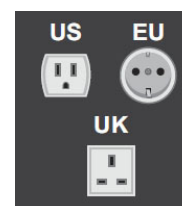
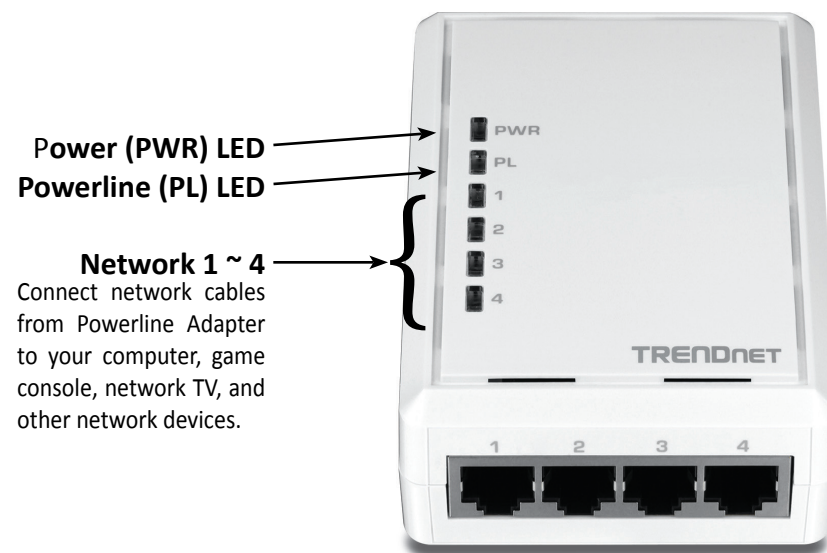
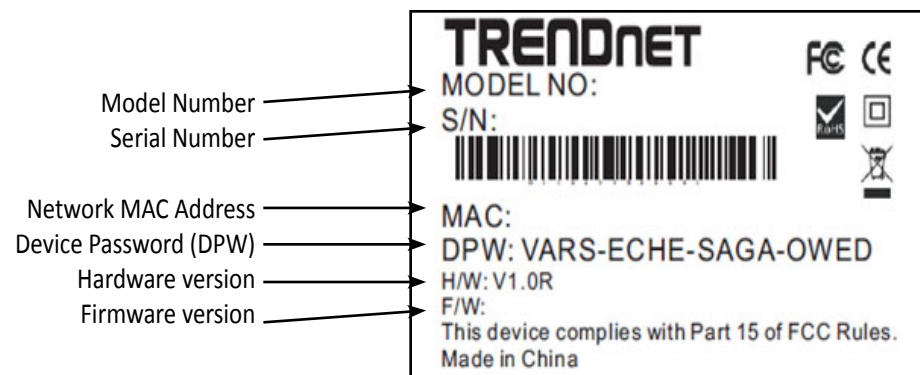

Power plug
 Plugs directly into an available power outlet.
 Not on power strip.



Reset button
 Resets the unit to factory defaults.

Sync button
 Synchronize with other Powerline Adapters.

Push Buttons

Button	Action	Function
Sync (see Using the Sync Button Section for instructions)	Push and hold for 2 seconds	Initiate Sync/Connection and generate random private network name on first adapter (PWR LED will start blinking).
		Match the network name on secondary or additional adapter and connect to first adapter. (PWR LED will start blinking) Note: To establish connectivity, the secondary or additional Powerline Adapter's Sync button must also be pushed within 2 minutes (120 sec) of pushing the Sync button of the first adapter.
	Push/hold for 15 seconds	Erases the network name (All LEDs will turn off and turn back on).
Reset	Push/hold for 1 second only	Reset device to factory defaults (All LEDs will turn off and turn back on). Note: Will reset to the factory default private network name "HomePlug AV".

Save Mode: The device will automatically standby to reduce power usage when there is no network traffic for more than 10~20 minutes. It will automatically resume back to full speed service when traffic resumes.

Diagnostic LEDs

Indicates the device and connection status

LED	Color	Sequence	Definition
PWR (Power)	Green	Solid	Device powered on
	N/A	Off	Device powered off
PL (Powerline)	Green	Solid	Powerline connected (Best)
		Blinking	Syncing or Powerline data transmitting/receiving (Best)
	Amber	Solid	Powerline connected (Better)
		Blinking	Powerline data transmitting/receiving (Better)
	Red	Solid	Powerline connected (Good)
		Blinking	Powerline data transmitting/receiving (Good)
N/A	Off	Powerline is not synced or connected	
1-4 (Fast Ethernet Connection)	Green	Solid	Network connection established
		Blinking	Data transmission is detected
	N/A	Off	Network standby or no network connection

Note: Powerline (PL) LED color indicates the strength and quality of the Powerline connection through the electrical system. The following factors may affect the powerline network's connection quality:

- **Noise** – Generated by appliances which use your electrical system (e.g. Microwaves, ovens, hair dryer, irons, dishwashers, etc.). The quality of your household electrical wiring may also cause additional noise on your electrical system.
- **Distance** – Long lengths of electrical wiring through your electrical system between connected Powerline Adapters.

Application Diagram

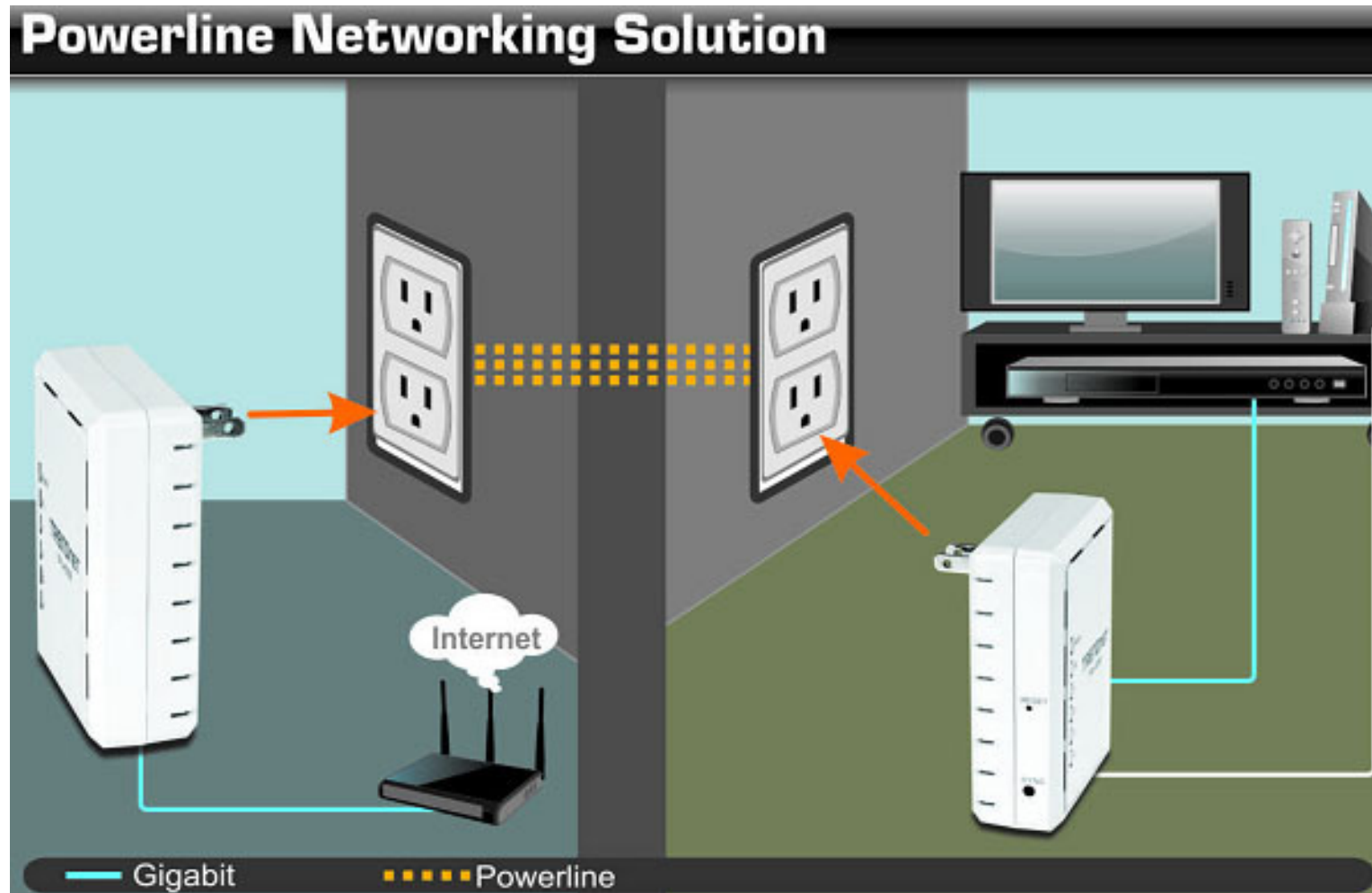

Diagram Explanation:

The first Powerline unit is networked to a router which is in turn connected to a modem (typically supplied by your Internet Service Provider (ISP)) that provides Internet connectivity. A second Powerline Adapter is plugged into a wall power outlet near a media center and is providing Internet connectivity to a game console and a Blu-ray player / media player via Ethernet.

Installing Your Powerline Adapter

Before you install

- Before you proceed with the installation, verify the following:
 - Verify that you already have Internet access through your existing network.
 - Verify that you have an available Ethernet port (also known as a LAN port) on your router.
 - Verify that you have at least two Powerline Adapters. Two or more Powerline Adapters are required to create a powerline network.

Note: The TPL-4052E package only includes a single Powerline Adapter. Please ensure that your other Powerline Adapter is HomePlug® AV or IEEE 1901 compliant (e.g. TRENDnet models TPL-401E, TPL-402E, TPL-405E, TPL-406E, TPL-407E or another TPL-4052E.)
- Plan the location of where you will install your Powerline Adapters.
 - Avoid plugging the adapters into power strips, extension cords, or surge protectors as this may prevent the adapter from functioning correctly or degrade performance.
 - Avoid plugging the adapters into wall power outlets that are controlled by a light switch to prevent the Powerline Adapter from being turned off accidentally.
 - Avoid plugging the adapters into wall power outlets that are located near appliances that consume a lot of power (e.g. refrigerators, washers, dryers) as this may degrade performance.
 - Make sure there is an available wall power outlet in the room where the router is installed and also near the router.
 - Make sure there is an available wall power outlet in the room where you want to extend network connectivity.

Connecting a Powerline Adapter to your router

- Plug the Powerline Adapter into an available wall power outlet near your router.

Note: This will allow devices connected to your powerline network to access the Internet and other devices connected to your network.
- Connect the included Ethernet cable (also called a network cable) from the Ethernet port (also called network port) of your Powerline Adapter to an available Ethernet port (also called LAN port) on your router.
- Once the Powerline Adapter is installed and connected to your router, verify that the **Power (PWR) LED** is on or blinking and the Network LED is on or blinking.

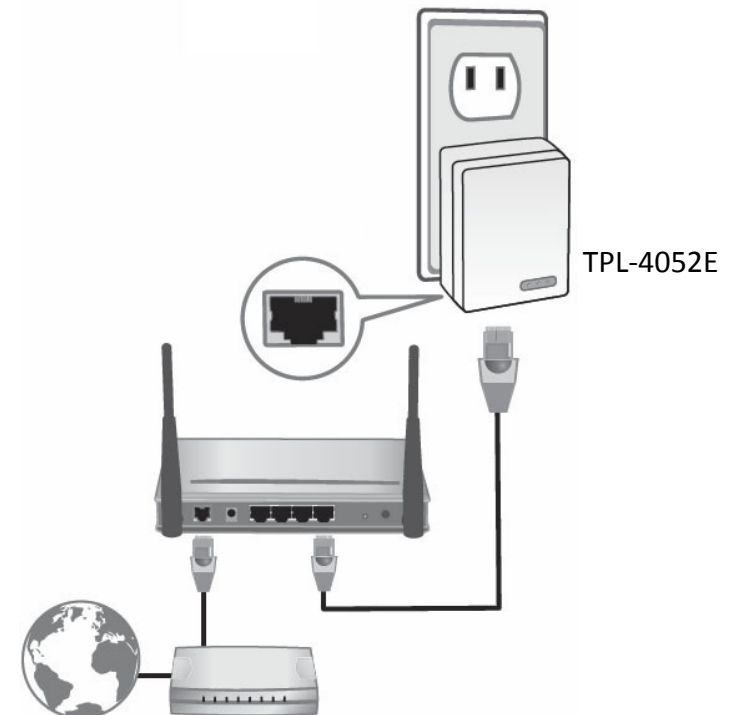

Adding adapters to your network

Once you have installed and connected the first Powerline Adapter to your router, you can easily extend your network to other rooms by adding additional Powerline Adapters.

To extend your network using an additional Powerline Adapter:

1. First, make sure the first Powerline Adapter is installed and connected to your router.

Note: This will allow devices connected to your powerline network to access the Internet and other devices connected to your network. See "Connecting a Powerline Adapter to your router" on page 5.

2. Plug in the additional Powerline Adapter to an available wall power outlet in another room near a computer or network device (e.g. game consoles, network-enabled TVs, network attached storage, network media server/players, etc.) you want to connect to your network.

3. Connect one end of the included Ethernet cable to the Ethernet port on your Powerline Adapter and then connect the other end to the Ethernet port on your computers or another network enabled device.

4. After the additional Powerline Adapter is connected and installed to your computer or network device, wait for the **Powerline (PL)** LED to turn on. After the **Powerline (PL)** LED turns on, verify that the **Power (PWR)** LED is on, the **Powerline (PL)** LED is on or blinking, and the **network LED** is on or blinking.

Note: To verify that your Powerline Adapters are connected successfully

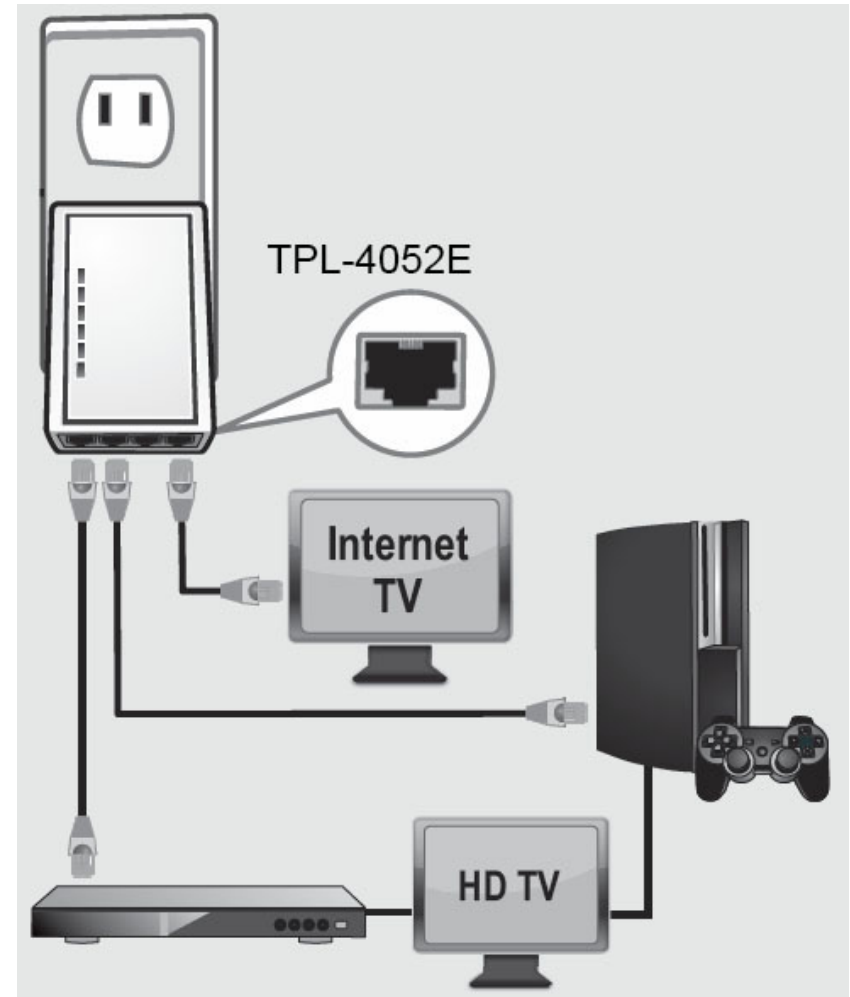

to your network, you can check if the computer(s) or network device(s) can access the Internet through your powerline network.

To install additional Powerline Adapters in other rooms, repeat the steps above for each adapter.

Secure Your Powerline Network

Powerline Adapters join powerline network by using network name. The default network name is "HomePlugAV". All out-of-the-box TRENDnet HomePlugAV Powerline Adapters have the same default network name and can be connected to each other without further configuration. To add network security to your network, you can change your Powerline network name away from the factory default name. With a private custom network name, no one can connect to your Powerline network with an out-of-the-box HomePlugAV adapter.

TRENDnet recommends you change the Powerline network name away from the factory default name to increase network security. Once configured, the Powerline network name will be saved. The adapter can be moved freely within its operating range without having to reconfigure the network name. If a mistake is made in the settings, the adapter can be reset to the factory default settings by pressing the reset **Reset** button for 1 second.

There are two ways to change the default network name:

1. (Recommended) Use the physical **Sync** button on your Powerline Adapter to generate a random private network name. See "Using the Sync Button" in next section.

OR

2. Create a customized private network name for your powerline network by using the included Powerline Utility. See "Using the Powerline Utility" on page 9".

* If the Powerline Adapter settings have been changed, the adapter must be reset to the factory default settings to be recognized by Powerline Utility.

Using the Sync button

Change your default network name using the Sync button

The physical **Sync** button on the Powerline Adapter provides an easy method of changing the network name. The **Sync** button generates a random network name for your powerline network. To create a customized network name, see "Using the Powerline Utility" on page 9.

Note: The default network name assigned to TRENDnet Powerline Adapters is **HomePlugAV**. Before changing the default network name, please make sure your Powerline Adapters are already installed and connected using the default network name.

See "Installing Your Powerline Adapter" on page 5.

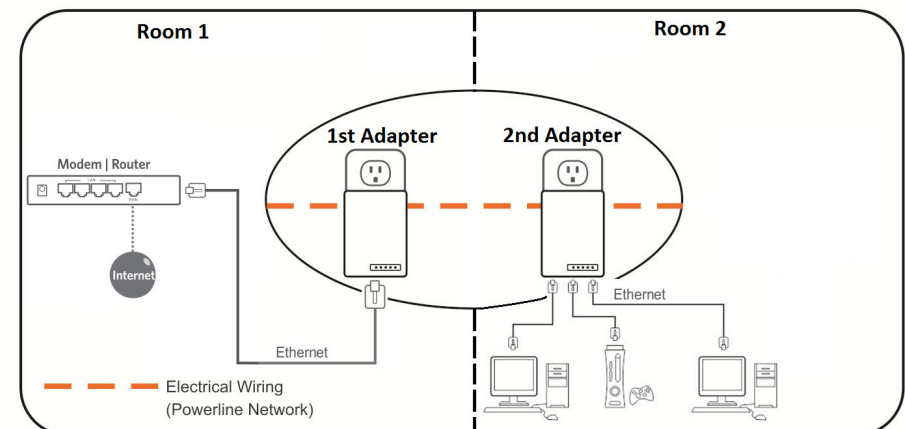

Changing the network name and associating two Powerline Adapters:

Note: Use the Sync button procedure below if you are connecting TRENDnet Powerline models TPL-401E, TPL-402E, TPL-405E, TPL-406E, TPL-407E or TPL-4052E.

1. Verify that all Powerline Adapters are already installed and connected using the default network name, see "Installing Your Powerline Adapter" on page 5.

Prepare your adapters:

2. On one of the connected Powerline Adapters, push and hold the **Sync** button for 15 seconds and then release it. All LEDs will turn off and turn back on. This will erase the current network name assigned to the first Powerline Adapter.

Note: Once you have completed this step, the other Powerline Adapter will no longer be able to communicate to this Powerline Adapter.

3. On the other Powerline Adapter, push and hold the **Sync** button for 15 seconds then release it. All LEDs will turn off and turn back on. This will erase the current network name assigned to the second Powerline Adapter.

Start association:

4. Within 2 minutes, push and hold the **Sync** button on the first Powerline Adapter for 2 seconds and then release it. The **Power (PWR) LED** will start blinking. This will generate a random network name on the first Powerline Adapter.

5. Push and hold the **Sync** button on the second Powerline Adapter for 2 seconds and release it. The **Power (PWR) LED** will start blinking. This will create a connection between both Powerline Adapters using

the new network name. All LEDs will turn off and turn back on and the **Powerline (PL) LED** will turn on when adapters are connected.

Adding adapters using the Sync button

If you have changed the default network name assigned to your Powerline Adapters, additional adapters will not automatically connect to your powerline network after they are plugged into a wall power outlet. You have to change the network name on additional Powerline Adapter in order to join your existing powerline network.

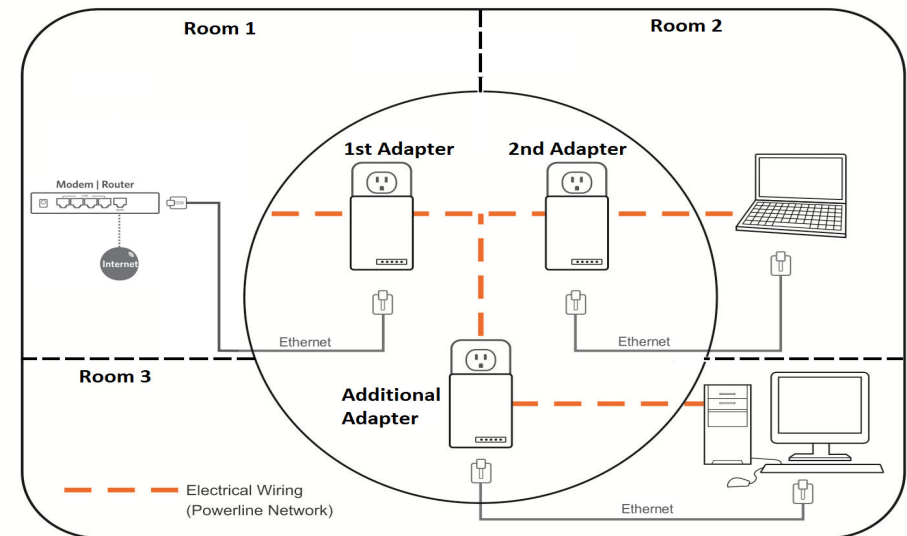

Configuring an additional Powerline Adapter to connect and use the network name of your existing powerline network:

Note: Use the Sync button procedure below if you are connecting TRENDnet Powerline models TPL-401E, TPL-402E, TPL-405E, TPL-406E, TPL-407E or TPL-4052E.

1. Verify that all existing Powerline Adapters are already installed and connected.

Prepare your adapter:

2. Push and hold the **Sync** button on the additional Powerline Adapter for 15 seconds and then release it. All LEDs will turn off and turn back on. This will erase the current network name assigned to the additional Powerline Adapter.

Start association:

3. Push and hold the **Sync** button on one of the existing Powerline Adapters connected to your powerline network for 2 seconds and then release it. The **Power (PWR) LED** will start blinking.
4. Within 2 minutes, push and hold the **Sync** button on the additional Powerline Adapter for 2 seconds and release it. The **Power (PWR) LED** will start blinking. This will reconfigure your additional Powerline Adapter to connect and use the network name of your existing powerline network. All LEDs will turn off and turn back on and the **Powerline (PL) LED** will turn on the adapters are connected.

Configure to add additional Powerline Adapters to your existing powerline network, repeat the steps above for each adapter.

Using the Powerline Utility

The Powerline Utility allows you doing following jobs:

1. Create a customized network name for your powerline network and apply it to multiple Powerline Adapters at the same time.
2. View Powerline Adapters connected to your network (using the MAC address) and the approximate connection quality and speed of each Powerline Adapter.
3. View and upgrade Powerline Adapter firmware.

Note: Link speed displayed in the utility of your Powerline Adapters to another through your electrical system is estimated. Actual link speed may vary.

Before installing and using the utility, please ensure the following:

1. Write down the **Device Password (DPW)** (16-digit characters A-Z only) and **MAC Address** (12-digit characters a-f, A-F, 0-9) of each Powerline Adapter as this will be required to change the network name for multiple Powerline Adapters. See "Product information on device label" on page 2.
2. Make sure your computer in which you are installing the utility is connected to your network and your Powerline Adapters are also connected to your network.
3. If you have changed your network name using the **Sync** button and you are creating a customized network name, it is required to reset all powerline devices to factory defaults using the physical **Reset** button on your Powerline Adapter before using the utility. See "Push Buttons" on page 3.
4. Please ensure that your Powerline Adapters are already installed and connected and the Ethernet port on each adapter is connected to a device powered on.

Powerline Utility System Requirements

- Windows 8 (32/64-bit), Windows 7 (32/64-bit), Windows Vista (32/64-bit), or Windows XP (32/64-bit)
- Microsoft® .NET Framework 3.5 installed

Software Installation

1. Insert the included CD-ROM into your computer's CD-ROM drive.

2. At the CD Autorun Prompt window, click *Run Autorun.exe* .

Note: If the Autorun prompt does not appear automatically, open the CD contents and double-click *Autorun.exe*.

3. At the CD-ROM main menu, click **Install Utility**.

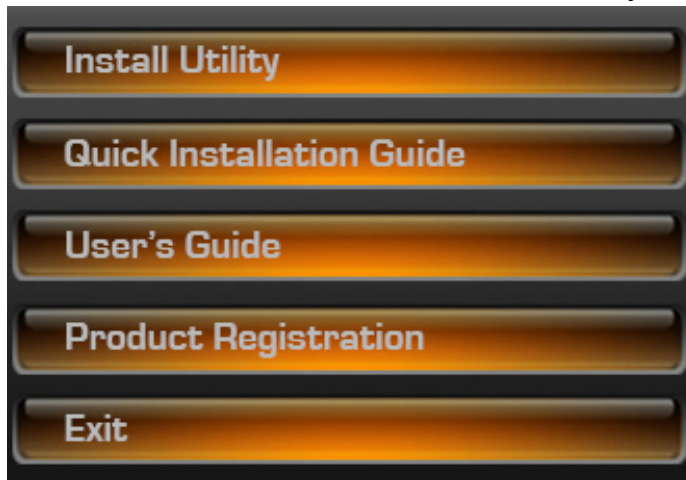

The installer will check if you have a previous WinPcap utility.

4. Click **OK**.

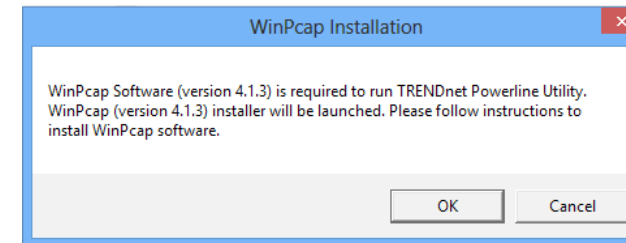

Note: The Powerline Utility requires WinPcap as a base application. If this prompt does not appear, you may already have the WinPcap application installed. Windows 8 require WinPcap 4.1.3. Windows 7 and older will work with previous versions of WinPcap. If you have installed a previous version of WinPcap, please uninstall it manually. And then, start the installation from the beginning.

5. At the WinPcap installer window, click **Next**.

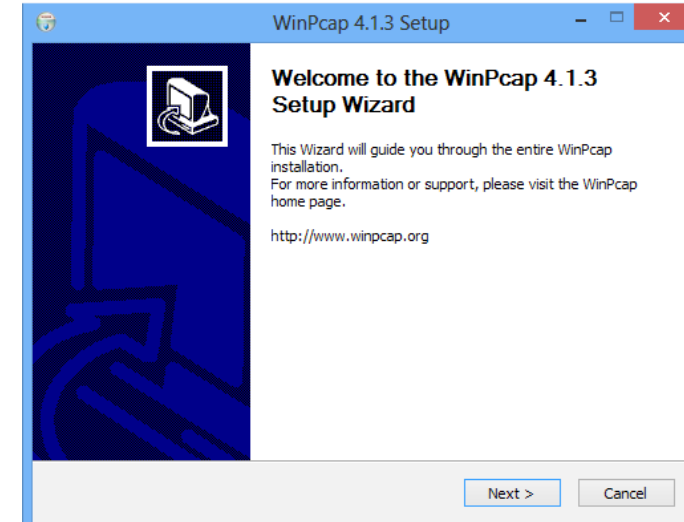

6. Click **Yes** to allow installation.

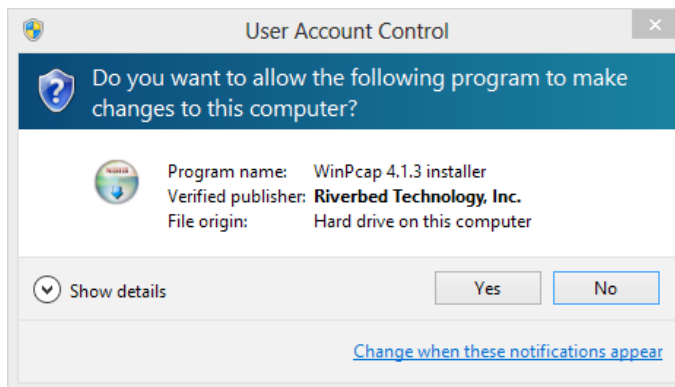

7. Review the license agreement and click **I Agree**.

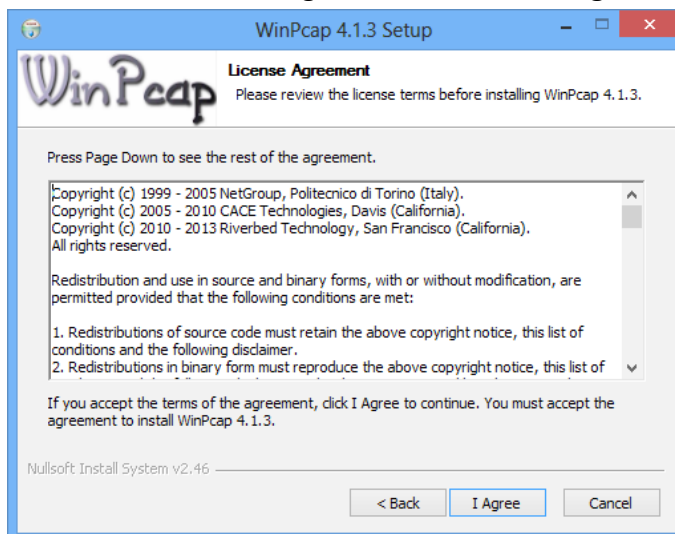

8. In the Installation Options window, leave the **Automatically start the WinPcap driver at boot time** checked and click **Install**.

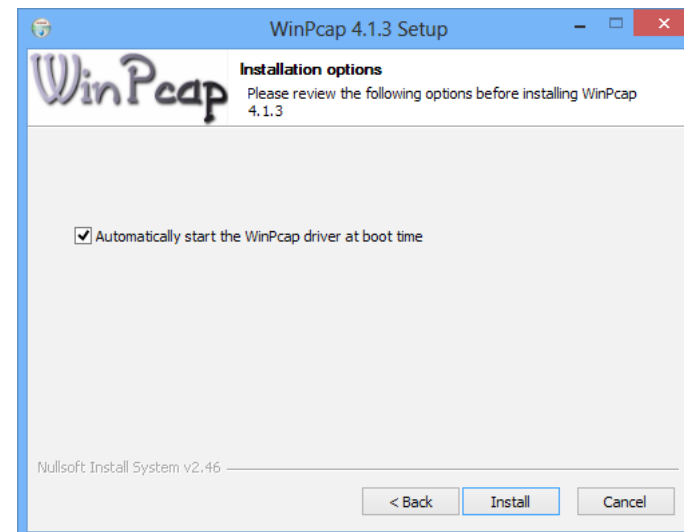

9. Wait for the WinPcap installation to complete.

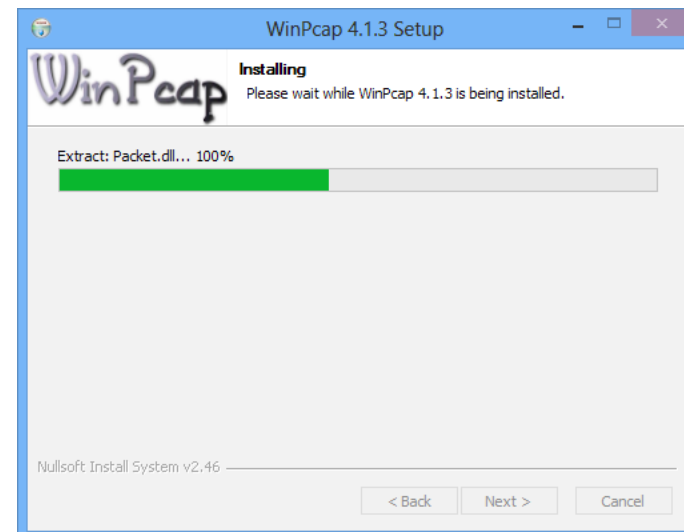

10. After the process has been completed, click **Finish**.

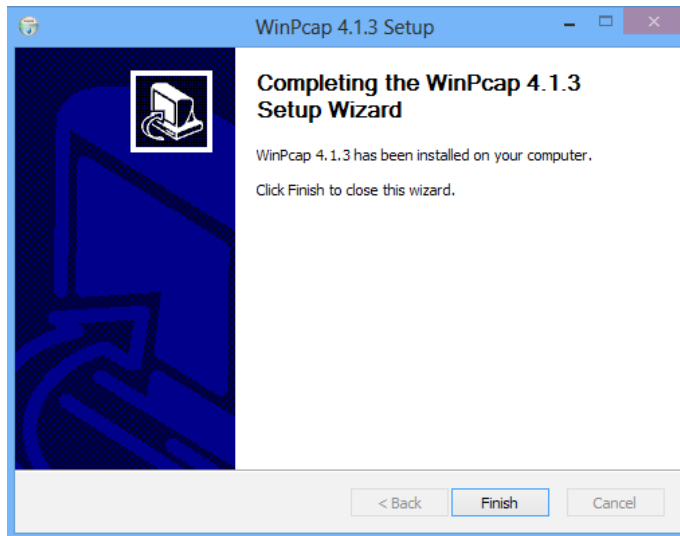

11. At the TRENDnet Powerline Utility Setup Wizard, click **Next**.

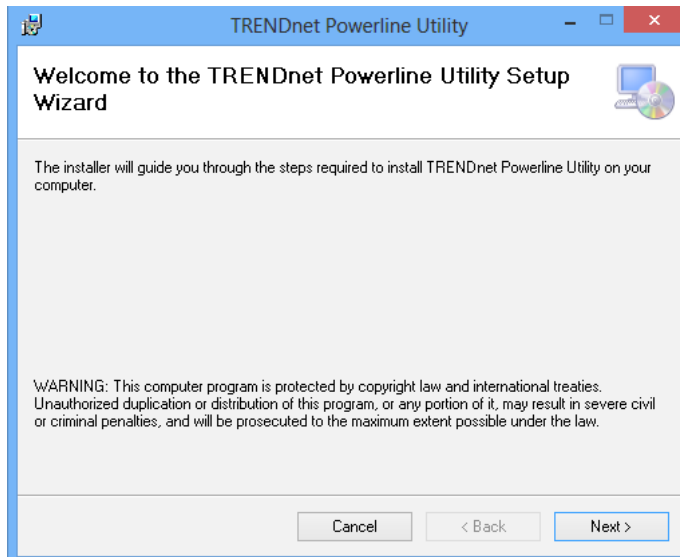

12. In the License Agreement window, click **I Agree**, and then click **Next**.

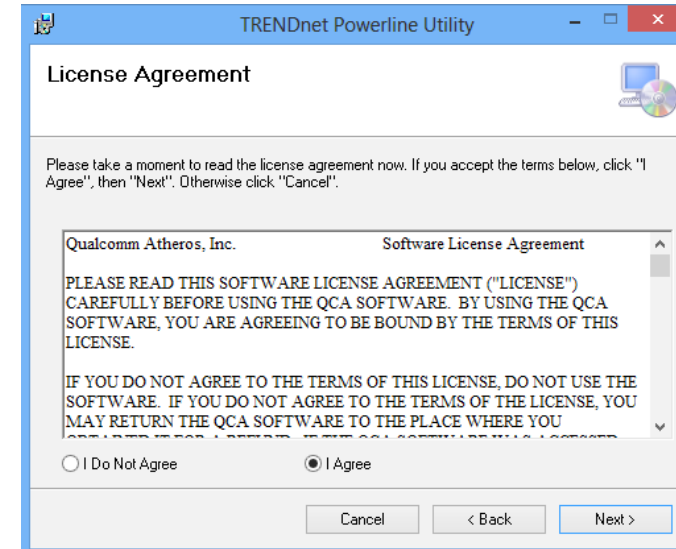

13. In the Select Installation Folder window, click **Next**.

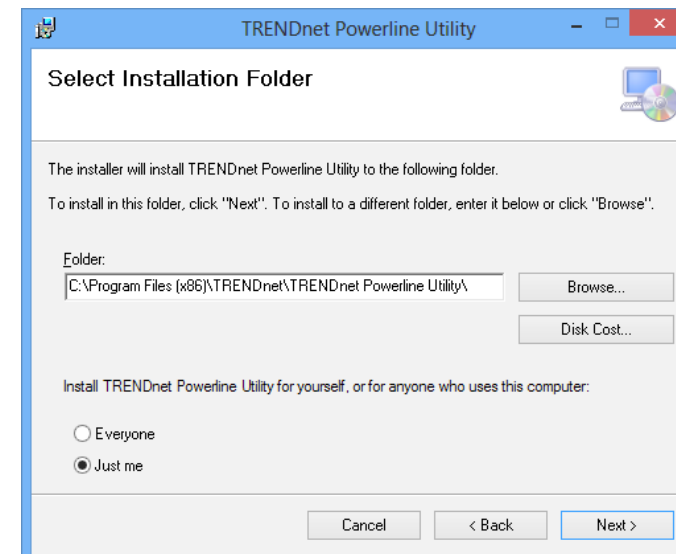

14. In the Confirm Installation window, click **Next**.

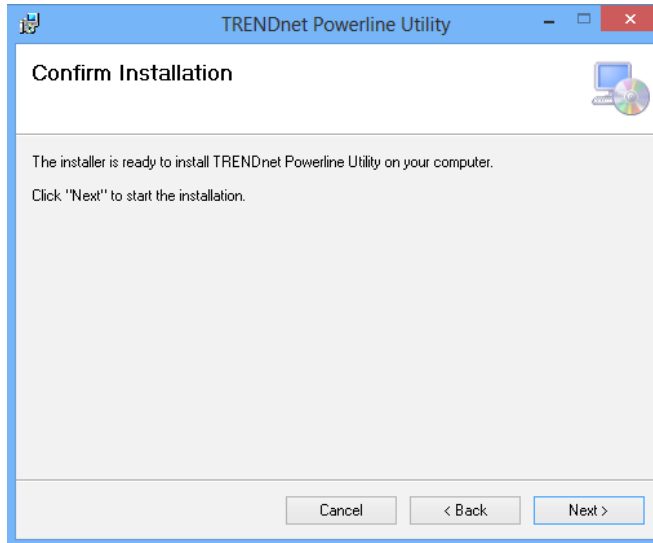

15. Wait for the Powerline Utility installation to complete. At the Installation Complete window, click **Close**.

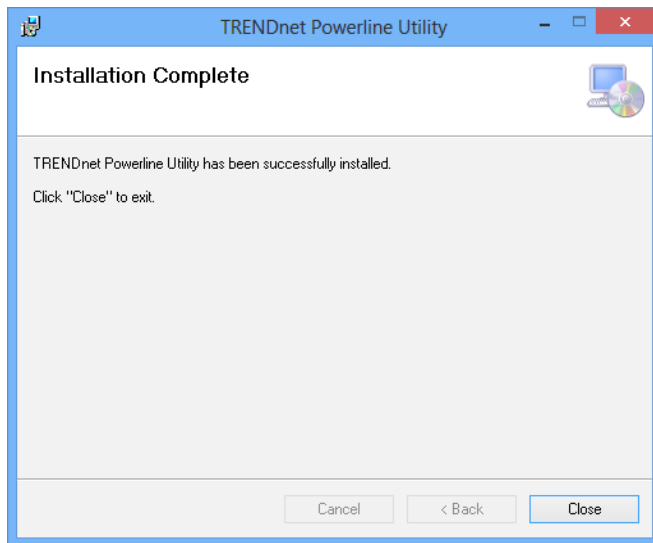

Using the Utility

Before using the utility, please ensure the following:

1. Write down the **Device Password (DPW)** (16-digit characters A-Z only) and **MAC Address** (12-digit characters a-f, A-F, 0-9) of each Powerline Adapter as this will be required to change the network name for multiple Powerline Adapters. See "Product information on device label" on page 2.
2. Make sure the computer in which you are installing the utility is connected to your network and your Powerline Adapters are also connected to your network.
3. If you have changed your network name using the **Sync** button and you are creating a customized network name, it is required to reset all powerline devices to defaults using the physical **Reset** button on your Powerline Adapter first before using the utility. See "Push Buttons" on page 3.
4. Please ensure that your Powerline Adapters are already installed and connected and the Ethernet port on each adapter is connected to a device powered on.

Upon completing the software installation, a desktop shortcut is automatically created. Double-click the icon to start the utility or open the utility if it is already running. Closing the utility will exit the application.

You can also launch the utility from Start Menu.
Start > Programs (or All Programs) > TRENDnet > TRENDnet Powerline Utility

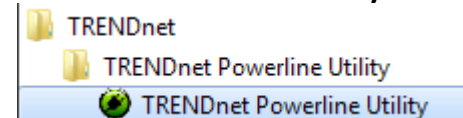

Powerline Utility - Map View

Local Device

All Powerline Adapters connected to the same network as your computer will be listed here.

The default device name is main chip number, followed by the MAC address and firmware version number. You can mouse over the header and adjust column width by clicking and dragging this cursor \updownarrow .

Remote Devices

These are Powerline Adapters in remote locations connected to a selected local Powerline Adapter on the electrical system.

You can mouse over the header and adjust the column width by clicking and dragging this cursor \updownarrow to see more information.

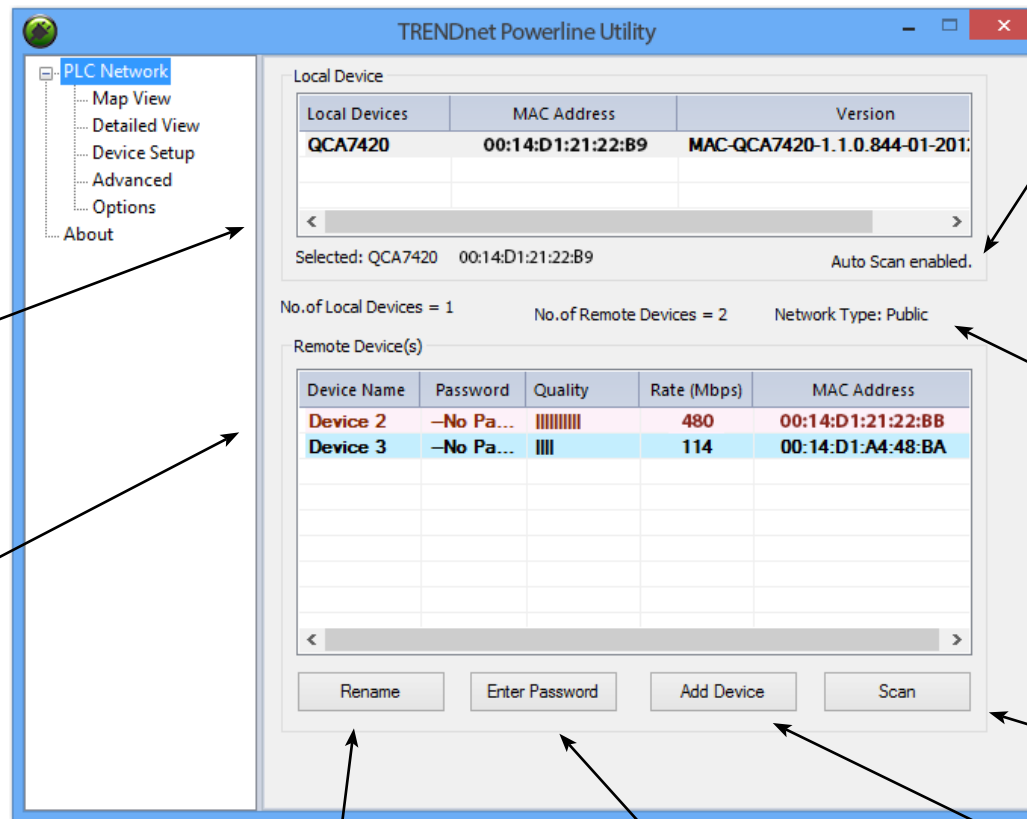

Auto Scan

Auto Scan is selected by default. The utility will scan for remote devices in specific intervals (default: 2 sec, you can change it from 2 to 60 secs). Auto scan can be disabled by deselecting it. Remote adapters can be scanned manually by clicking the **Scan** button below.

Network Type

The default network type is public. When the network name is customized and changed, it becomes private.

Manage your device

Highlight a device by clicking the row and click buttons below

Rename

Change device name to meaningful names such as "living room"

Enter Password

Enter device DPW here. You can manage the remote adapter if only you enter the DPW.

Scan

Manually scan remote Powerline devices which has same network name

Add Device

Add remote Powerline Adapter

* **DPW** (Device Password) is shown on device label

** TPL-4052E has a Power Save Mod. The device setting can only be changed when the device is active.

To keep remote Powerline Adapter in an active state, you can power cycle the device or connect it to a network device, such as a router or a computer.

Rename remote device

(Click and select a remote device and then click **Rename** button in Map View)

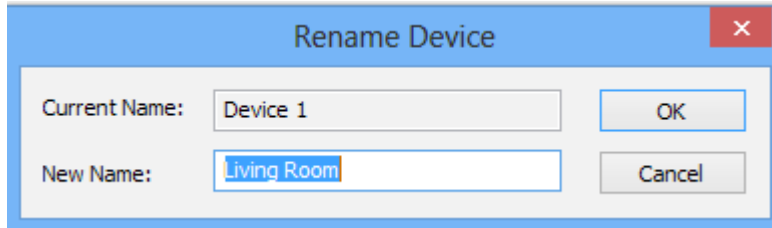

The screenshot shows a dialog box titled "Rename Device" with a close button (X) in the top right corner. It contains two text input fields: "Current Name:" with the value "Device 1" and "New Name:" with the value "Living Room". There are two buttons: "OK" and "Cancel".

Enter a meaningful name for easy management

Enter Password

(Click and select a remote device and then click **Enter Password** button in Map View)

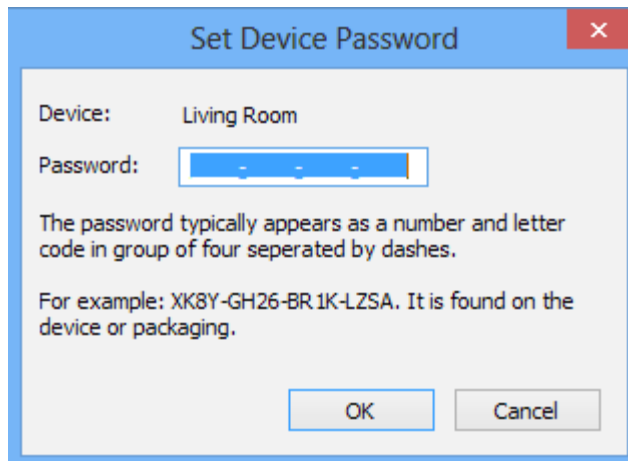

The screenshot shows a dialog box titled "Set Device Password" with a close button (X) in the top right corner. It contains two text input fields: "Device:" with the value "Living Room" and "Password:" which is empty. Below the fields, there is explanatory text: "The password typically appears as a number and letter code in group of four separated by dashes. For example: XK8Y-GH26-BR1K-LZSA. It is found on the device or packaging." At the bottom, there are "OK" and "Cancel" buttons.

The device password (DPW) can be found on device label. You have to enter DPW in order to manage Powerline Adapter remotely.

Add Device

(Click **Add Device** button in Map View)

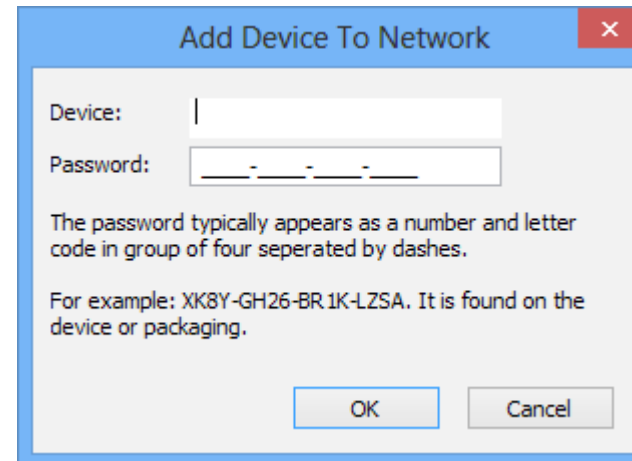

The screenshot shows a dialog box titled "Add Device To Network" with a close button (X) in the top right corner. It contains two text input fields: "Device:" which is empty and "Password:" which is empty. Below the fields, there is explanatory text: "The password typically appears as a number and letter code in group of four separated by dashes. For example: XK8Y-GH26-BR1K-LZSA. It is found on the device or packaging." At the bottom, there are "OK" and "Cancel" buttons.

Enter device name and DPW to add an adapter manually

Scan

Click **Scan** button in Map View to scan other powerline devices manually.

Powerline Utility - Detailed View

System Information

System Information section shows this utility version, your computer information, network adapters installed on your computer.

Remote Devices

Powerline Adapters in remote locations connect to your network shows here.

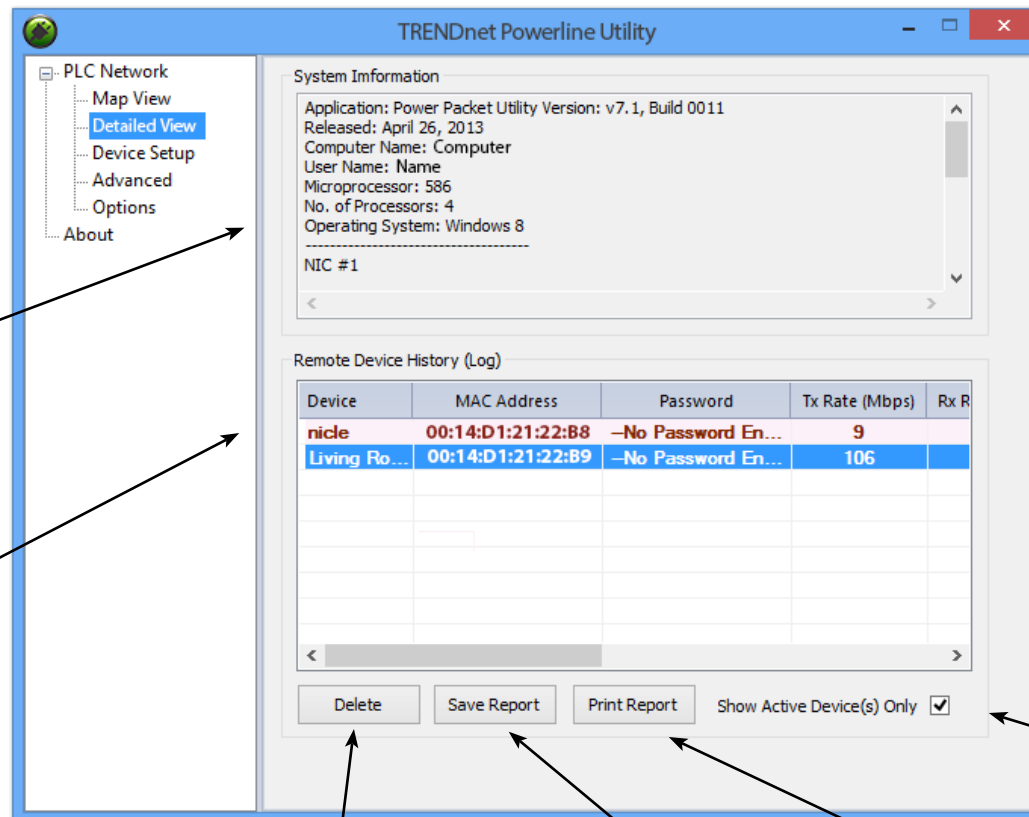

Manage your report

Highlight the device by clicking the row and click buttons below

Delete

Delete the device from status report (Un-select auto scan in About section to prevent the deleted device added in again.)

Save Report

Click this button to save above information for later use.

Print Report

Click this button sending above information to your default printer.

Show Active Device(s) Only

Un-check this check box, you can include all device information on network, even it is not in active state.

* DPW (Device Password) is shown on device label

Powerline Utility - Device Setup

Private Network Name

This is the network name of your powerline network. Default is "HomePlugAV". When network name set to "HomePlugAV", it is considered a public network because very out of box Powerline Adapter can join this network. Powerline Adapters connect to each other only when network name is the same. Change network name and make your network private is recommended to increase your privacy.

You have to remember your network name (Private Network Name). It will be encrypted and save to device. Even Powerline Utility cannot read it in plain text again. When you visit this Private Settings again and the Private Network Name show UnknownNetworkName, it means the network name is private.

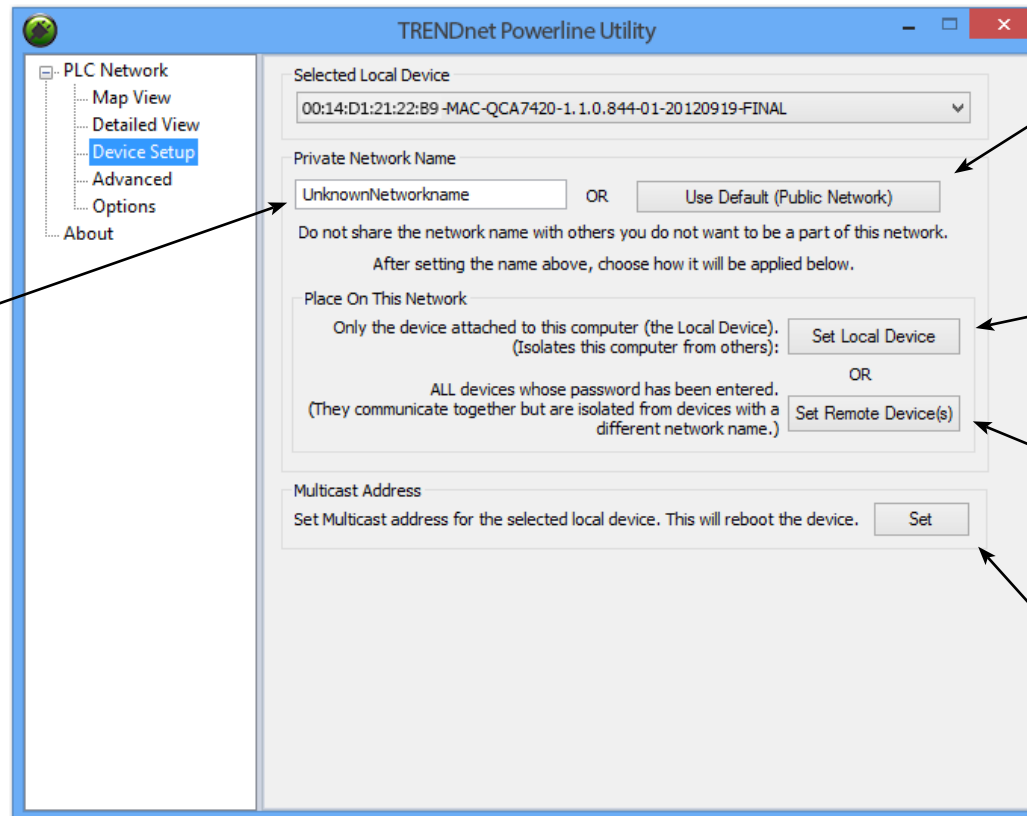

Use Default

If you don't remember what network name you set previously, you can set the network public. Then set it back to private later.

Set Local Device

Change network name on device selected above.

Set Remote Devices

All devices currently connected locally to your computer or connected remotely through powerline network will set to the new network name.

Multicast Address

Click this button to synchronize multicast address on all adapters on same powerline network.

Powerline Utility - Advanced

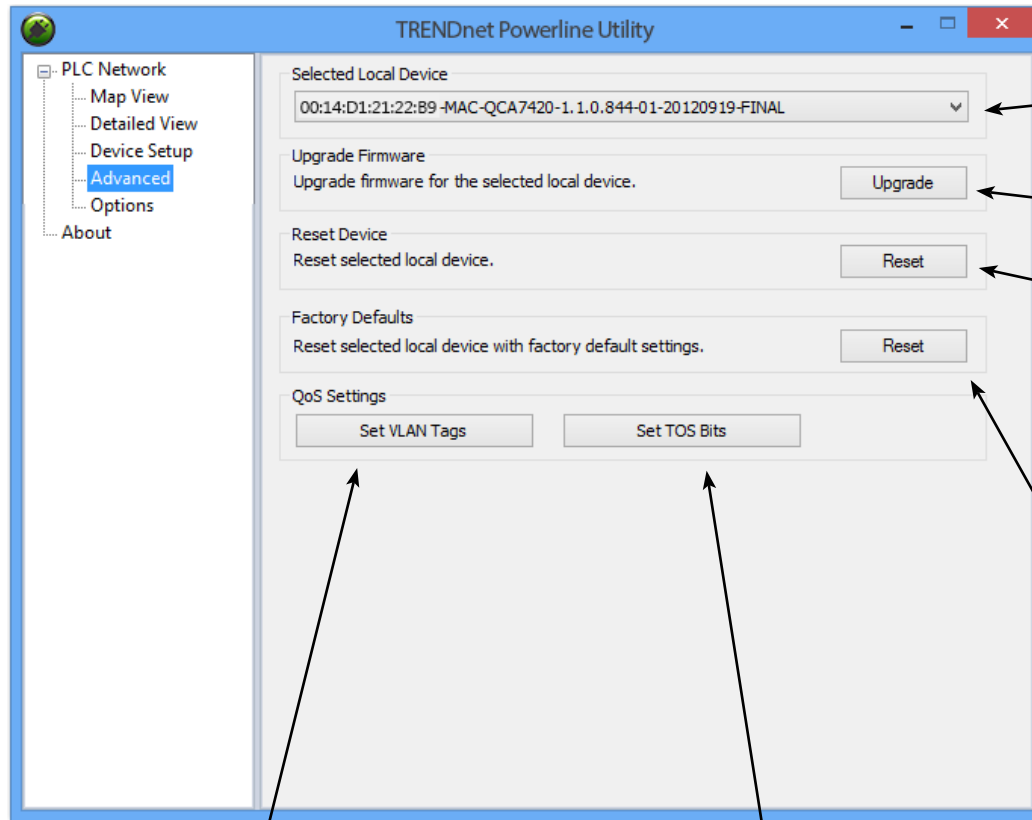

Select Local Device

This advanced feature supports local devices only. Choose one of your local device and proceed the advance setting.

Upgrade Firmware

Click this button to upgrade device firmware.

Reset Device

Cleanup device active jobs and start fresh again.

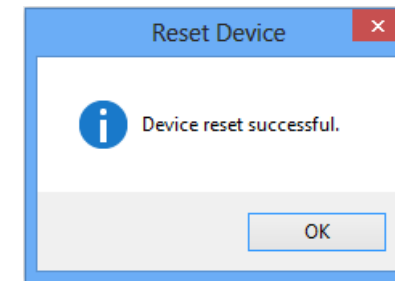

Factory Defaults

Clean up all your settings on adapter. Always click this button after you upgrade firmware.

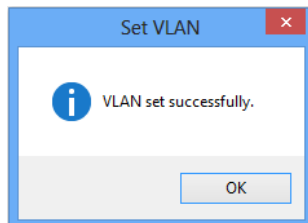
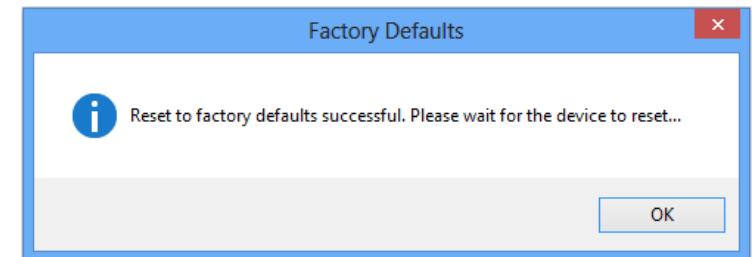

Set VLAN Tags

Set VLAN tag for stream identity

Set TOS Bits

Setup Type-of-Service bits to differentiate packets

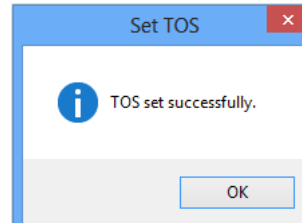

Powerline Utility - Options

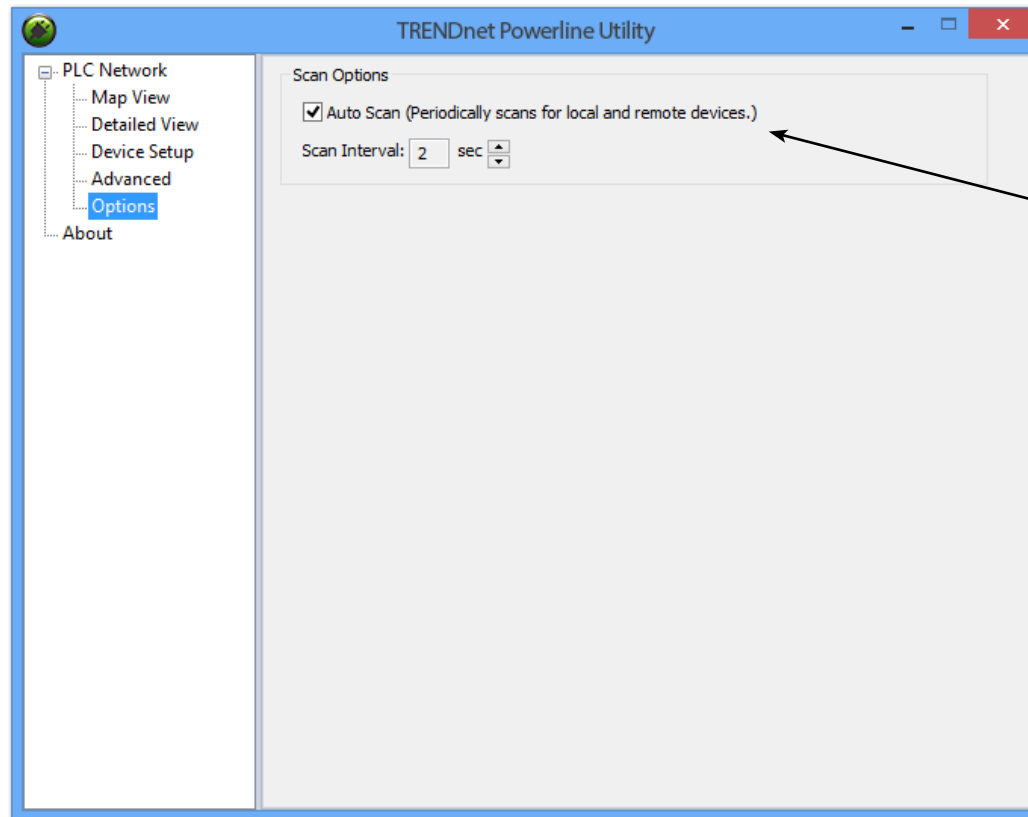

Scan Options

By default, the Powerline utility scans adapters attached to the network every 2 seconds. You can change the scanning frequency from 2 seconds up to 60 seconds or stop auto scan. You can then scan devices manually by clicking **Scan** button in **Map View**.

Powerline Utility - About

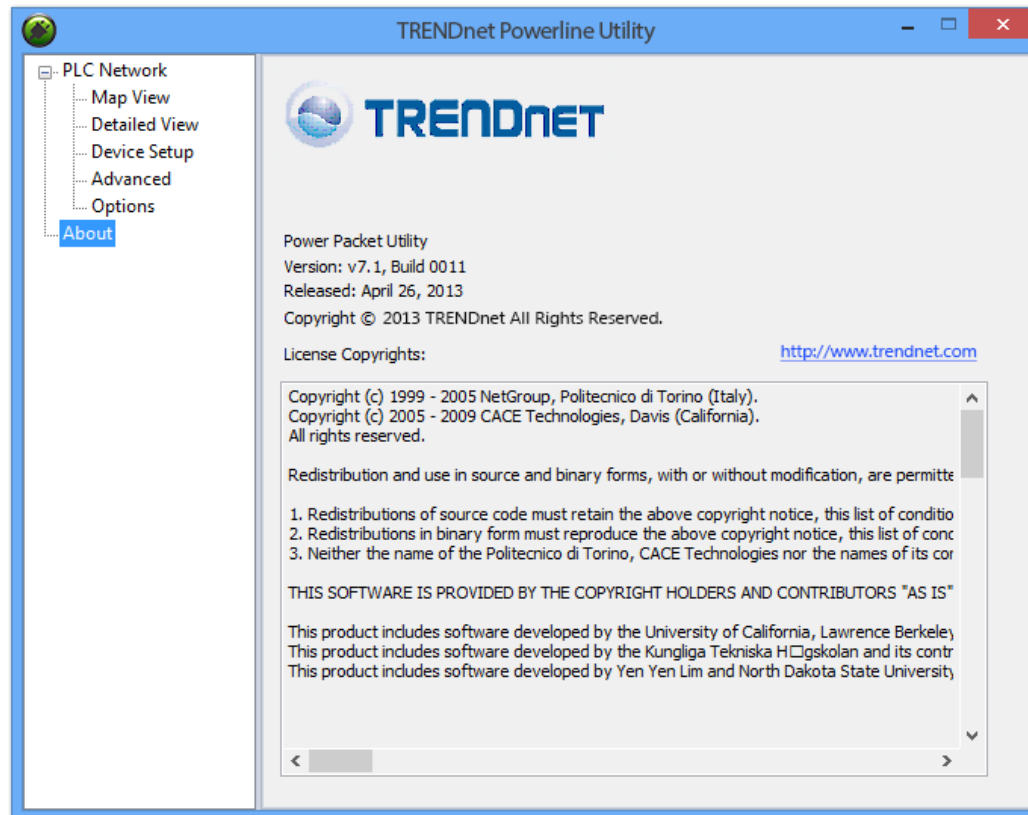

About Powerline Utility

This Powerline Utility manages TPL-4052E and most legacy HomePlug certified Powerline Adapters.

For more information, please visit our website www.trendnet.com

Technical Specifications

Standards	IEEE 1901, HomePlug® AV, IEEE 802.3, IEEE 802.3x, IEEE 802.3u
Interface	<ul style="list-style-type: none"> • 4 x 10/100 Mbps Fast Ethernet Auto-MDIX RJ-45 ports • Power plug <ul style="list-style-type: none"> ○ A: North America Type B (NEMA 5–15) ○ EU: Euro Type C (CEE 7/16) ○ UK : United Kingdom Type G (BS 1363)
Frequency Band	2 ~ 50 MHz
Modulation	OFDM Symbol Modulation on link synchronization, 1024/256/64/8 - QAM, QPSK, BPSK, ROBO Carrier
Protocol	TDMA, and CSMA/CA
Speed	Powerline: up to 500Mbps** Ethernet: up to 200Mbps with Full Duplex mode per port
Utility OS Compatibility	Windows 8 (32/64-bit), Windows 7 (32/64-bit), Vista (32/64-bit), XP(32/64-bit)
Nodes	Configuring up to 16 nodes Active nodes up to 8 nodes for simultaneous access
Coverage	Up to 300m (984ft.)
Security	128-Bit AES (Advanced Encryption Standard)

LED	Power (PWR) Powerline (PL) with Connection Quality Indication <ul style="list-style-type: none"> • Best (Green) • Better (Amber) • Good (Red) • No connection (Off) Fast Ethernet Connection (1-4) <ul style="list-style-type: none"> • Solid • Blinking • Off
Buttons	Sync, Reset
Dimension (L x W X H)	A: 105 x 75 x 57 mm (4.1 x 3.0 x 2.2 in.) EU: 105 x 75 x 73 mm (4.1 x 3.0 x 2.87 in.) UK: 105 x 75 x 65 mm (4.1 x 3.0 x 2.56 in.)
Weight	A: 147 g (5.2 oz) EU: 170 g (6.0 oz) UK: 159 g (5.6 oz)
Power Source	100~240V AC, 50~60Hz
Consumption	Active mode: 4 Watts (max.) Standby mode: 0.5 Watts (max.)
Temperature	Operating: 0° ~ 40°C (32° ~ 104°F) Storage: -20° ~ 70°C (-4° ~ 158°F)
Humidity	Max. 90% (non-condensing)
Certifications	CE, FCC, HomePlug® AV

* 8 active adapter can stream data at the same time. You can configure up to 16 adapters in the same network. Additional adapters may decrease network performance. 500Mbps is the maximum theoretical Powerline data rate. Actual throughput will vary depending on environment. Networked Powerline devices need to be plugged into power outlets that are on the same electrical system. GFCI outlets and AFCI circuit breakers may degrade powerline network signals.

Troubleshooting

Please reference the items below if you continue to experience difficulty with installing and using your Powerline Adapters.

- Power-cycle the Powerline Adapters by disconnecting them from their power outlets for 15 seconds and then reconnect them.
- If the Powerline (PL) LED is red, try plugging the Powerline Adapter into another available power outlet. The quality of the connection may be better in a different power outlet.
- If you are having issues connecting the Powerline Adapters after changing the network name using the Sync button or Powerline utility, reset the Powerline Adapters to defaults using the physical Reset button.
- Using a pin or paperclip; press and hold the Reset button for 1 second on each Powerline Adapter. All LEDs will turn off then turn back on. This will reset the Powerline Adapters to their default settings. The default network name is HomePlugAV.
- The Powerline Adapters can provide better connectivity and performance when plugged directly into a power outlet. Connecting the Powerline Adapters to a power strip or surge protector may degrade or block Powerline signals.
- Avoid using the Powerline Adapters on GFI protected outlets and electrical systems with AFCI circuit breakers. They may degrade or block powerline signals.
- The Powerline Adapters should not be used in areas with excessive heat.
- Florescent and incandescent lighting can generate significant powerline interference.
- If your building has more than one circuit breaker box, the Powerline Adapter may not be able to establish connectivity between them. In this case, connect a Powerline Adapter into a power outlet located on each of the circuit breaker boxes. Then connect an Ethernet cable between the Powerline Adapters to bridge the two circuits together.

In addition to this User's Guide, you can find help below:

- <http://www.trendnet.com/support>
(documentation, downloads, FAQs, how to contact technical support)
- Autorun CD (Quick Installation Guide)

Appendix

Overlapping powerline networks

It is possible to create multiple powerline networks on the same electrical system separated and grouped by different network names. The powerline networks will work and communicate independently of each other which can provide security between different groups of Powerline Adapters. For example, if you have five Powerline Adapters (Adapter A, Adapter B, Adapter C, Adapter D, Adapter E), you can group Adapters A, B, and C together on one powerline network and group Adapters D and E on a different powerline network. Each group will use a different network name.

Note: It is recommended that only a maximum of up to 4 powerline networks can be created per electrical system. Any additional powerline networks above the recommended may result in significant degradation in powerline performance.

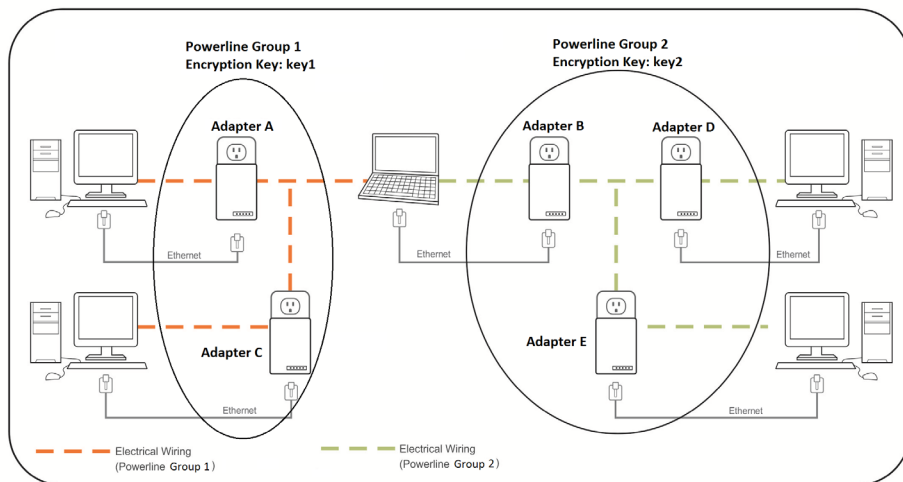

Move Powerline Adapters between different overlapping powerline networks

Note: Assuming all Powerline Adapters are TRENDnet Powerline Adapters and for reference in the diagram and this procedure, the adapters will be labeled **Adapter A, B, C, D, and E**. **Adapters A, B, and C** are currently connect together to form one powerline network and **Adapters D and E** form another powerline network. **Adapter B** will be disconnected from **Adapters A and C** and connected to **Adapters D and E**.

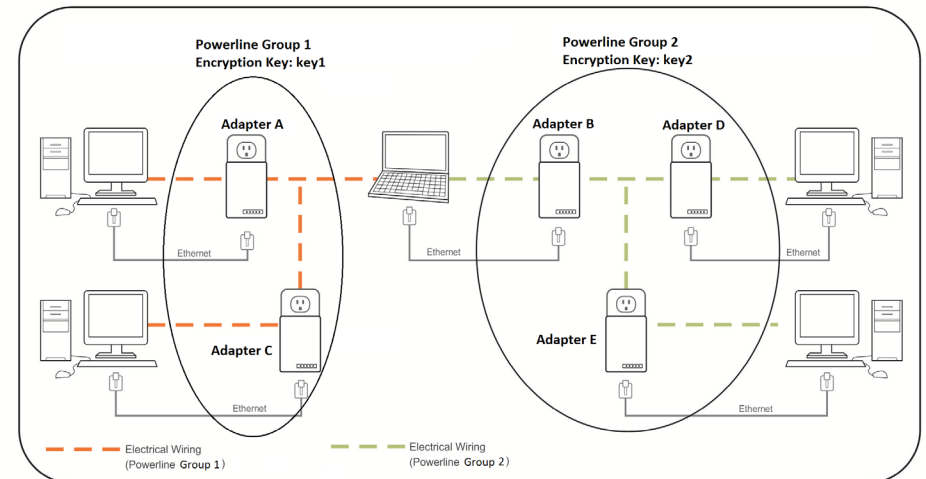

1. Push and hold the Sync button on **Adapter B** for 15 seconds and release it. All LEDs will turn off and turn back on. This will erase the current network name assigned to **Adapter B** and disconnect from **Adapter A** and **Adapter C**.
2. Push and hold the **Sync** button on **Adapter D** for 2 seconds and release it. The **Power (PWR)** LED will start blinking.

3. Within 2 minutes, push and hold the **Sync** button on **Adapter B** for 2 seconds and release it. The **Power (PWR) LED** will start blinking. This will establish connectivity between **Adapter B**, **Adapter D**, and **Adapter E** by reconfiguring the network name of **Adapter B** to match the network name of **Adapter D** and **Adapter E**. All LEDs will turn off and turn back on and the **Powerline (PL) LED** will turn on the when adapters are connected.

Federal Communication Commission Interference Statement

This equipment has been tested and found to comply with the limits for a Class B digital device, pursuant to Part 15 of the FCC Rules. These limits are designed to provide reasonable protection against harmful interference in a residential installation. This equipment generates uses and can radiate radio frequency energy and, if not installed and used in accordance with the instructions, may cause harmful interference to radio communications. However, there is no guarantee that interference will not occur in a particular installation. If this equipment does cause harmful interference to radio or television reception, which can be determined by turning the equipment off and on, the user is encouraged to try to correct the interference by one of the following measures:

- Reorient or relocate the receiving antenna.
- Increase the separation between the equipment and receiver.
- Connect the equipment into an outlet on a circuit different from that to which the receiver is connected.
- Consult the dealer or an experienced radio/TV technician for help.

FCC Caution: Any changes or modifications not expressly approved by the party responsible for compliance could void the user's authority to operate this equipment.

This device complies with Part 15 of the FCC Rules. Operation is subject to the following two conditions: (1) This device may not cause harmful interference, and (2) this device must accept any interference received, including interference that may cause undesired operation.

**IMPORTANT NOTE:****FCC Radiation Exposure Statement:**

This equipment complies with FCC radiation exposure limits set forth for an uncontrolled environment. This equipment should be installed and operated with minimum distance 20cm between the radiator & your body.

This transmitter must not be co-located or operating in conjunction with any other antenna or transmitter.

The availability of some specific channels and/or operational frequency bands are country dependent and are firmware programmed at the factory to match the intended destination. The firmware setting is not accessible by the end user.

RoHS

This product is RoHS compliant.











**Europe – EU Declaration of Conformity**









This device complies with the essential requirements of the Directive 2004/108/EC, /2006/95/EC and 2009/125/EC:

EN55022 : 2010, class B
 EN 61000-6-3 : 2007 + A1 :2011
 EN 61000-3-2 : 20086 + A1 : 2009 + A2 : 2009,
 class A
 EN 61000-3-3 : 2008
 EN 50412-2-1 :2005, class 1, type 2

EN 60950-1 :2006 + A11 : 2009 + A1 : 2010 + A2 : 2011 : Safety of Information Technology Equipment including electrical business equipment



 Český [Czech]	TRENDnet tímto prohlašuje, že tento TPL-4052E je ve shodě se základními požadavky a dalšími příslušnými ustanoveními směrnice 2004/108/ES.
 Dansk [Danish]	Undertegnede TRENDnet erklærer herved, at følgende udstyr TPL-4052E overholder de væsentlige krav og øvrige relevante krav i direktiv 2004/108/EF.
 Deutsch [German]	Hiermit erklärt TRENDnet, dass sich das Gerät TPL-4052E in Übereinstimmung mit den grundlegenden Anforderungen und den übrigen einschlägigen Bestimmungen der Richtlinie 2004/108/EG befindet.
 Eesti [Estonian]	Käesolevaga kinnitab TRENDnet seadme TPL-4052E vastavust direktiivi 2004/108/EÜ põhinõuetele ja nimetatud direktiivist tulenevatele teistele asjakohastele sätetele.
 English	Hereby, TRENDnet, declares that this TPL-4052E is in compliance with the essential requirements and other relevant provisions of Directive 2004/108/EC.
 Español [Spanish]	Por medio de la presente TRENDnet declara que el TPL-4052E cumple con los requisitos esenciales y cualesquiera otras disposiciones aplicables o exigibles de la Directiva 2004/108/CE.
 Ελληνική [Greek]	ΜΕ ΤΗΝ ΠΑΡΟΥΣΑ TRENDnet ΔΗΛΩΝΕΙ ΟΤΙ ΤΡΡ-4052Ε ΣΥΜΜΟΡΦΩΝΕΤΑΙ ΠΡΟΣ ΤΙΣ ΟΥΣΙΩΔΕΙΣ ΑΠΑΙΤΗΣΕΙΣ ΚΑΙ ΤΙΣ ΛΟΙΠΕΣ ΣΧΕΤΙΚΕΣ ΔΙΑΤΑΞΕΙΣ ΤΗΣ ΟΔΗΓΙΑΣ 2004/108/ΕΚ.
 Français [French]	Par la présente TRENDnet déclare que l'appareil TPL-4052E est conforme aux exigences essentielles et aux autres dispositions pertinentes de la directive 2004/108/CE.
 Italiano [Italian]	Con la presente TRENDnet dichiara che questo TPL-4052E è conforme ai requisiti essenziali ed alle altre disposizioni pertinenti stabilite dalla direttiva 2004/108/CE.
 Latvīski [Latvian]	Ar šo TRENDnet deklarē, ka TPL-4052E atbilst Direktīvas 2004/108/EK būtiskajām prasībām un citiem ar to saistītajiem noteikumiem.
 Lietuvių [Lithuanian]	Šiuo TRENDnet deklaruoja, kad šis TPL-4052E atitinka esminius reikalavimus ir kitas 2004/108/EB Direktyvos nuostatas.

 Nederlands [Dutch]	Hierbij verklaart TRENDnet dat het toestel TPL-4052E in overeenstemming is met de essentiële eisen en de andere relevante bepalingen van richtlijn 2004/108/EG.
 Malti [Maltese]	Hawnhekk, TRENDnet, jiddikjara li dan TPL-4052E jikkonforma mal-ħtiġijiet essenzjali u ma provvedimenti oħrajn relevanti li hemm fid-Dirrettiva 2004/108/EC.
 Magyar [Hungarian]	Alulírott, TRENDnet nyilatkozom, hogy a TPL-4052E megfelel a vonatkozó alapvető követelményeknek és az 2004/108/EC irányelv egyéb előírásainak.
 Polski [Polish]	Niniejszym TRENDnet oświadcza, że TPL-4052E jest zgodny z zasadniczymi wymogami oraz pozostałymi stosownymi postanowieniami Dyrektywy 2004/108/EC.
 Português [Portuguese]	TRENDnet declara que este TPL-4052E está conforme com os requisitos essenciais e outras disposições da Directiva 2004/108/CE.
 Slovensko [Slovenian]	TRENDnet izjavlja, da je ta TPL-4052E v skladu z bistvenimi zahtevami in ostalimi relevantnimi določili direktive 2004/108/ES.
 Slovenský [Slovak]	TRENDnet týmto vyhlasuje, že TPL-4052E spĺňa základné požiadavky a všetky príslušné ustanovenia Smernice 2004/108/ES.
 Suomi [Finnish]	TRENDnet vakuuttaa täten että TPL-4052E tyyppinen laite on direktiivin 2004/108/EY oleellisten vaatimusten ja sitä koskevien direktiivin muiden ehtojen mukainen.
 Svenska [Swedish]	Härmed intygar TRENDnet att denna TPL-4052E står i överensstämmelse med de väsentliga egenskapskrav och övriga relevanta bestämmelser som framgår av direktiv 2004/108/EG.

Limited Warranty

TRENDnet warrants its products against defects in material and workmanship, under normal use and service, for the following lengths of time from the date of purchase.

- TPL-4052E – 3 Years Warranty
- AC/DC Power Adapter, Cooling Fan, and Power Supply carry 1 year warranty.

If a product does not operate as warranted during the applicable warranty period, TRENDnet shall reserve the right, at its expense, to repair or replace the defective product or part and deliver an equivalent product or part to the customer. The repair/replacement unit's warranty continues from the original date of purchase. All products that are replaced become the property of TRENDnet. Replacement products may be new or reconditioned. TRENDnet does not issue refunds or credit. Please contact the point-of-purchase for their return policies.

TRENDnet shall not be responsible for any software, firmware, information, or memory data of customer contained in, stored on, or integrated with any products returned to TRENDnet pursuant to any warranty.

There are no user serviceable parts inside the product. Do not remove or attempt to service the product by any unauthorized service center. This warranty is voided if (i) the product has been modified or repaired by any unauthorized service center, (ii) the product was subject to accident, abuse, or improper use (iii) the product was subject to conditions more severe than those specified in the manual.

Warranty service may be obtained by contacting TRENDnet within the applicable warranty period and providing a copy of the dated proof of the purchase. Upon proper submission of required documentation a Return Material Authorization (RMA) number will be issued. An RMA number is required in order to initiate warranty service support for all TRENDnet products. Products that are sent to TRENDnet for RMA service must have the RMA number marked on the outside of return packages and sent to TRENDnet prepaid, insured and packaged appropriately for safe shipment. Customers shipping from outside of the USA and Canada are responsible for return shipping fees. Customers shipping from outside of the USA are responsible for custom charges, including but not limited to, duty, tax, and other fees.

WARRANTIES EXCLUSIVE: IF THE TRENDNET PRODUCT DOES NOT OPERATE AS WARRANTED ABOVE, THE CUSTOMER'S SOLE REMEDY SHALL BE, AT TRENDNET'S OPTION, REPAIR OR REPLACE. THE FOREGOING WARRANTIES AND REMEDIES ARE EXCLUSIVE AND ARE IN LIEU OF ALL OTHER WARRANTIES, EXPRESSED OR IMPLIED, EITHER IN FACT OR BY OPERATION OF LAW, STATUTORY OR OTHERWISE, INCLUDING WARRANTIES OF MERCHANTABILITY AND FITNESS FOR A PARTICULAR PURPOSE. TRENDNET NEITHER ASSUMES NOR AUTHORIZES ANY OTHER PERSON TO ASSUME

FOR IT ANY OTHER LIABILITY IN CONNECTION WITH THE SALE, INSTALLATION MAINTENANCE OR USE OF TRENDNET'S PRODUCTS.

TRENDNET SHALL NOT BE LIABLE UNDER THIS WARRANTY IF ITS TESTING AND EXAMINATION DISCLOSE THAT THE ALLEGED DEFECT IN THE PRODUCT DOES NOT EXIST OR WAS CAUSED BY CUSTOMER'S OR ANY THIRD PERSON'S MISUSE, NEGLIGENCE, IMPROPER INSTALLATION OR TESTING, UNAUTHORIZED ATTEMPTS TO REPAIR OR MODIFY, OR ANY OTHER CAUSE BEYOND THE RANGE OF THE INTENDED USE, OR BY ACCIDENT, FIRE, LIGHTNING, OR OTHER HAZARD.

LIMITATION OF LIABILITY: TO THE FULL EXTENT ALLOWED BY LAW TRENDNET ALSO EXCLUDES FOR ITSELF AND ITS SUPPLIERS ANY LIABILITY, WHETHER BASED IN CONTRACT OR TORT (INCLUDING NEGLIGENCE), FOR INCIDENTAL, CONSEQUENTIAL, INDIRECT, SPECIAL, OR PUNITIVE DAMAGES OF ANY KIND, OR FOR LOSS OF REVENUE OR PROFITS, LOSS OF BUSINESS, LOSS OF INFORMATION OR DATE, OR OTHER FINANCIAL LOSS ARISING OUT OF OR IN CONNECTION WITH THE SALE, INSTALLATION, MAINTENANCE, USE, PERFORMANCE, FAILURE, OR INTERRUPTION OF THE POSSIBILITY OF SUCH DAMAGES, AND LIMITS ITS LIABILITY TO REPAIR, REPLACEMENT, OR REFUND OF THE PURCHASE PRICE PAID, AT TRENDNET'S OPTION. THIS DISCLAIMER OF LIABILITY FOR DAMAGES WILL NOT BE AFFECTED IF ANY REMEDY PROVIDED HEREIN SHALL FAIL OF ITS ESSENTIAL PURPOSE.

Governing Law: This Limited Warranty shall be governed by the laws of the state of California.

Some TRENDnet products include software code written by third party developers. These codes are subject to the GNU General Public License ("GPL") or GNU Lesser General Public License ("LGPL").

Go to <http://www.trendnet.com/gpl> or <http://www.trendnet.com> Download section and look for the desired TRENDnet product to access to the GPL Code or LGPL Code. These codes are distributed WITHOUT WARRANTY and are subject to the copyrights of the developers. TRENDnet does not provide technical support for these codes. Please go to <http://www.gnu.org/licenses/gpl.txt> or <http://www.gnu.org/licenses/lgpl.txt> for specific terms of each license.



Product Warranty Registration

Please take a moment to register your product online.
Go to TRENDnet's website at <http://www.trendnet.com/register>

TRENDnet
20675 Manhattan Place
Torrance, CA 90501. USA