



User's Guide

TPL-402E
TPL-402E2K
1.01

Table of Contents

Chapter 1: Product Overview	3
1.1 Powerline Network Solution	3
1.2 Package Contents	4
1.3 System Requirements	4
1.4 Device Label	5
1.5 LEDs.....	5
1.6 Ethernet Port/Buttons.....	7
Chapter 2: Product Installation	8
2.1 Initial Installation.....	9
2.2 Securing your Powerline Network.....	10
2.3 Changing the Network Name/Security Key using the Sync Button.....	11
2.4 Adding the Powerline Adapter to an Existing Powerline Network	12
Chapter 3: Overlapping Powerline Networks	13
3.1 Move Powerline Adapters between different Powerline Networks	14
Chapter 4: Powerline Configuration Utility	15
4.1 Software Installation.....	15
4.2 Using the Utility	20
Chapter 5: Troubleshooting	23
Chapter 6: Specifications	25

Chapter 1: Product Overview

The TPL-402E / TPL-402E2K is an excellent solution that can be used to extend your network using your home or small office electrical wiring. In a home or small office building, use the 500Mbps Powerline AV Adapter with Bonus Outlet to link multiple locations without the need to run long Ethernet cables. Combined with a single broadband DSL/Cable Internet connection, every room with electrical power outlets can provide easy access to your high-speed Internet connection. With HomePlug® AV speeds of up to 500Mbps, this easy-to-setup solution can provide fast streaming HD movies, online multiplayer games, and other data intensive applications for today's HD Entertainment Center demand.

Each TPL-402E 500Mbps Powerline AV Adapter with Bonus Outlet allows you to connect one network enabled device to a powerline network via Ethernet. In addition, the built-in electrical power socket provides an additional outlet with noise filter to ensure optimum connection speeds and performance when using devices that need to be plugged into the electrical outlet. In operation, the 500Mbps Powerline AV Adapter with Bonus Outlet is completely transparent, and simply passes data between the Ethernet port and the powerline network. Any Ethernet-enabled device may be connected to the 10/100/1000Mbps Auto-MDIX Gigabit Ethernet port.

1.1 Powerline Network Solution

Add high-speed Internet access to any room in your home with this 500Mbps Powerline AV Adapter with Bonus Outlet. You can stream HD movies and music, play online multiplayer games and much more.

Note: This TPL-402E 500Mbps Powerline AV Adapter with Bonus Outlet needs to pair with at least one other IEEE 1901 or HomePlug® AV compatible powerline device. (e.g. TRENDnet Powerline AV products TPL-305E, TPL-303E, TPL-304E, TPL-310AP, TPL-401E, or another TPL-402E). The TPL-402E2K 500Mbps Powerline AV Adapter Kit with Bonus Outlet already includes two TPL-402E adapters, therefore, there is no requirement for an additional powerline adapter.

1.2 Package Contents

The product package should contain the following items:

TPL-402E 500Mbps Powerline AV Adapter with Bonus Outlet

- TPL-402E
- Multi-Language Quick Installation Guide
- CD-ROM (Utility & User's Guide)
- Network Cable (1.5 m / 5 ft.)

TPL-402E2K 500Mbps Powerline AV Adapter Kit with Bonus Outlet

- 2 x TPL-402E
- Multi-Language Quick Installation Guide
- CD-ROM (Utility & User's Guide)
- 2 x network cables (1.5 m / 5 ft.)

If any of the parts are incorrect, missing, or damaged, contact your dealer. Keep the carton, including the original packaging materials, in case you need to return the Powerline adapter for repair.

1.3 System Requirements

- CD-ROM drive
- A Desktop or Laptop PC with Network Adapter Installed
- Existing 10/100/1000Mbps wired network when TPL-402E is used as a bridge device
- Additional HomePlug® AV or IEEE 1901 compliant powerline adapter

Note: Requirement for TPL-402E only, (e.g. TRENDnet TPL-303E, TPL-304E, TPL-310AP, TPL-305E, TPL-401E, or another TPL-402E) The TPL-402E2K already includes two TPL-402E adapters.

Powerline Configuration Utility System Requirements

Supported Operating Systems	CPU	Memory
Windows 7 (32/64-bit)	1GHz or above	1GB RAM or above
Windows Vista (32/64-bit)	800MHz or above	512MB RAM or above
Windows XP (32/64-bit)	300MHz or above	256MB RAM or above

1.4 Device Label

The device label can be located on the back of the device where the power prong is found.

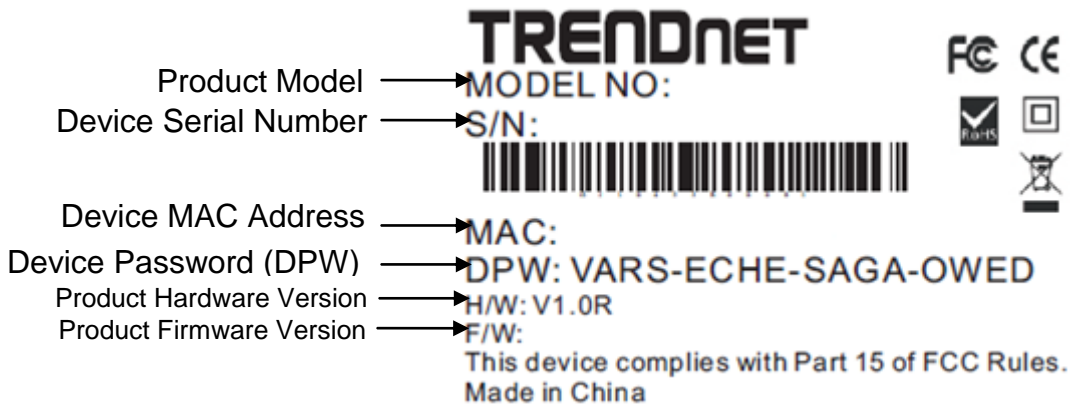

1.5 LEDs

The LED panel located on the front of the device consists of the status LEDs: Power (PWR), Powerline (PL), and Ethernet Link/Act (ETH).

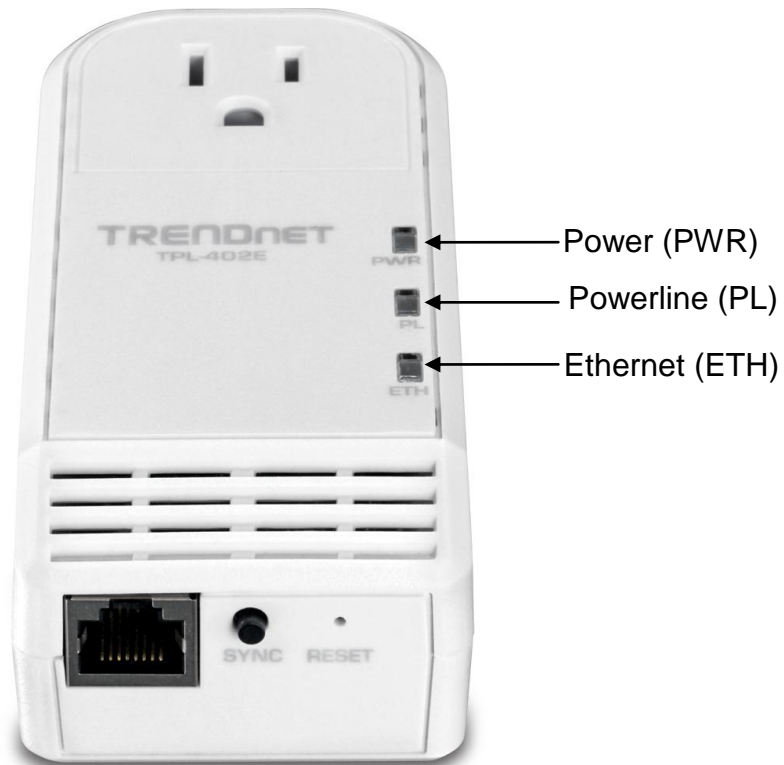

LED	Color	Sequence	Definition
PWR (Power)	Green	Solid	Device powered On
	N/A	Off	Device powered Off
PL (Powerline) Note: LED color indicates the strength and quality of the powerline connection through the electrical system	Green	Solid	Powerline Connected (Connection Quality is Best)
		Blinking	Syncing or Powerline Data Transmitting/Receiving (Connection Quality is Best)
	Amber	Solid	Powerline Connected (Connection Quality is Better)
		Blinking	Powerline Data Transmitting/Receiving (Connection Quality is Better)
	Red	Solid	Powerline Connected (Connection Quality is Good)
		Blinking	Powerline Data Transmitting/Receiving (Connection Quality is Good)
	N/A	Off	Powerline is not synced or connected
ETH (Ethernet Port)	Green	Solid	10/20 Mbps, 100/200Mbps, or 1000/2000Mbps (Half/Full Duplex) Connected
		Blinking	10/20Mbps, 100/200Mbps, or 1000/2000Mbps (Half/Full Duplex) Data Transmitting/Receiving
	N/A	Off	Port Disconnected/No Ethernet Link

*Note: The following factors may affect the powerline network's connection quality:

- Noise – Generated by appliances that are connected to your electrical system through power outlets that have high power consumption requirements. (e.g. Microwaves, ovens, blow dryer, iron, dishwasher, etc.) The quality of your household electrical wiring may also cause additional noise on your electrical system.
- Distance – Long lengths of electrical wiring through your electrical system between connected powerline adapters.

1.6 Ethernet Port/Buttons

There is one RJ-45 10/100/1000Mbps Auto-MDIX Gigabit Ethernet port, Reset Button, and Sync Button located at the bottom of the device.

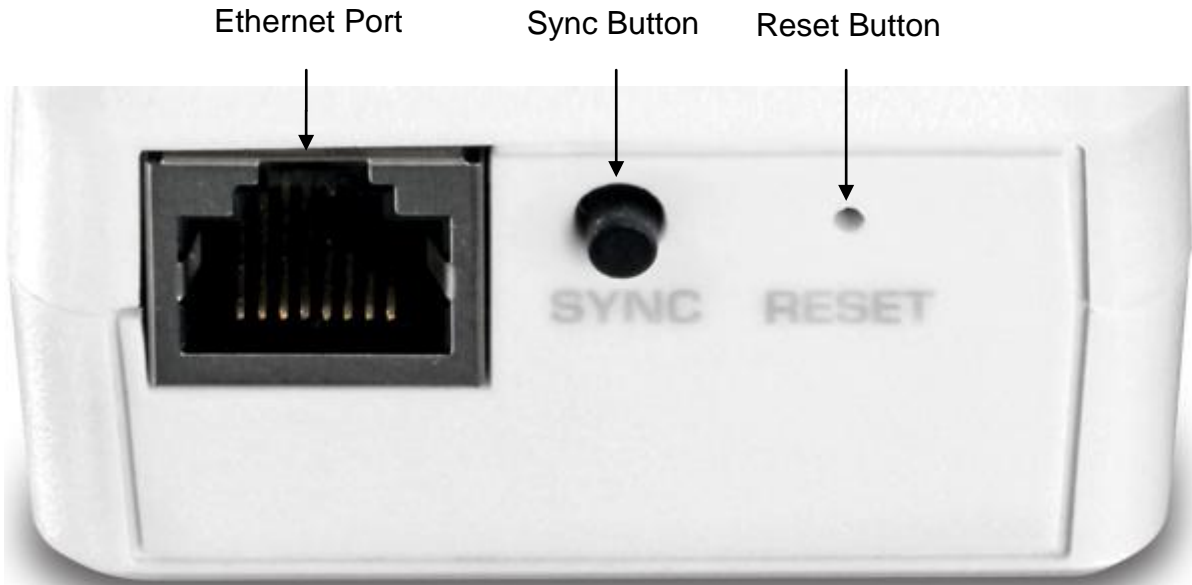

Button	Action	Function
Sync	Push/Hold for 2 sec	Initiate Sync/Connection and generate random network name/key on first adapter (PWR LED will start blinking)
		Match network name/key on secondary or additional adapter and connect to first adapter. (PWR LED will start blinking)
		Note: The secondary or additional powerline adapter's Sync button must also be pushed within 2 minutes (120 sec) of pushing the Sync button of the first adapter in order to establish connectivity.
	Push/Hold for 10 sec	Erases the network name/key (All LEDs will turn off and turn back on)
Reset	Push/Hold for 1 sec	Reset device to factory defaults (All LEDs will turn off and turn back on) Note: Will reset to the factory default private network name "HomePlugAV"

Chapter 2: Product Installation

At factory default settings, a pair of TPL-402E 500Mbps Powerline AV adapters with Bonus Outlet (or TPL-402E2K) can be installed into any room in your home or small office with a wall power outlet, without the need for additional software or configuration. To create a simple powerline network using a pair TPL-402E powerline adapters, simply plug one of your TPL-402E adapters into a wall power outlet in one room and plug the other TPL-402E adapter into an available wall power outlet in another room to establish connectivity between the two rooms.

In order to share Internet connectivity through your powerline adapters, it is ideal to install at least one powerline adapter in the room where your modem and router are located and connect the powerline adapter to one of your router's LAN ports via Ethernet. Any additional powerline adapters that are installed and connected in other rooms will then share Internet connectivity through your router. Once the powerline adapters are connected to each other through the electrical system, any additional devices such as computers or network appliances (e.g. Game Console, Blu-ray player, IP Set Top Box, network enabled TV, etc.) connected to any of your powerline adapters via Ethernet can then communicate to each other as well as share Internet connectivity through your router.

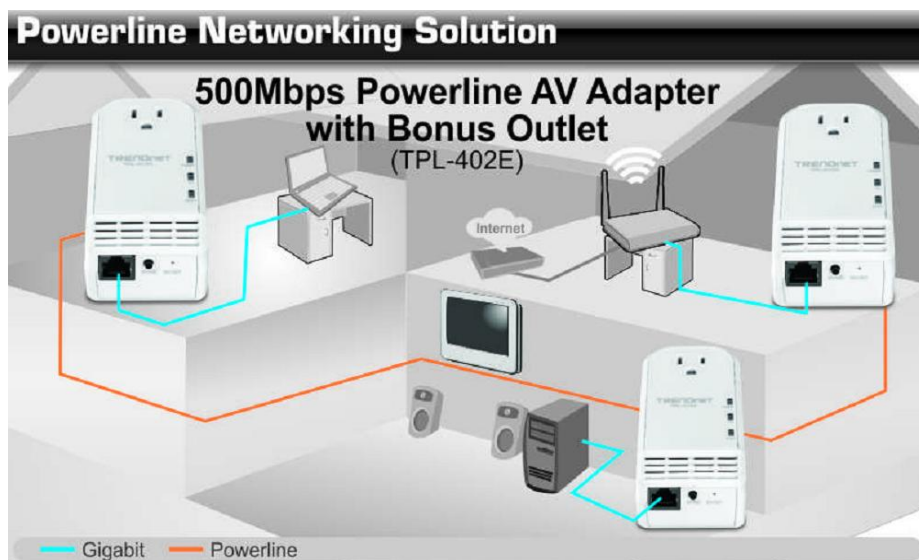

The example diagram shows a typical powerline network configuration in a home environment with 3 powerline adapters installed in different rooms. The orange line represents the powerline connectivity established through your home's electrical system and the blue lines represent Cat. 5, 5e, 6 Ethernet connectivity to your network enabled appliances such as a computer, router, or IP set top box connected to your television.

2.1 Initial Installation

The procedure describes how to create a basic powerline network between a pair of TPL-402E powerline adapters and share Internet connection through a router to a computer or network appliance in another room.

Assuming your router is already installed and configured for Internet connectivity and the TPL-402E powerline adapters are at factory default settings.

1. Plug one of the TPL-402E powerline adapters into an available wall power outlet in the room where your router is located.

Warning: Do not plug the powerline adapter into a power strip that has surge protection. Doing so will degrade power line performance. For best performance, plug all powerline adapters directly into a wall power outlet.

2. Connect one end of the Ethernet Cable into the Ethernet port located at the bottom of the TPL-402E and connect the other end of the Ethernet cable into one of the router's LAN ports.
3. Plug the second TPL-402E powerline adapter into an available wall power outlet in another room where your computer or network appliance (e.g. Game Console, Blu-ray player, IP Set Top Box, network enabled TV, etc.) is located.
4. Connect one end of the Ethernet Cable into the Ethernet port located at the bottom of the second TPL-402E and the other end of the Ethernet cable into the Ethernet port on your computer or network appliance (e.g. Game Console, Blu-ray player, IP Set Top Box, network enabled TV, etc.).
5. To verify connectivity between the TPL-402E powerline adapters, make sure that the PL LED on each TPL-402E is on solid (Green, Amber, Red). Please refer to the LED section 1.5 for details on the LED indicator.
6. You have successfully created a basic powerline network between a pair of TPL-402E powerline adapters. The computer or network appliance connected to the second powerline adapter via Ethernet can now access the Internet.

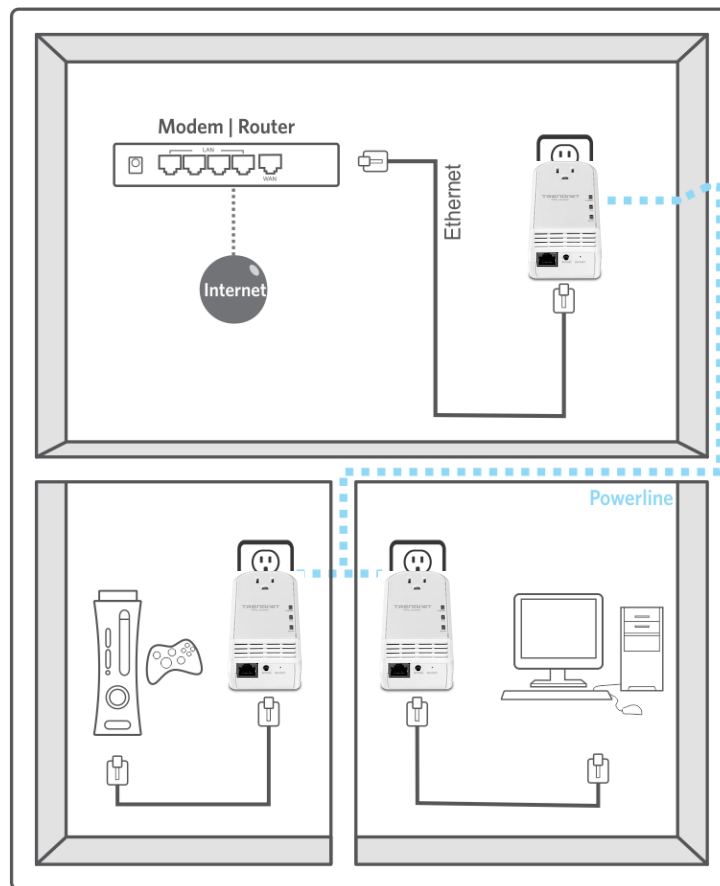

2.2 Securing your Powerline Network

The TPL-402E 500Mbps Powerline AV Adapter with Bonus Outlet has a default network name/security key assignment of “HomePlugAV”. When connecting a pair of TPL-402E powerline adapters, both powerline adapters will be assigned the default network/security key which allows the TPL-402E powerline adapters to establish connectivity through your home or small office’s electrical system without the need for additional software or configuration. For added security, the default network name/security key can be modified using the TPL-402E Sync button covered in the following section or through the use of the Powerline Configuration Utility in Chapter 4.

Note: The default network name/security key assigned to the TPL-402E is “HomePlugAV”. All powerline adapters in the same powerline network must have the same network name/security key in order to establish connectivity. . If the network name/security keys are not the same for all powerline adapters on the same powerline network, the adapter will NOT establish connectivity. TRENDnet Powerline AV models TPL-303E, TPL-304E, TPL-305E, TPL-310AP, TPL-401E, and TPL-402E all have the same default network name/security key assignment of “HomePlugAV”.

2.3 Changing the Network Name/Security Key using the Sync Button

The procedure describes how to create a change the network name/security key between a pair of TPL-402E powerline adapters. This procedure can also be used to establish connectivity between two powerline adapters that are currently disconnected and change the default network name/security key simultaneously.

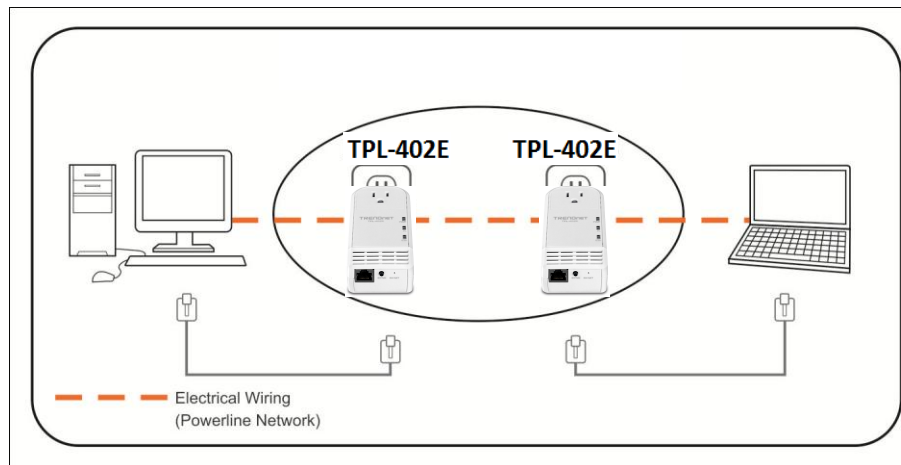

Assuming your TPL-402E powerline adapters are already plugged into wall power outlets and either currently connected or disconnected to each other.

1. Push and hold the Sync button on one of the TPL-402E powerline adapters for 10 seconds and release it. All LEDs will turn off and turn back on. This will erase the current network name/security key assigned to the first powerline adapter.
2. Push and hold the Sync button on the other TPL-402E powerline adapter for 10 seconds and release it. All LEDs will turn off and turn back on. This will erase the current network name/security key assigned to the second powerline adapter.
3. Push and hold the Sync button on the first TPL-402E powerline adapter for 2 seconds and release it. The PWR LED will start blinking. This will initiate sync/connection and generate a random network name/security key assignment to the first adapter.
4. Within 2 minutes (120 sec), push and hold the Sync button on the second TPL-402E powerline adapter for 2 seconds and release it. The PWR LED will start blinking. This will establish connectivity between the two powerline adapters by assigning the second powerline adapter's network name/security key to match the network name/security key of the first powerline adapter.
5. To verify connectivity between the two powerline adapters, make sure that the PL LED on each powerline adapter is on solid (Green, Amber, Red). Please refer to the LED section 1.5 for details on the LED indicator.

2.4 Adding the Powerline Adapter to an Existing Powerline Network

The procedure describes how to add the TPL-402E 500Mbps Powerline AV Adapter with Bonus Outlet to an existing powerline network.

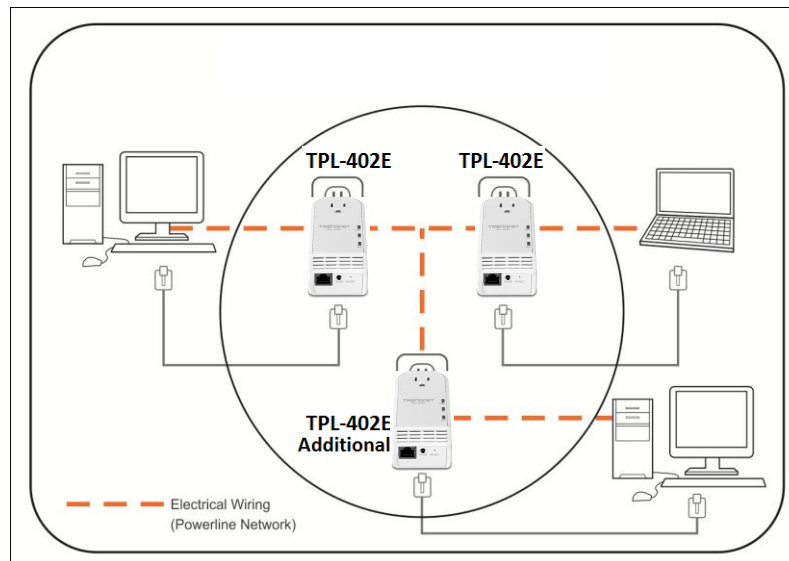

Assuming the two TPL-402E powerline adapters are currently connected to each other and the third TPL-402E (Additional) powerline adapter is currently disconnected.

1. Push and hold the Sync button on the additional TPL-402E powerline adapter for 10 seconds and release it. All LEDs will turn off and turn back on. This will erase the current network name/security key assigned to the additional TPL-402E powerline adapter.
2. Push and hold the Sync button on one of the two TPL-402E powerline adapters that are currently connected to each other for 2 seconds and release it. The PWR LED will start blinking.
3. Within 2 minutes (120 sec), push and hold the Sync button on the additional TPL-402E for 2 seconds and release it. The PWR LED will start blinking. This will establish connectivity between the three powerline adapters by assigning the additional TPL-402E powerline adapter's network name/security key to match the network name/security key of the TPL-402E powerline adapters that are currently connected.
4. To verify connectivity between the three powerline adapters, make sure that the PL LED on each powerline adapter is on solid (Green, Amber, Red). Please refer to the LED section 1.5 for details on the LED indicator.

Chapter 3: Overlapping Powerline Networks

It is possible to create multiple powerline networks on the same electrical system separated and grouped by different network names/security keys. The powerline networks will work and communicate independently of each other which can provide security between different groups of powerline adapters. For example, if you have five powerline adapters (Adapter A, Adapter B, Adapter C, Adapter D, Adapter E), you can group Adapters A,B, and C together on one powerline network and group Adapters D and E on a different powerline network. Each group will use a different network name/security key.

Note: It is recommended that only a maximum of up to 4 powerline networks can be created per electrical system. Any additional powerline networks above the recommended result in significant degradation in powerline performance.

3.1 Move Powerline Adapters between different Powerline Networks

Use the procedures in Chapter 2: Product Installation, to connect one group of adapters, then you can carry out the procedures on another group of adapters to create multiple overlapping powerline networks. This procedure describes how to disconnect a powerline adapter from one powerline network and connect the adapter to a different powerline network.

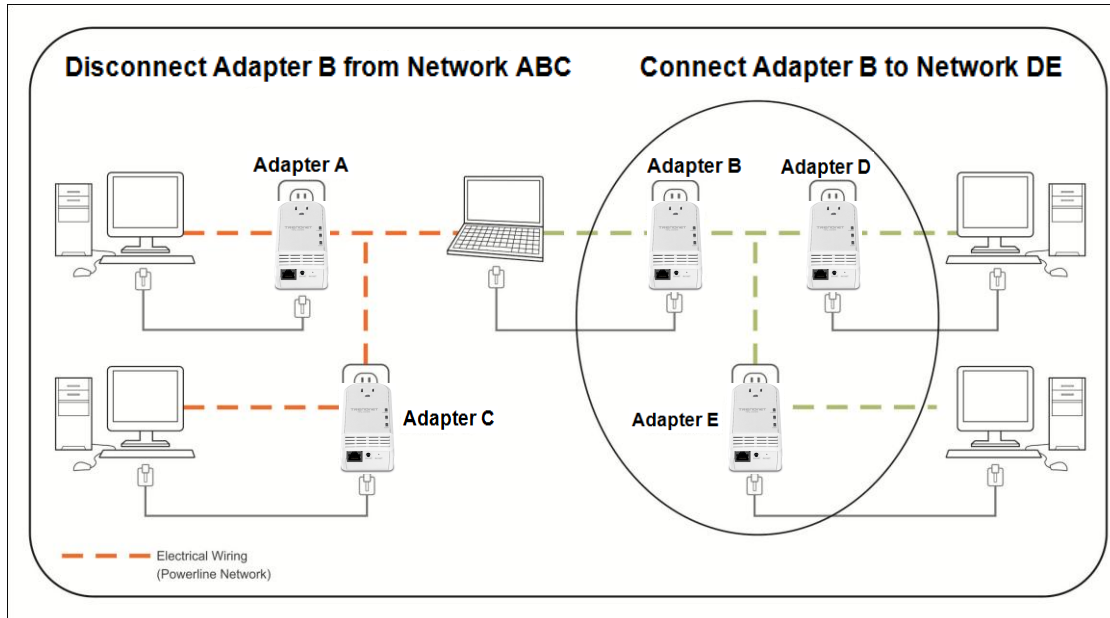

Assuming all powerline adapters are TPL-402E adapters and for reference in the diagram and this procedure, the adapters will be labeled *Adapter A*, *B*, *C*, *D*, and *E*. *Adapters A*, *B*, and *C* are currently connect together to form one powerline network and *Adapters D* and *E* form another powerline network. *Adapter B* will be disconnected from *Adapters A* and *C* and connected to *Adapters D* and *E*.

1. Push and hold the Sync button on *Adapter B* for 10 seconds and release it. All LEDs will turn off and turn back on. This will erase the current network name/security key assigned to *Adapter B* and disconnect from *Adapters A* and *C*.
2. Push and hold the Sync button on *Adapter D* for 2 seconds and release it. The PWR LED will start blinking.
3. Within 2 minutes (120 sec), push and hold the Sync button on *Adapter B* for 2 seconds and release it. The PWR LED will start blinking. This will establish connectivity between *Adapters B*, *D*, and *E* by assigning *Adapter B*'s network name/security key to match the network name/security key of *Adapters D* and *E*.
4. To verify connectivity between the powerline adapters, make sure that the PL LED on each powerline adapter is on solid (Green, Amber, Red). Please refer to the LED section 1.5 for details on the LED indicator.

Chapter 4: Powerline Configuration Utility

The Powerline Configuration Utility is an additional tool that allows you to centrally manage the powerline adapters that are connected to your network. Instead of using a randomly generated key with the Sync button, the utility allows you to manually configure the network name/security key for a single powerline adapter or multiple adapters simultaneously. This tool allows for easy management for multiple powerline adapters in your network.

Note:

1. Before installing and using the utility, write down the 16-digit Device Password (DPW) and MAC Address of each TPL-402E powerline adapter as this will be required to apply changes to remote devices discovered in the utility. This is located on the Device Label, please refer to Section 1.4.
2. Before installing and using the utility, make sure your computer in which you are installing the utility is connected to your network and your TPL-402E adapters are also connected to your network.
3. Make sure all of the TPL-402E powerline adapters are already connected to each other using the procedures in Chapter 2: Product Installation.
4. The utility is only compatible with Windows operating systems. For details, please refer to Section 1.3.

4.1 Software Installation

1. Insert the included CD-ROM into your computer's CD-ROM drive.
2. At the CD Autorun Prompt window, click *Run Autorun.exe*
3. At the CD-ROM menu window, click *Install Utility*.

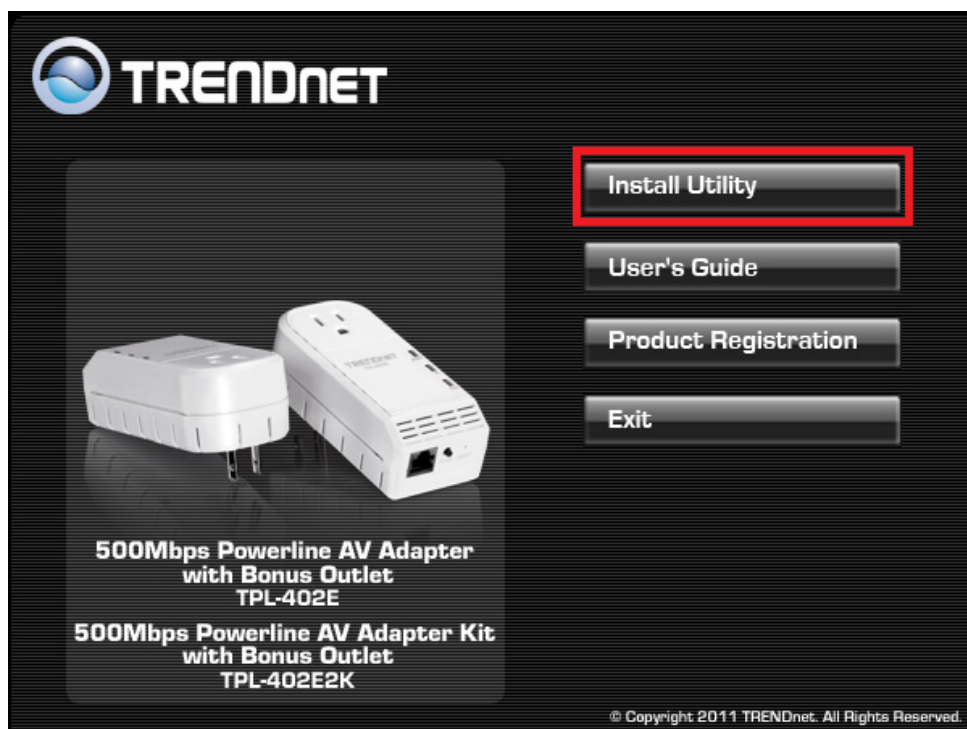

4. At the WinPcap installer window, click *Next*.

Note: The Powerline Configuration Utility requires the use of the WinPcap application. If this prompt does not appear, you may already have the WinPcap application installed. If so, please skip over to Step 9.

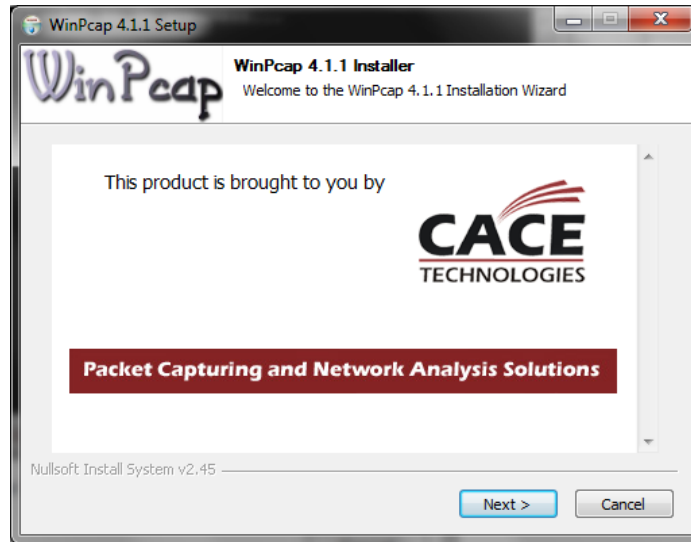

5. In the Setup Wizard window, click *Next*.

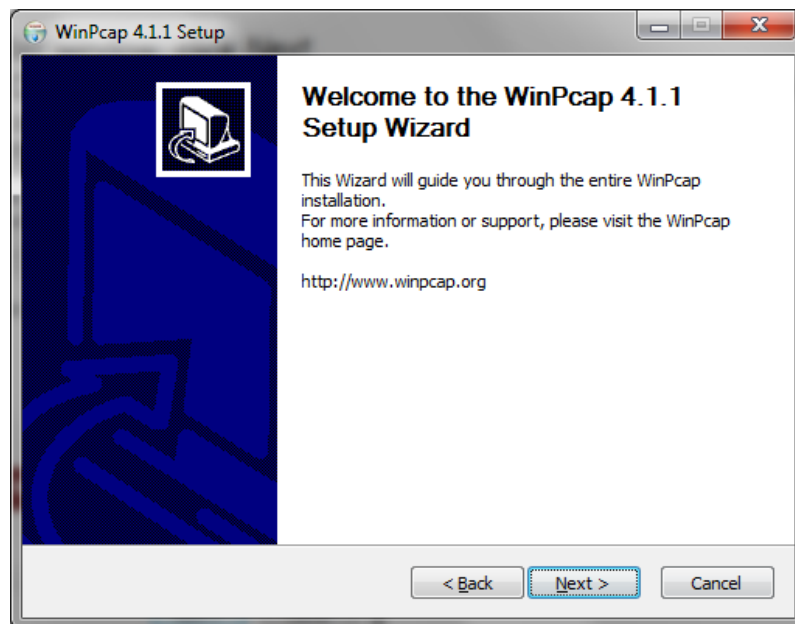

6. In the License Agreement window, click *I Agree*.

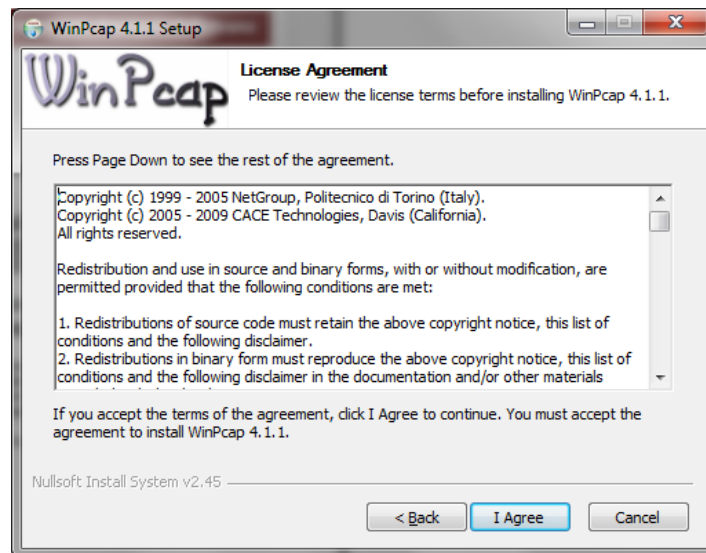

7. In the Install Options window, click *Install*.

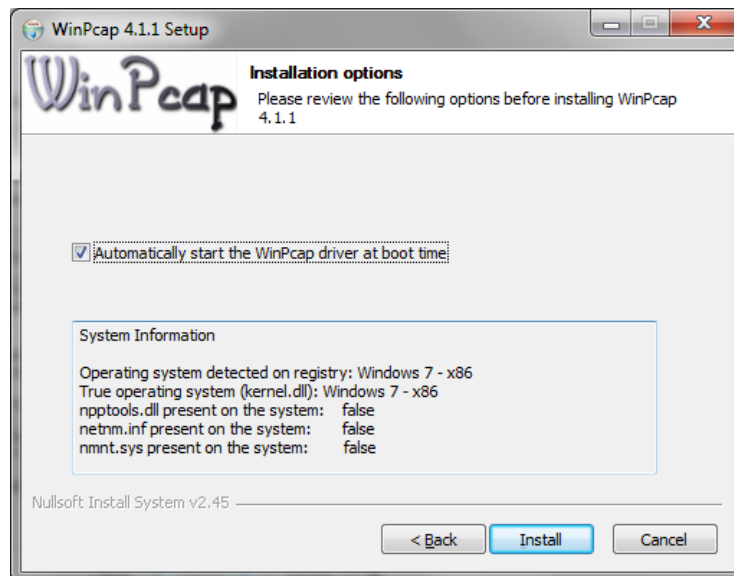

8. At the Setup Wizard Completion window, click *Finish*.

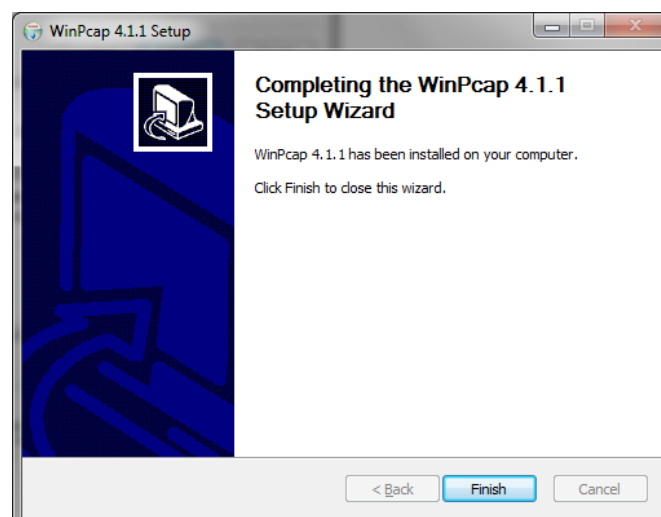

9. The TRENDnet Powerline Configuration Utility installation window will appear automatically. At the Setup Wizard window, click *Next*.

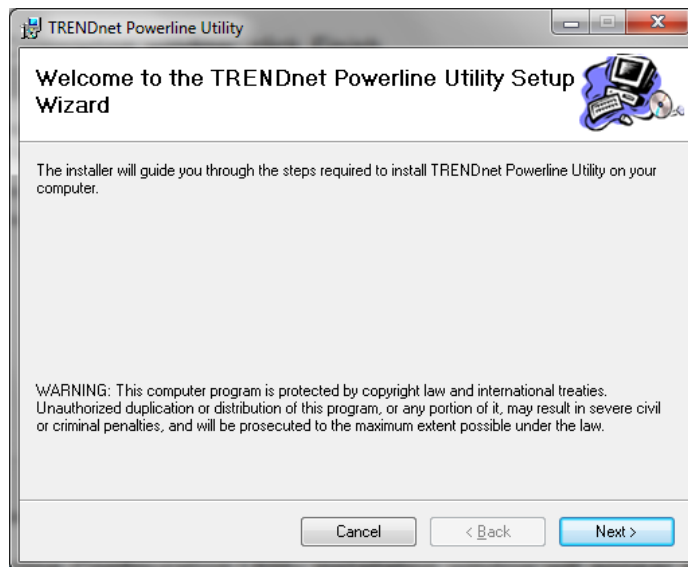

10. In the License Agreement window, check the radio button *I Agree*, and then click *Next*.



11. In the Select Installation Folder window, click *Next*.

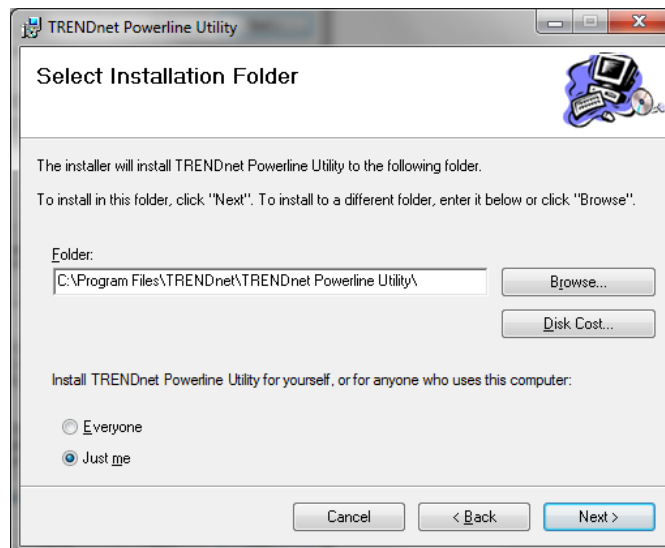

12. In the *Confirm Installation* window, click *Next*.

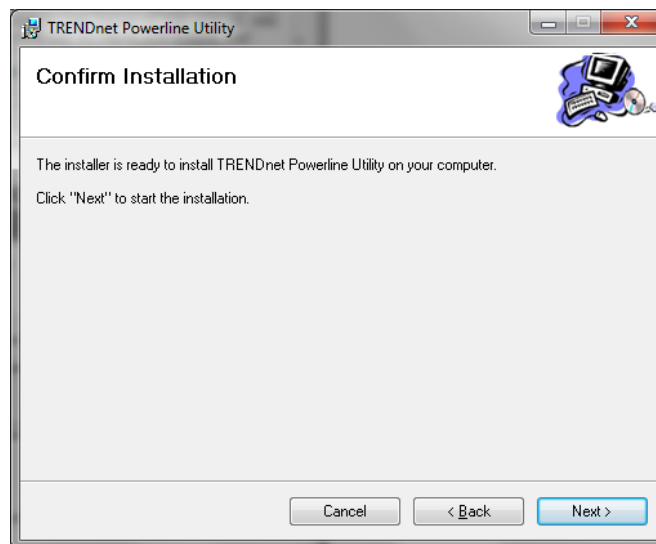

13. At the Installation Complete window, click *Close*.

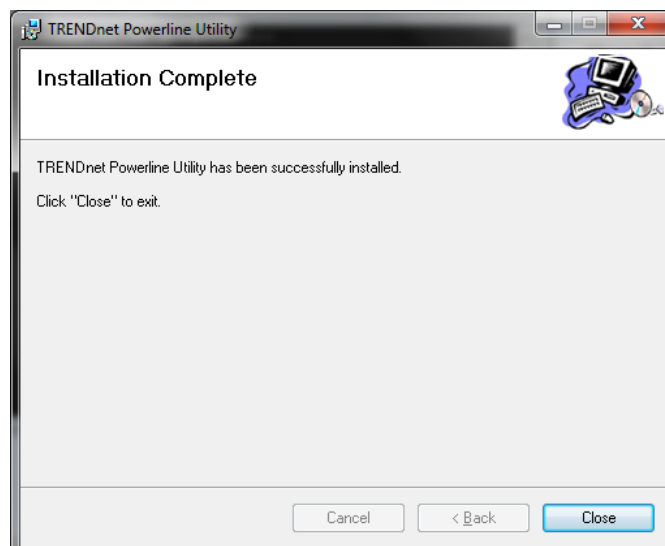

4.2 Using the Utility

Double-click the desktop icon to open the Powerline Configuration Utility application.



The screenshot shows the TRENDnet Powerline Utility application window. The window has a menu bar with 'Main', 'Privacy', 'Diagnostics', and 'About'. The 'Privacy' tab is selected. The main area displays 'Local Device(s) on your computer:' with a table containing one device: 'HomePlug AV 6x00 D...' with MAC address '00:90:47:15:83:02'. Below this, it says '2 Powerline Devices detected: Network Type: Private Autoscan On'. A table lists two devices: 'Device 6' and 'Device 5'. 'Device 5' has a password 'LCHN-ZHDE-VGT...' and a rate of '184.00'. At the bottom, there are buttons for 'Rename', 'Enter Password', 'Add', 'Scan', and 'Close'. Annotations with arrows point to various parts of the window: 'Local Device' points to the local device table; 'Remote Devices' points to the detected devices table; 'Privacy Tab' points to the 'Privacy' menu item; 'Change the Network Name/Security Key' points to the 'Enter Password' button; 'Closes the utility application.' points to the 'Close' button; and four labels at the bottom describe the 'Rename', 'Enter Password', 'Add', and 'Scan' buttons.

Local Device
The closest powerline adapter(s) that connects your computer to the electrical system.

Remote Devices
Powerline adapters that are connected to the selected Local Device across the electrical system.

Privacy Tab
Change the Network Name/Security Key

Rename
Rename the selected Remote Device

Enter Password
Enter the Device Password (DPW) for the selected Remote Device

Add
Add a Remote Device that was not detected

Scan
Scans for Remote Devices that were not detected

Close
Closes the utility application.

- To apply changes to Remote Devices through the Powerline Configuration Utility, you must enter the Device Password (DPW) for each Remote Device located on the Device Label.
- If you have not already done so, please write down the 16-digit Device Password (DPW) and corresponding MAC Address of each TPL-402E powerline adapter as this will be used to input into the utility. This is located on the Device Label, please refer to Section 1.4.

Enter the 16-digit Device Password (DPW) for each Remote Device in the utility

1. Click one of the Remote Devices in the list.
2. Click *Enter Password*.

3. Type in the Device Password according to the corresponding MAC address. Then click *OK*.



4. If successful, the Remote Device will have the Device Password listed next to the device under Password.
Note: If the incorrect Device Password is entered, you will receive an error message. Click *Enter Password* and try entering the password again.

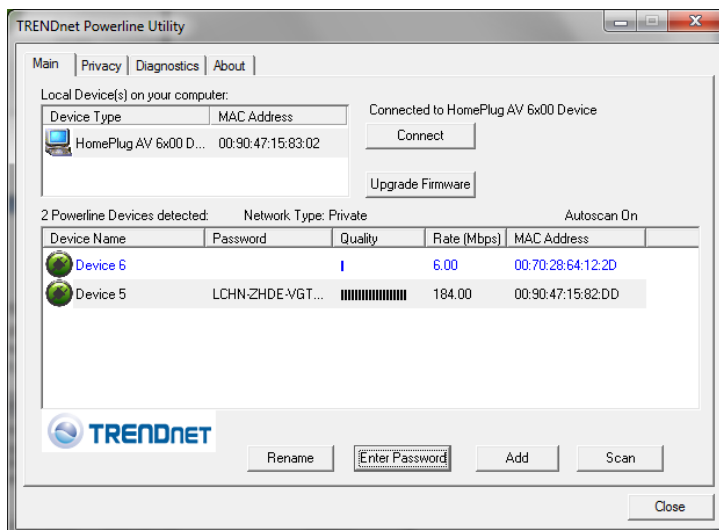

5. Repeat steps 1-4 for any remaining Remote Devices.
6. Once all of the Device Passwords (DPW) are entered into the utility, changes can be applied to the Remote Devices using the utility.

Change the Network Name/Security Key for multiple adapters using the utility

1. Click the *Privacy* tab.
2. Under *Private Network Name*, enter the desired network name/security key and click *Set All Devices*.
3. At the Network Name Setting prompt window, click *OK*.

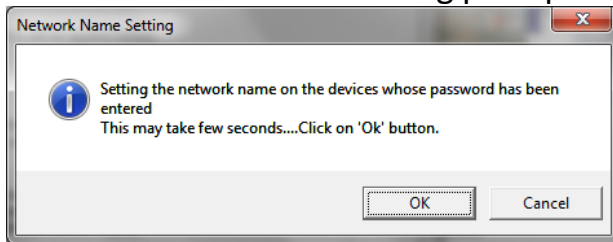

The current network name/security key assignment of the powerline adapter(s).
Note: If you had previously used the Sync button procedure in generating a random network name/security key. This will display "Unknown Networkname"

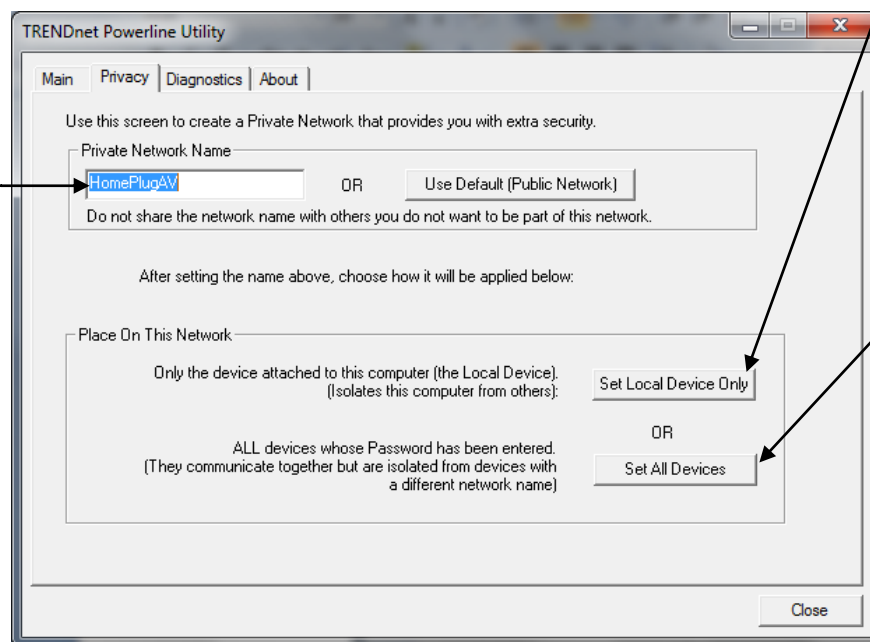

Applies changes to Local Device only.
Note: If you choose this option, you will disconnect the Local Device from the Remote Devices.

Applies changes to Local Device and Remote devices.
Note: If you have not entered the DPW for all remote devices, you will receive an error and the changes will not be applied to remote devices without a DPW.

Chapter 5: Troubleshooting

Please reference the items below if you continue to experience difficulty with installing and using your TPL-402E 500Mbps Powerline AV Adapter with Bonus Outlet.

- Try power cycling the unit by unplugging it from the wall power outlet for 15 seconds and plugging it back in.
- If the PL LED is red indicating good quality only, try plugging the TPL-402E into another available wall power outlet to check if you can obtain better connection quality.
- Use a pin or paperclip and push and hold the Reset button for 1 second on each TPL-402E powerline adapter. All LEDs will turn off and turn back on. This will reset the TPL-402E powerline adapters to the default settings, network name/security key assignment “HomePlugAV”.
- The TPL-402E can provide better connectivity and performance when plugged directly into the wall power outlet instead of a power strip or surge protector.
- Connecting the TPL-402E to a power strip or surge protector may degrade network performance or completely stop network signals.
- The TPL-402E should not be used on GFI protected outlets and electrical systems with AFCI circuit breakers as these items will filter out powerline signals.
- The TPL-402E should not be used in areas with excessive heat.
- Certain florescent or incandescent lights are noise sources on the electrical and can degrade powerline performance.
- If your building has more than one circuit breaker box, the TPL-402E may not be able to establish connectivity between different circuit breaker boxes. In this case, connect a TPL-402E powerline adapter to a power outlet located on each of the circuit breaker boxes, and then connect an Ethernet cable between the TPL-402E powerline adapters to bridge the two circuits together. This will allow the TPL-402E powerline adapters from different circuit breaker boxes connect to each other.

Power Saving: The device will automatically reduce power usage when the connected devices via Ethernet are powered off, unplugged or inactive for more than 3 minutes.

Erp (EuP) Operation: Standby Mode

- Disconnect the Ethernet cables from the device Ethernet ports, and after 3 minutes, the device will enter standby mode. The Power (PWR) LED will flash every 15 seconds to indicate that the device is currently in standby mode.
- To return to active mode, reconnect the Ethernet cables to the device Ethernet ports, and the device will re-enter active mode.

Chapter 6: Specifications

Hardware	
Standards	IEEE 1901, HomePlug® AV, IEEE 802.3, IEEE 802.3x, IEEE 802.3u, IEEE 802.3ab
Interface	<ul style="list-style-type: none"> • 1 x 10/100/1000Mbps Auto-MDIX RJ-45 Port • 1 x electrical power socket with noise filtering (12A max. load) • Power prong <ul style="list-style-type: none"> ○ A: Type B plug ○ EU: Type C – Europlug ○ FR: Type E – French plug
Frequency Band	2 ~ 50 MHz
Modulation	OFDM Symbol modulation on link synchronization, 1024/256/64/8 - QAM, QPSK, BPSK, ROBO carrier
Protocols	TDMA and CSMA/CA
Speed	Powerline: up to 500Mbps** Ethernet: up to 2 Gbps with Full Duplex mode
Utility OS Compatibility	Windows 7 (32/64-bit), Vista (32/64-bit), XP(32/64-bit)
Nodes	Up to 64 (max.) Recommended: Up to 16* per powerline network
Overlapping Powerline Networks Supported	Up to 4 (per electrical system)
Coverage	Up to 300m (984ft.)
Security	128-Bit AES (Advanced Encryption Standard)
LED	Power (PWR) Powerline (PL) with Connection Quality Indication <ul style="list-style-type: none"> • Best (Green) • Better (Amber) • Good (Red) • No connection (Off) Gigabit Ethernet Connection <ul style="list-style-type: none"> • Solid • Blinking • Off
Buttons	Sync, Reset
Dimension (L x W X H)	A: 122 x 55 x 60 mm (4.8 x 2.2 x 2.4 in.) per unit EU/FR: 122 x 55 x 78 mm (4.8 x 2.2 x 3.1 in.) per unit
Weight	A: Total Weight: 318 g (11.2 oz) / Per Unit Weight: 159 g (5.6 oz) EU: Total Weight: 368 g (13 oz) / Per Unit Weight: 184 g (6.5 oz) FR: Total Weight: 374 g (13.2 oz) / Per Unit Weight: 187 g (6.6 oz)
Power Source	A: 100~230V AC, 50~60Hz EU: 220~240V AC, 50Hz
Consumption	Active mode: 5 Watts (max.) Standby mode: 0.72 Watts (max.)

Temperature	Operating: 0° ~ 40°C (32° ~ 104°F) Storage: -20° ~ 70°C (-4° ~ 158°F)
Humidity	Max. 90% (non-condensing)
Certifications	CE, FCC

* Maximum of 16 adapters (nodes) recommended for streaming video across your network. Additional adapters may decrease performance.

** 500Mbps is the maximum theoretical Powerline data rate. Actual throughput will vary depending on environment.

*** Networked Powerline devices need to be plugged into power outlets that are on the same electrical system.

****It is not recommended to use this product on electrical systems that use AFCI circuit breakers or plugged into GFI protected outlets as this may cause performance degradation or loss of connectivity.

Limited Warranty

TRENDnet warrants its products against defects in material and workmanship, under normal use and service, for the following lengths of time from the date of purchase.

TPL-402E / TPL-402E2K – 3 Years Warranty

AC/DC Power Adapter, Cooling Fan, and Power Supply carry 1 year warranty.

If a product does not operate as warranted during the applicable warranty period, TRENDnet shall reserve the right, at its expense, to repair or replace the defective product or part and deliver an equivalent product or part to the customer. The repair/replacement unit's warranty continues from the original date of purchase. All products that are replaced become the property of TRENDnet. Replacement products may be new or reconditioned. TRENDnet does not issue refunds or credit. Please contact the point-of-purchase for their return policies.

TRENDnet shall not be responsible for any software, firmware, information, or memory data of customer contained in, stored on, or integrated with any products returned to TRENDnet pursuant to any warranty.

There are no user serviceable parts inside the product. Do not remove or attempt to service the product by any unauthorized service center. This warranty is voided if (i) the product has been modified or repaired by any unauthorized service center, (ii) the product was subject to accident, abuse, or improper use (iii) the product was subject to conditions more severe than those specified in the manual.

Warranty service may be obtained by contacting TRENDnet within the applicable warranty period and providing a copy of the dated proof of the purchase. Upon proper submission of required documentation a Return Material Authorization (RMA) number will be issued. An RMA number is required in order to initiate warranty service support for all TRENDnet products. Products that are sent to TRENDnet for RMA service must have the RMA number marked on the outside of return packages and sent to TRENDnet prepaid, insured and packaged appropriately for safe shipment. Customers shipping from outside of the USA and Canada are responsible for return shipping fees. Customers shipping from outside of the USA are responsible for custom charges, including but not limited to, duty, tax, and other fees.

WARRANTIES EXCLUSIVE: IF THE TRENDNET PRODUCT DOES NOT OPERATE AS WARRANTED ABOVE, THE CUSTOMER'S SOLE REMEDY SHALL BE, AT TRENDNET'S OPTION, REPAIR OR REPLACE. THE FOREGOING WARRANTIES AND REMEDIES ARE EXCLUSIVE AND ARE IN LIEU OF ALL OTHER WARRANTIES, EXPRESSED OR IMPLIED, EITHER IN FACT OR BY OPERATION OF LAW, STATUTORY OR OTHERWISE, INCLUDING WARRANTIES OF MERCHANTABILITY AND FITNESS FOR A PARTICULAR PURPOSE. TRENDNET NEITHER ASSUMES NOR AUTHORIZES ANY OTHER PERSON TO ASSUME FOR IT ANY OTHER LIABILITY IN CONNECTION WITH THE SALE, INSTALLATION MAINTENANCE OR USE OF TRENDNET'S PRODUCTS.

TRENDNET SHALL NOT BE LIABLE UNDER THIS WARRANTY IF ITS TESTING AND EXAMINATION DISCLOSE THAT THE ALLEGED DEFECT IN THE PRODUCT DOES NOT EXIST OR WAS CAUSED BY CUSTOMER'S OR ANY THIRD PERSON'S MISUSE, NEGLIGENCE, IMPROPER INSTALLATION OR TESTING, UNAUTHORIZED ATTEMPTS TO REPAIR OR MODIFY, OR ANY OTHER CAUSE BEYOND THE RANGE OF THE INTENDED USE, OR BY ACCIDENT, FIRE, LIGHTNING, OR OTHER HAZARD.

LIMITATION OF LIABILITY: TO THE FULL EXTENT ALLOWED BY LAW TRENDNET ALSO EXCLUDES FOR ITSELF AND ITS SUPPLIERS ANY LIABILITY, WHETHER BASED IN CONTRACT OR TORT (INCLUDING NEGLIGENCE), FOR INCIDENTAL, CONSEQUENTIAL, INDIRECT, SPECIAL, OR PUNITIVE DAMAGES OF ANY KIND, OR FOR LOSS OF REVENUE OR PROFITS, LOSS OF BUSINESS, LOSS OF INFORMATION OR DATA, OR OTHER FINANCIAL LOSS ARISING OUT OF OR IN CONNECTION WITH THE SALE, INSTALLATION, MAINTENANCE, USE, PERFORMANCE, FAILURE, OR INTERRUPTION OF THE POSSIBILITY OF SUCH DAMAGES, AND LIMITS ITS LIABILITY TO REPAIR, REPLACEMENT, OR REFUND OF THE

PURCHASE PRICE PAID, AT TRENDNET'S OPTION. THIS DISCLAIMER OF LIABILITY FOR DAMAGES WILL NOT BE AFFECTED IF ANY REMEDY PROVIDED HEREIN SHALL FAIL OF ITS ESSENTIAL PURPOSE.

Governing Law: This Limited Warranty shall be governed by the laws of the state of California.

Some TRENDnet products include software code written by third party developers. These codes are subject to the GNU General Public License ("GPL") or GNU Lesser General Public License ("LGPL").

Go to <http://www.trendnet.com/gpl> or <http://www.trendnet.com> Download section and look for the desired TRENDnet product to access to the GPL Code or LGPL Code. These codes are distributed WITHOUT WARRANTY and are subject to the copyrights of the developers. TRENDnet does not provide technical support for these codes. Please go to <http://www.gnu.org/licenses/gpl.txt> or <http://www.gnu.org/licenses/lgpl.txt> for specific terms of each license.

PWP05202009v2



TRENDnet[®]

Product Warranty Registration

Please take a moment to register your product online.
Go to TRENDnet's website at <http://www.trendnet.com/register>