

TRENDNET®

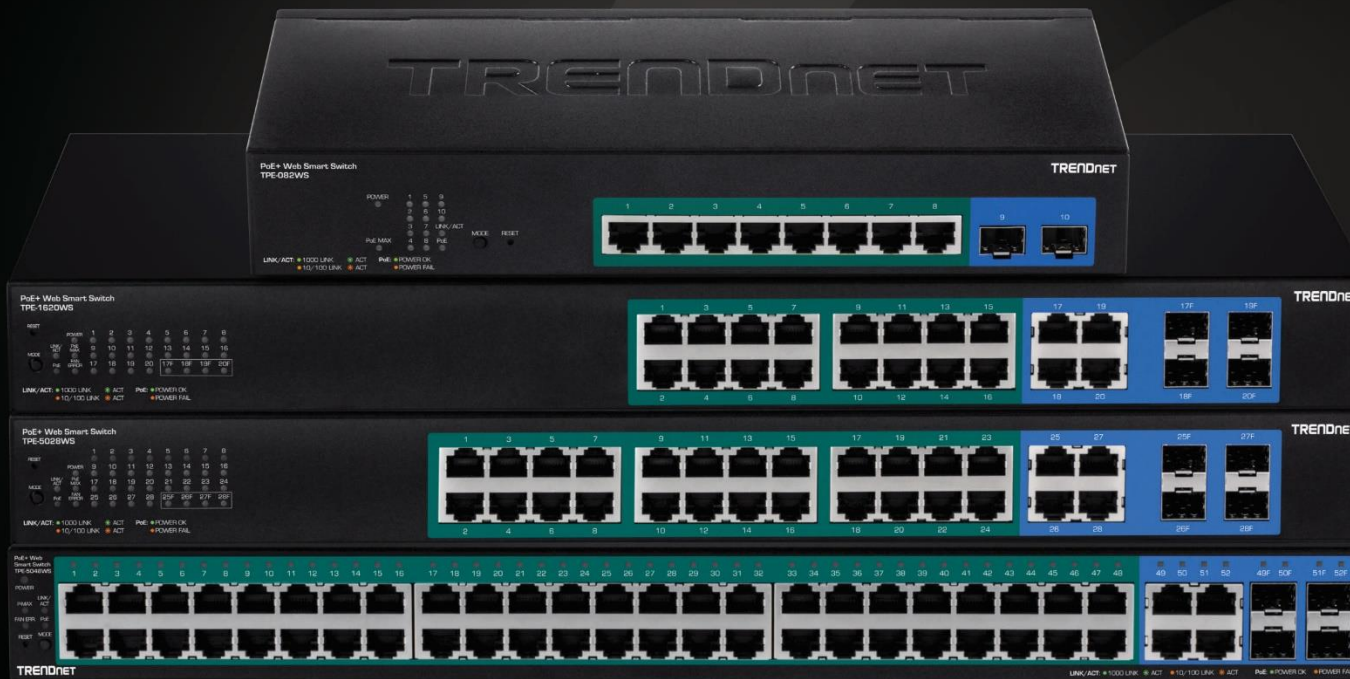

PoE Web Smart Switch Series User's Guide

Thank you for purchasing your new TRENDnet PoE Web Smart Switch!

Please note: The scope of this user's guide encompasses multiple products with varying features. Images, artwork, and other specificities including port count, interfaces etc. may not be identical to the model you purchased. Please consult the specific model specifications for your unit for a full list of supported features.

*Please ensure your switch's firmware version is **V2.10.010 or newer** for **Layer 2+ management features**. See the *Firmware Upgrade* section in this document for additional information regarding the firmware upgrade procedure.*

Contents

PoE Web Smart Switch Series Product Overview	i
TPE-082WS Overview	i
Package Contents	i
TPE-082WS Hardware Features.....	i
TPE-1620WS v2 & TPE-1620WSF Overview.....	iii
Package Contents	iii
TPE-1620WS/TPE-1620WSF Hardware Features.....	iii
TPE-2840WS v2 Overview	v
Package Contents	v
TPE-2840WS Hardware Features.....	v
TPE-5028WS Overview	vii
Package Contents	vii
TPE-5028WS Hardware Features.....	vii
TPE-5240WS Overview	ix
Package Contents	ix
TPE-5240WS Hardware Features.....	ix
TPE-5048WS Overview	xi
Package Contents	xi
TPE-5048WS Hardware Features.....	xi
Switch Installation	1
Desktop Hardware Installation.....	1
Rack Mount Hardware Installation.....	1
Basic IP Configuration.....	2
Connect additional devices to your switch.....	4
Accessing switch management interfaces.....	5
Access your switch management page.....	5
System Info	5
View your switch status information.....	5

System.....	7	System Log.....	23
System Management.....	7	View and setup your switch logging.....	23
Set your system information	7	SNMP.....	24
L3 Feature.....	8	Settings.....	24
IPv4 Interface.....	8	View.....	25
IPv4 ARP Aging Time.....	9	Group.....	26
IPv4 Static ARP.....	9	User.....	27
IPv4 Static/Default Route.....	10	Community.....	28
Set your IPv6 settings.....	11	Trap.....	29
Add IPv6 neighbors.....	12	RMON.....	30
Configure IPv6 Routing Table.....	13	Settings.....	30
DNS.....	14	Statistics.....	31
Set your DNS server settings.....	14	History.....	32
IP Access List.....	15	Alarms.....	33
Restrict access to switch management page.....	15	Events.....	34
Administration.....	16	Statistics.....	36
Change administrator password and add accounts.....	16	Traffic.....	36
Timeout.....	17	Error.....	37
Change web idle login timeout settings.....	17	IEEE 802.3az EEE.....	38
System Time.....	17	Enable IEEE 802.3az Power Saving Mode.....	38
Set the switch date and time.....	17	Network.....	39
SSL.....	19	Physical Interface.....	39
Enable HTTPS/SSL (Secure Socket Layer) management access.....	19	Configure Physical Interfaces.....	39
SSH.....	20	Spanning Tree.....	41
Enable SSH (Secure Shell) management access.....	20	Protocol.....	41
Telnet.....	21	Port.....	42
Enable Telnet management access.....	21	MST.....	43
DHCP Auto Configuration.....	22	Instance.....	44
Enable DHCP Auto Configuration.....	22	MST Port.....	45
		Trunk.....	46
		Settings.....	46
		Status.....	47

Port Priority	47	Dynamic.....	62
Mirroring.....	48	Private.....	63
Configure port mirror settings.....	48	Current.....	64
Loopback Detection	49	GVRP.....	64
Enable loopback detection	49	GVRP Global Settings.....	64
Static Unicast	50	Port Settings	65
Add static unicast entries to the switch.....	50	Time Settings	66
Static Multicast	51	Voice VLAN	67
Add static multicast entries to the switch	51	Settings	68
IGMP Snooping	52	OUI.....	69
Settings	52	LLDP	70
Router Ports.....	53	Enable and configure LLDP	70
MLD Snooping.....	54	Settings	70
Settings	54	Basic TLVs Settings.....	72
Router Port	55	Dot1 TLVs Settings	72
Multicast VLAN	56	Dot3 TLVs Settings	72
Multicast VLAN Settings.....	56	MED Port Settings.....	73
Multicast VLAN Table.....	56	LLDP Statistics Information	73
Multicast VLAN Group Settings	56	LLDP Local Port Information	73
Multicast VLAN Access Settings.....	57	Neighbor	73
Multicast Filtering.....	58	MAC VLAN	74
Multicast Filtering.....	58	MAC VLAN	74
Bandwidth Control.....	58	Protocol VLAN.....	74
Storm Control	58	Protocol VLAN Profile	74
Ingress Rate Limiting.....	59	Protocol VLAN Profile Interface.....	75
Egress Rate Limiting.....	59	QoS (Quality of Service)	76
VLAN	60	CoS.....	76
Tagged	60	Set CoS priority settings.....	76
Port	61	Port Priority	77
Forwarding.....	62	Set Port Priority	77
		DSCP	77

Set DSCP (Differentiated Services Code Point) Class Mapping settings	77	Dynamic ARP Inspection	93
Scheduling Algorithm.....	78	Settings	93
Set the Scheduling Algorithm	78	ARP Inspection Validation	93
IPv6 Traffic Class	79	ARP Inspection Port Settings	94
Configure the IPv6 Traffic Class Settings	79	ARP Inspection VLAN	94
PoE (Power over Ethernet)	80	ARP Inspection Statistics.....	95
Power over Ethernet.....	80	ARP Inspection VLAN	95
Configure PoE settings	81	ACL.....	96
Time Range	82	ACL Configuration Wizard.....	96
Configure PoE Time Range.....	82	Access Profile List	97
Security.....	83	ACL Finder	98
Port Access Control.....	83	Tools.....	99
Configure Port Access Control	83	Firmware Upgrade.....	99
Dial-in User	84	Upgrade your switch's firmware	99
Create Dial-In Users (Local Authentication Method).....	84	Firmware Upgrade via HTTP Settings	99
RADIUS.....	85	Firmware Upgrade via TFTP Settings	100
Add RADIUS Servers (RADIUS Authentication Method)	85	Config Backup Restore.....	100
TACACS+	86	Config Backup/Restore	100
Add TACACS+ Servers (TACACS+ Authentication Method).....	86	Backup/Restore via HTTP Settings.....	100
Destination MAC Filter	87	Backup/Restore via TFTP Settings	101
Destination MAC Filter.....	87	Diagnostics.....	102
Denial of Service	88	Cable Diagnostics Test	102
Denial of Service (DoS).....	88	Reboot	103
DHCP Snooping	89	Reboot/Reset to factory defaults	103
Settings	89	Ping.....	104
VLAN	90	Network Connectivity Test (Ping Tool)	104
Interfaces	91	Using the Web Smart Switch Management Utility	105
Binding	92	System Requirements.....	105
		Installation	105
		Using the Utility	106

Launching the Utility..... 106
Discovery List 107
Monitor List 107
Device Setting 108
Main Menu Options..... 109

Hardware Features and Specifications 110

Web Smart Switch Series Software Specifications 112

Quick Installation Guide/Troubleshooting 114

Appendix 115

PoE Web Smart Switch Series Product Overview

TPE-082WS Overview



TPE-082WS

Package Contents

In addition to your switch, the package includes:

- Quick Installation Guide
- CD-ROM (Utility & User's Guide)
- Power adapter (54V DC, 1.67A)
- Rack mount kit

If any package contents are missing or damaged, please contact the retail store, online retailer, or reseller/distributor from which the product was purchased.

TPE-082WS Hardware Features

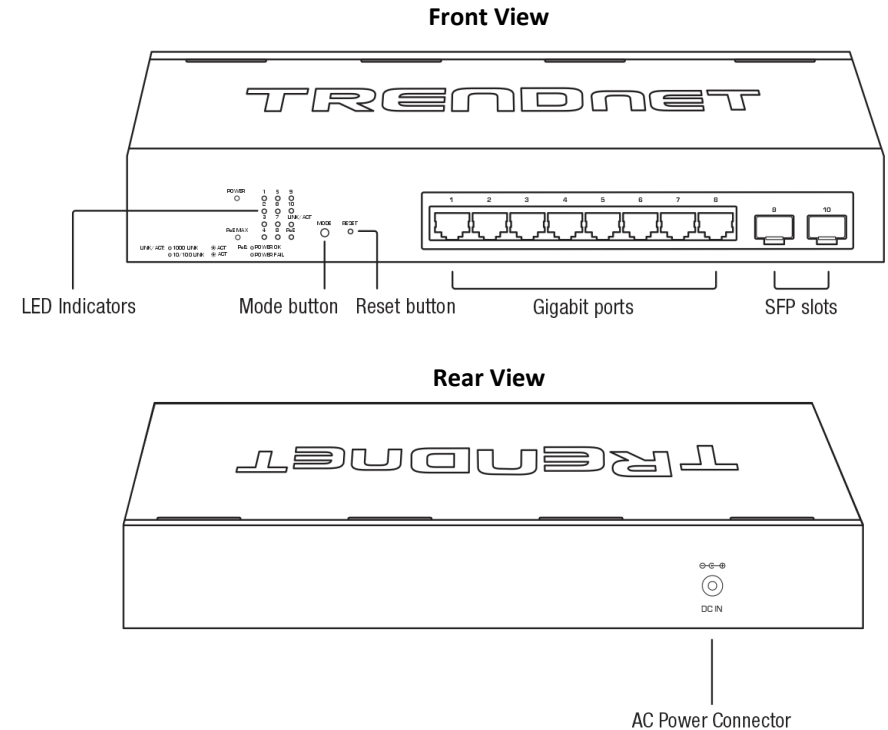

- **Reset Button** – Press and hold the button 1~5 seconds and release to reboot the device. Pressing the button more than 6 seconds will reset the switch to factory defaults. The ports LEDs will turn off to indicate that the reset was initiated.
- **Mode Button** – Press the mode button to change LED indicators to display Link/Activity Mode, or PoE Mode.
- **Gigabit Ethernet PoE+ Ports (1-8)** – Connect either network PoE+ or non-PoE devices.
- **SFP Slots (9-10)** – Supports optional 100BASE-SX/LX mini-GBIC modules for uplink or downlink connections.

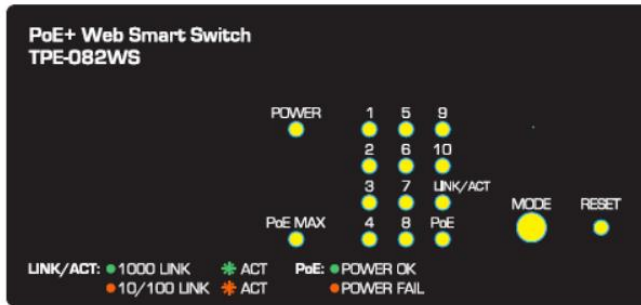

Diagnostic LEDs

- Power LED**

On	: When the Power LED is on, the device is receiving power.
Off	: When the Power LED is off, the power adapter is not connected or the device is not receiving power.

- PoE MAX (Power over Ethernet Max.)**

On	: When reaching near the max PoE power budget provided 75W or above, the LED will turn on and the system will not provide power additional PD (PoE client devices) after max PoE budget is reached.
Off	: When the PoE power provided is below the 75W PoE power budget.

- Gigabit Ethernet PoE+ Port LEDs (1-8)**

- Link/Activity button Mode**

Green on	: When the Green LED is on, the respective port is connected to a 1Gbps Ethernet network.
Amber on	: When the Green LED lights on, the respective port is connected to a 10/100Mbps Ethernet network.
Green Blinking	: When the LED is blinking green, the port is transmitting or receiving data on the network at 1Gbps speed.
Amber Blinking	: When the LED is blinking amber, the port is transmitting or receiving data on the network at 10/100Mbps speed.
Off	: When the LED is off, the respective port is disconnected.

- Gigabit Ethernet Port PoE+ LEDs (1-8)**

- PoE LED button Mode**

Green on	: When the Green LED is on, the connected device is receiving power.
Amber on	: When the Amber LED lights on, the connected PoE device is not receiving power. The cause is either insufficient power budget, or due to Class/PowerLimit restrictions in the PoE configurations.
Off	: When the LED is off, the respective port is either not connected to a PoE device or is disconnected.

- SFP Slots (9-10)**

- Link/Activity**

Green on	: When the SFP LED is on, the link established using the SFP module is operating at 1Gbps speed.
Green blinking	: When the SFP LED is blinking, the port is transmitting or receiving data on through the 1Gbps link established.
Amber on	: When the SFP LED is on, the link established using the SFP module is operating at 100Mbps speed.
Amber blinking	: When the SFP LED is blinking, the port is transmitting or receiving data on through the 100Mbps link established.
Off	: No link established.



TPE-1620WS v2 & TPE-1620WSF Overview**Package Contents**

In addition to your switch, the package includes:

- Quick Installation Guide
- CD-ROM (Utility & User's Guide)
- Power cord (1.8 m / 6 ft.)
- Rack mount kit

If any package contents are missing or damaged, please contact the retail store, online retailer, or reseller/distributor from which the product was purchased.

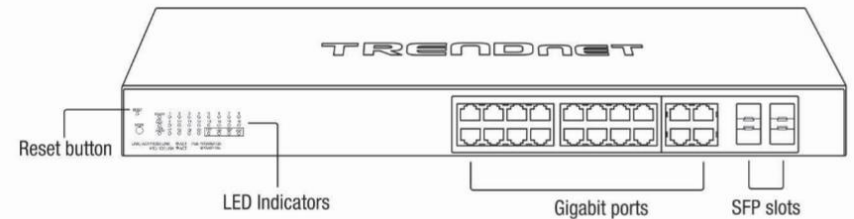
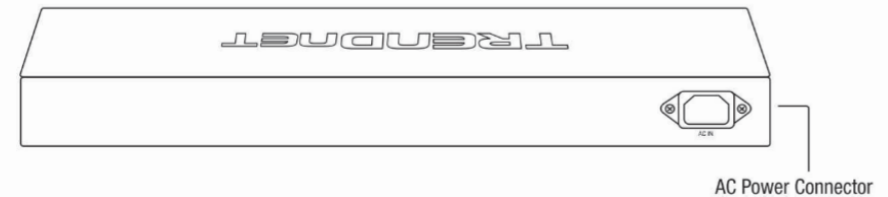
TPE-1620WS/TPE-1620WSF Hardware Features**Front View****Rear View**

- **Reset Button** – Press and hold the button 1~5 seconds and release to reboot the device. Pressing the button more than 6 seconds will reset the switch to factory defaults. The ports LEDs will turn off to indicate that the reset was initiated.
- **Mode Button** – Press the mode button to change LED indicators to display Link/Activity Mode, or PoE Mode.
- **PoE+ Gigabit Ports (1-16)** – Connect network PoE+ or non-PoE devices.
- **Gigabit Ethernet Ports (17-20)** – Connect network devices. Ports 17-20 are shared with SFP slots 17F-20F and are disabled when SFP slots (17F-20F) are in use.
- **SFP Slots (17F-20F)** – Supports optional 1000BASE-SX/LX mini-GBIC modules for uplink or downlink connections.

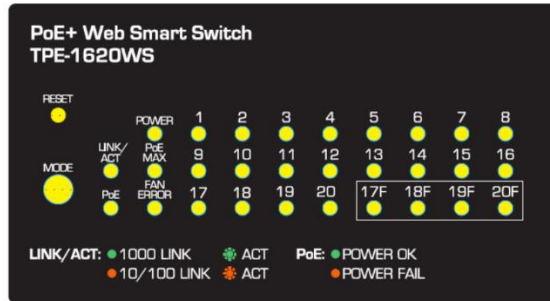

Diagnostic LEDs

- **Power LED**

On	: When the Power LED is on, the device is receiving power.
Off	: When the Power LED is off, the power adapter is not connected or the device is not receiving power.

- **PoE MAX (Power over Ethernet Max.)**

On	: When reaching near the max PoE power budget provided 185W or above, the LED will turn on and the system will not provide power additional PD (PoE client devices) after max PoE budget is reached.
Off	: When the PoE power provided is below the PoE power budget.

- **Fan Error**

On	: When the internal fan is not operating normally, the Fan Error LED will turn on.
Off	: When the internal fan is operating normally, the Fan Error LED will remain off.

- **Gigabit Ethernet Port LEDs (1-20)**

- **Link/Activity button Mode**

Green on	: When the Green LED is on, the respective port is connected to a 1Gbps Ethernet network.
Amber on	: When the Green LED lights on, the respective port is connected to a 10/100Mbps Ethernet network.

Green Blinking	: When the LED is blinking green, the port is transmitting or receiving data on the network at 1Gbps speed.
Amber Blinking	: When the LED is blinking amber, the port is transmitting or receiving data on the network at 10/100Mbps speed.
Off	: When the LED is off, the respective port is disconnected.

- **Gigabit Ethernet PoE+ Port LEDs (1-16)**

- **PoE LED button Mode**

Green on	: When the Green LED is on, the connected device is receiving power.
Amber on	: When the Amber LED lights on, the connected PoE device is not receiving power. The cause is either insufficient power budget, or due to Class/PowerLimit restrictions in the PoE configurations.
Off	: When the LED is off, the respective port is either not connected to a PoE device or is disconnected.

- **SFP Slots (17F-20F)**

- **Link/Activity**

Green on	: When the SFP LED is on, the link established using the SFP module is operating at 1Gbps speed.
Green blinking	: When the SFP LED is blinking, the port is transmitting or receiving data on through the 1Gbps link established.
Amber on	: When the SFP LED is on, the link established using the SFP module is operating at 100Mbps speed.
Amber blinking	: When the SFP LED is blinking, the port is transmitting or receiving data on through the 100Mbps link established.
Off	: No link established.

TPE-2840WS v2 Overview**Package Contents**

In addition to your switch, the package includes:

- Quick Installation Guide
- CD-ROM (Utility & User's Guide)
- Power cord (1.8 m / 6 ft.)
- Rack mount kit

If any package contents are missing or damaged, please contact the retail store, online retailer, or reseller/distributor from which the product was purchased.

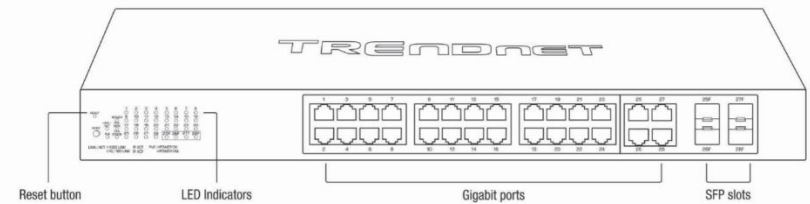
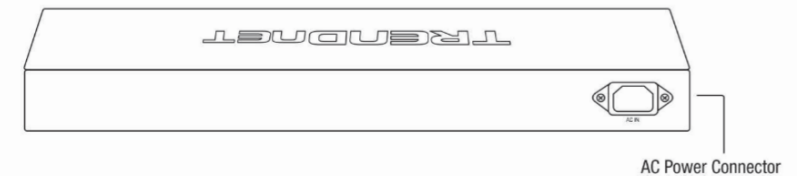
TPE-2840WS Hardware Features**Front View****Rear View**

- **Reset Button** – Press and hold the button 1~5 seconds and release to reboot the device. Pressing the button more than 6 seconds will reset the switch to factory defaults. The ports LEDs will turn off to indicate that the reset was initiated.
- **Mode Button** – Press the mode button to change LED indicators to display Link/Activity Mode, or PoE Mode.
- **PoE+ Gigabit Ports (1-24)** – Connect network PoE+ or non-PoE devices.
- **Gigabit Ethernet Ports (25-28)** – Connect network devices. Ports 25-28 are shared with SFP slots 25F-28F and are disabled when SFP slots (25F-28F) are in use.
- **SFP Slots (25F-28F)** – Supports optional 1000BASE-SX/LX mini-GBIC modules for uplink or downlink connections.

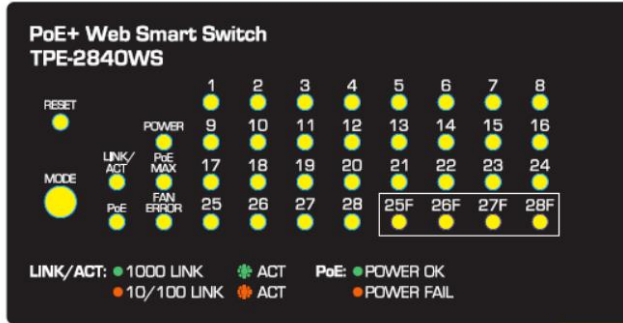

Diagnostic LEDs

- **Power LED**

On	: When the Power LED is on, the device is receiving power.
Off	: When the Power LED is off, the power adapter is not connected or the device is not receiving power.

- **PoE MAX (Power over Ethernet Max.)**

On	: When reaching near the max PoE power budget provided 185W or above, the LED will turn on and the system will not provide power additional PD (PoE client devices) after max PoE budget is reached.
Off	: When the PoE power provided is below the 185W PoE power budget.

- **Fan Error**

On	: When the internal fan is not operating normally, the Fan Error LED will turn on.
Off	: When the internal fan is operating normally, the Fan Error LED will remain off.

- **Gigabit Ethernet Port LEDs (1-28)**

- **Link/Activity button Mode**

Green on	: When the Green LED is on, the respective port is connected to a 1Gbps Ethernet network.
Amber	: When the Green LED lights on, the respective port is

on	connected to a 10/100Mbps Ethernet network.
Green : Blinking	: When the LED is blinking green, the port is transmitting or receiving data on the network at 1Gbps speed.
Amber : Blinking	: When the LED is blinking amber, the port is transmitting or receiving data on the network at 10/100Mbps speed.
Off	: When the LED is off, the respective port is disconnected.

- **Gigabit Ethernet PoE+ Port LEDs (1-24)**

- **PoE LED button Mode**

Green on	: When the Green LED is on, the connected device is receiving power.
Amber on	: When the Amber LED lights on, the connected PoE device is not receiving power. The cause is either insufficient power budget, or due to Class/PowerLimit restrictions in the PoE configurations.
Off	: When the LED is off, the respective port is either not connected to a PoE device or is disconnected.

- **SFP Slots (25F-28F)**

- **Link/Activity**

Green on	: When the SFP LED is on, the link established using the SFP module is operating at 1Gbps speed.
Green blinking	: When the SFP LED is blinking, the port is transmitting or receiving data on through the 1Gbps link established.
Amber on	: When the SFP LED is on, the link established using the SFP module is operating at 100Mbps speed.
Amber blinking	: When the SFP LED is blinking, the port is transmitting or receiving data on through the 100Mbps link established.
Off	: No link established.

TPE-5028WS Overview



Package Contents

In addition to your switch, the package includes:

- Quick Installation Guide
- CD-ROM (Utility & User's Guide)
- Power cord (1.8 m / 6 ft.)
- Rack mount kit

If any package contents are missing or damaged, please contact the retail store, online retailer, or reseller/distributor from which the product was purchased.

TPE-5028WS Hardware Features

Front View

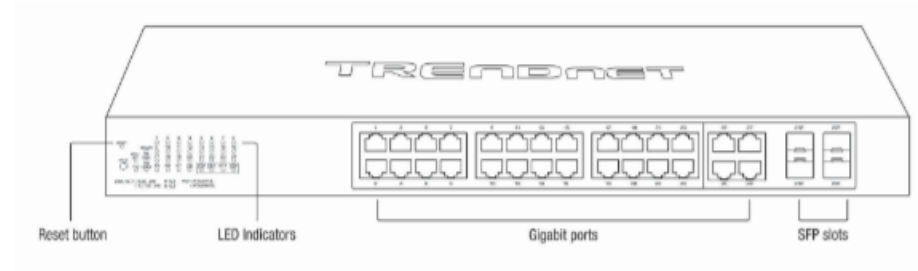

Rear View



- **Reset Button** – Press and hold the button 1~5 seconds and release to reboot the device. Pressing the button more than 6 seconds will reset the switch to factory defaults. The ports LEDs will turn off to indicate that the reset was initiated.
- **Mode Button** – Press the mode button to change LED indicators to display Link/Activity Mode, or PoE Mode.
- **PoE+ Gigabit Ports (1-24)** – Connect network PoE+ or non-PoE devices.
- **Gigabit Ethernet Ports (25-28)** – Connect network devices. Ports 25-28 are shared with SFP slots 25F-28F and are disabled when SFP slots (25F-28F) are in use.
- **SFP Slots (25F-28F)** – Supports optional 1000BASE-SX/LX mini-GBIC modules for uplink or downlink connections.

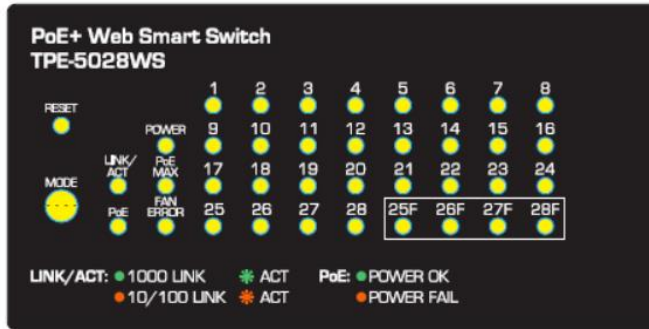

Diagnostic LEDs

- **Power LED**

On	: When the Power LED is on, the device is receiving power.
Off	: When the Power LED is off, the power adapter is not connected or the device is not receiving power.

- **PoE MAX (Power over Ethernet Max.)**

On	: When reaching near the max PoE power budget provided 370W or above, the LED will turn on and the system will not provide power additional PD (PoE client devices) after max PoE budget is reached.
Off	: When the PoE power provided is below the 370W PoE power budget.

- **Fan Error**

On	: When the internal fan is not operating normally, the Fan Error LED will turn on.
Off	: When the internal fan is operating normally, the Fan Error LED will remain off.

- **Gigabit Ethernet Port LEDs (1-28)**

- **Link/Activity button Mode**

Green on	: When the Green LED is on, the respective port is connected to a 1Gbps Ethernet network.
----------	---

Amber on	: When the Green LED lights on, the respective port is connected to a 10/100Mbps Ethernet network.
Green Blinking	: When the LED is blinking green, the port is transmitting or receiving data on the network at 1Gbps speed.
Amber Blinking	: When the LED is blinking amber, the port is transmitting or receiving data on the network at 10/100Mbps speed.
Off	: When the LED is off, the respective port is disconnected.

- **Gigabit Ethernet PoE+ Port LEDs (1-24)**

- **PoE LED button Mode**

Green on	: When the Green LED is on, the connected device is receiving power.
Amber on	: When the Amber LED lights on, the connected PoE device is not receiving power. The cause is either insufficient power budget, or due to Class/PowerLimit restrictions in the PoE configurations.
Off	: When the LED is off, the respective port is either not connected to a PoE device or is disconnected.

- **SFP Slots (25F-28F)**

- **Link/Activity**

Green on	: When the SFP LED is on, the link established using the SFP module is operating at 1Gbps speed.
Green blinking	: When the SFP LED is blinking, the port is transmitting or receiving data on through the 1Gbps link established.
Amber on	: When the SFP LED is on, the link established using the SFP module is operating at 100Mbps speed.
Amber blinking	: When the SFP LED is blinking, the port is transmitting or receiving data on through the 100Mbps link established.
Off	: No link established.

TPE-5240WS Overview

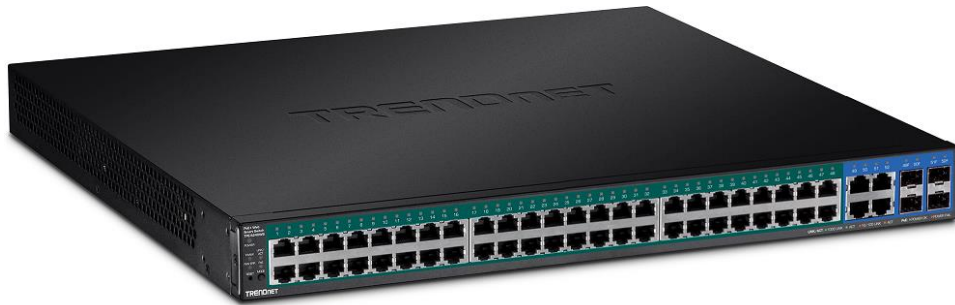

Package Contents

In addition to your switch, the package includes:

- Quick Installation Guide
- CD-ROM (Utility & User's Guide)
- Power cord (1.8 m / 6 ft.)
- Rack mount kit

If any package contents are missing or damaged, please contact the retail store, online retailer, or reseller/distributor from which the product was purchased.

TPE-5240WS Hardware Features

Front View

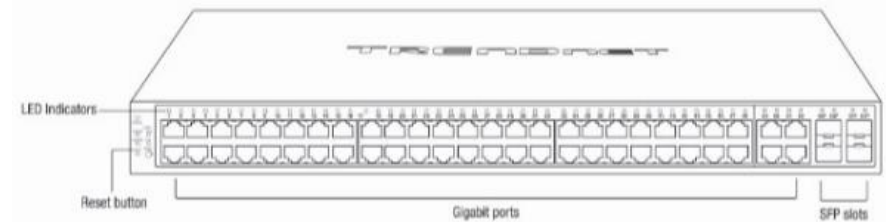

Rear View



- **Reset Button** – Press and hold the button 1~5 seconds and release to reboot the device. Pressing the button more than 6 seconds will reset the switch to factory defaults. The ports LEDs will turn off to indicate that the reset was initiated.
- **Mode Button** – Press the mode button to change LED indicators to display Link/Activity Mode, or PoE Mode.
- **PoE+ Gigabit Ports (1-48)** – Connect network PoE+ or non-PoE devices.
- **Gigabit Ethernet Ports (49-52)** – Connect network devices. Ports 49-52 are shared with SFP slots 49F-52F and are disabled when SFP slots (49F-52F) are in use.
- **SFP Slots (49F-52F)** – Supports optional 1000BASE-SX/LX mini-GBIC modules for uplink or downlink connections.

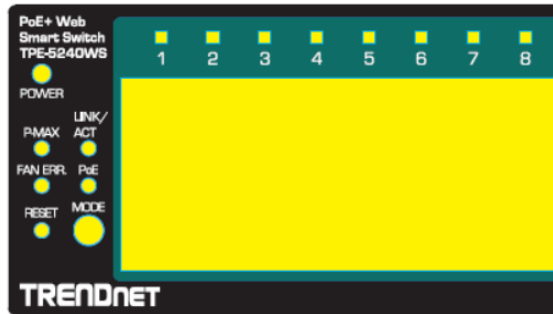

Diagnostic LEDs

- **Power LED**

On	: When the Power LED is on, the device is receiving power.
Off	: When the Power LED is off, the power adapter is not connected or the device is not receiving power.

- **PoE MAX (Power over Ethernet Max.)**

On	: When reaching near the max PoE power budget provided 370W or above, the LED will turn on and the system will not provide power additional PD (PoE client devices) after max PoE budget is reached.
Off	: When the PoE power provided is below the 370W PoE power budget.

- **Fan Error**

On	: When the internal fan is not operating normally, the Fan Error LED will turn on.
Off	: When the internal fan is operating normally, the Fan Error LED will remain off.

- **Gigabit Ethernet Port LEDs (1-52)**

- **Link/Activity button Mode**

Green on	: When the Green LED is on, the respective port is connected to a 1Gbps Ethernet network.
Amber on	: When the Green LED lights on, the respective port is connected to a 10/100Mbps Ethernet network.

Green Blinking	: When the LED is blinking green, the port is transmitting or receiving data on the network at 1Gbps speed.
Amber Blinking	: When the LED is blinking amber, the port is transmitting or receiving data on the network at 10/100Mbps speed.
Off	: When the LED is off, the respective port is disconnected.

- **Gigabit Ethernet PoE+ Port LEDs (1-48)**

- **PoE LED button Mode**

Green on	: When the Green LED is on, the connected device is receiving power.
Amber on	: When the Amber LED lights on, the connected PoE device is not receiving power. The cause is either insufficient power budget, or due to Class/PowerLimit restrictions in the PoE configurations.
Off	: When the LED is off, the respective port is either not connected to a PoE device or is disconnected.

- **SFP Slots (49F-52F)**

- **Link/Activity**

Green on	: When the SFP LED is on, the link established using the SFP module is operating at 1Gbps speed.
Green blinking	: When the SFP LED is blinking, the port is transmitting or receiving data on through the 1Gbps link established.
Amber on	: When the SFP LED is on, the link established using the SFP module is operating at 100Mbps speed.
Amber blinking	: When the SFP LED is blinking, the port is transmitting or receiving data on through the 100Mbps link established.
Off	: No link established.

TPE-5048WS Overview

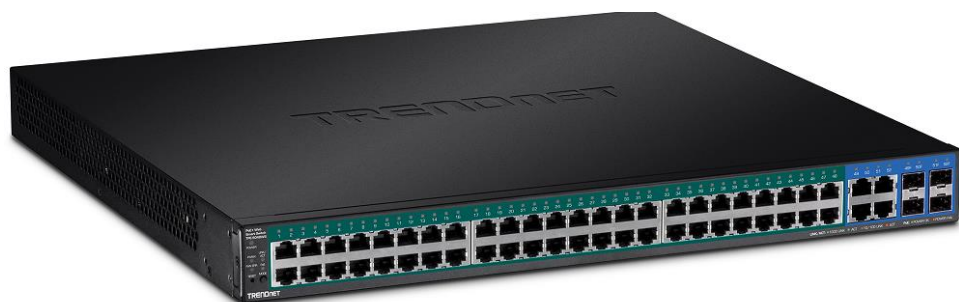

Package Contents

In addition to your switch, the package includes:

- Quick Installation Guide
- CD-ROM (Utility & User's Guide)
- Power cord (1.8 m / 6 ft.)
- Rack mount kit

If any package contents are missing or damaged, please contact the retail store, online retailer, or reseller/distributor from which the product was purchased.

TPE-5048WS Hardware Features

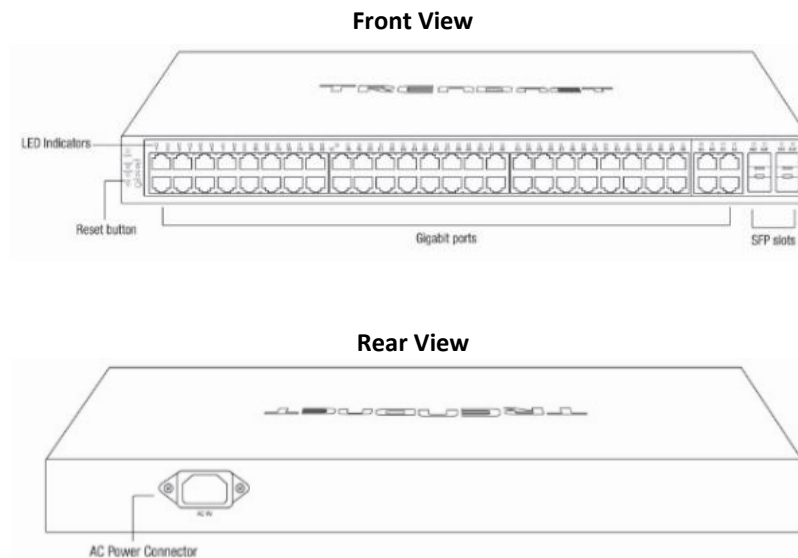

- **Reset Button** – Press and hold the button 1~5 seconds and release to reboot the device. Pressing the button more than 6 seconds will reset the switch to factory defaults. The ports LEDs will turn off to indicate that the reset was initiated.
- **Mode Button** – Press the mode button to change LED indicators to display Link/Activity Mode, or PoE Mode.
- **PoE+ Gigabit Ports (1-48)** – Connect network PoE+ or non-PoE devices.
- **Gigabit Ethernet Ports (49-52)** – Connect network devices. Ports 49-52 are shared with SFP slots 49F-52F and are disabled when SFP slots (49F-52F) are in use.
- **SFP Slots (49F-52F)** – Supports optional 1000BASE-SX/LX mini-GBIC modules for uplink or downlink connections.

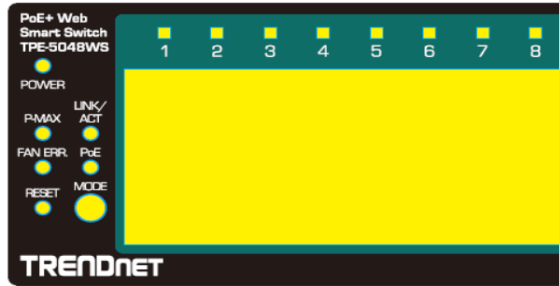

Diagnostic LEDs

- **Power LED**

On	: When the Power LED is on, the device is receiving power.
Off	: When the Power LED is off, the power adapter is not connected or the device is not receiving power.

- **PoE MAX (Power over Ethernet Max.)**

On	: When reaching near the max PoE power budget provided 740W or above, the LED will turn on and the system will not provide power additional PD (PoE client devices) after max PoE budget is reached.
Off	: When the PoE power provided is below the 740W PoE power budget.

- **Fan Error**

On	: When the internal fan is not operating normally, the Fan Error LED will turn on.
Off	: When the internal fan is operating normally, the Fan Error LED will remain off.

- **Gigabit Ethernet Port LEDs (1-52)**

- **Link/Activity button Mode**

Green on	: When the Green LED is on, the respective port is connected to a 1Gbps Ethernet network.
Amber on	: When the Green LED lights on, the respective port is connected to a 10/100Mbps Ethernet network.

Green Blinking	: When the LED is blinking green, the port is transmitting or receiving data on the network at 1Gbps speed.
Amber Blinking	: When the LED is blinking amber, the port is transmitting or receiving data on the network at 10/100Mbps speed.
Off	: When the LED is off, the respective port is disconnected.

- **Gigabit Ethernet PoE+ Port LEDs (1-48)**

- **PoE LED button Mode**

Green on	: When the Green LED is on, the connected device is receiving power.
Amber on	: When the Amber LED lights on, the connected PoE device is not receiving power. The cause is either insufficient power budget, or due to Class/PowerLimit restrictions in the PoE configurations.
Off	: When the LED is off, the respective port is either not connected to a PoE device or is disconnected.

- **SFP Slots (49F-52F)**

- **Link/Activity**

Green on	: When the SFP LED is on, the link established using the SFP module is operating at 1Gbps speed.
Green blinking	: When the SFP LED is blinking, the port is transmitting or receiving data on through the 1Gbps link established.
Amber on	: When the SFP LED is on, the link established using the SFP module is operating at 100Mbps speed.
Amber blinking	: When the SFP LED is blinking, the port is transmitting or receiving data on through the 100Mbps link established.
Off	: No link established.

Switch Installation

Desktop Hardware Installation

The site where you install the hub stack may greatly affect its performance. When installing, consider the following pointers:

Note: Your switch model may be different than the one shown in the example illustrations.

- Install the Switch in a fairly cool and dry place.
- Install the Switch in a site free from strong electromagnetic field generators (such as motors), vibration, dust, and direct exposure to sunlight.
- Leave at least 10cm of space at the front and rear of the hub for ventilation.
- Install the Switch on a sturdy, level surface that can support its weight, or in an EIA standard-size equipment rack. For information on rack installation, see the next section, Rack Mounting.
- When installing the Switch on a level surface, attach the rubber feet to the bottom of each device. The rubber feet cushion the hub and protect the hub case from scratching.

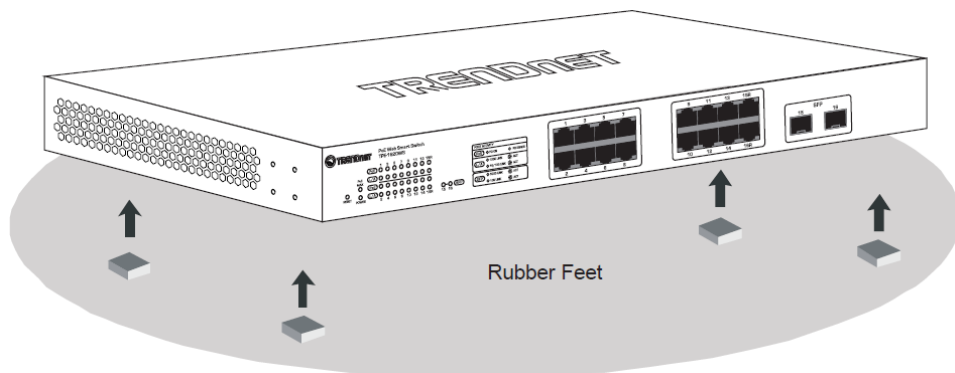

Rack Mount Hardware Installation

The switch can be mounted in an EIA standard-size, 19-inch rack, which can be placed in a wiring closet with other equipment. Attach the mounting brackets at the switch's front panel (one on each side), and secure them with the provided screws.

Note: The switch model may be different than the one shown in the example illustrations.

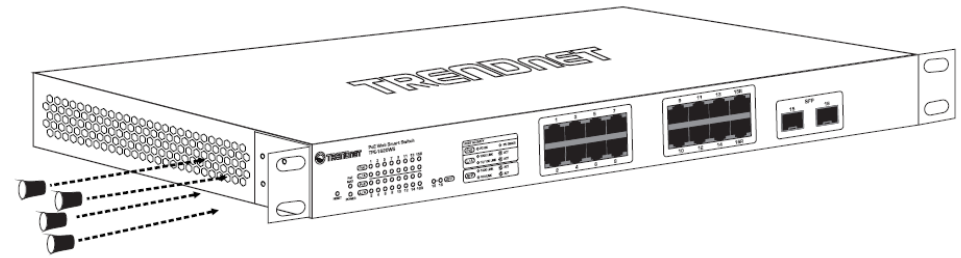

Then, use screws provided with the equipment rack to mount each switch in the rack.

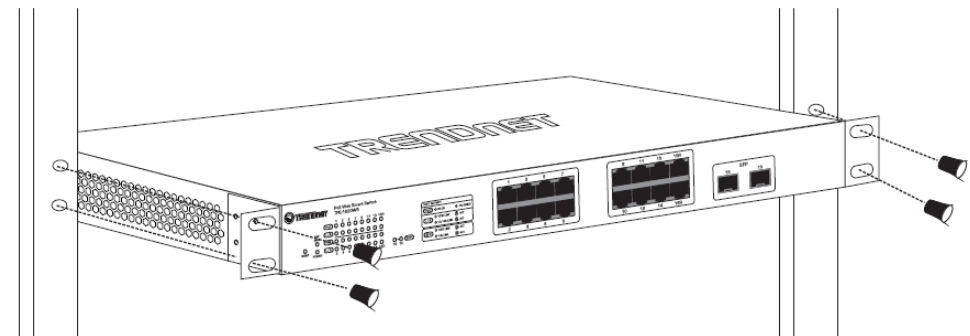

Basic IP Configuration

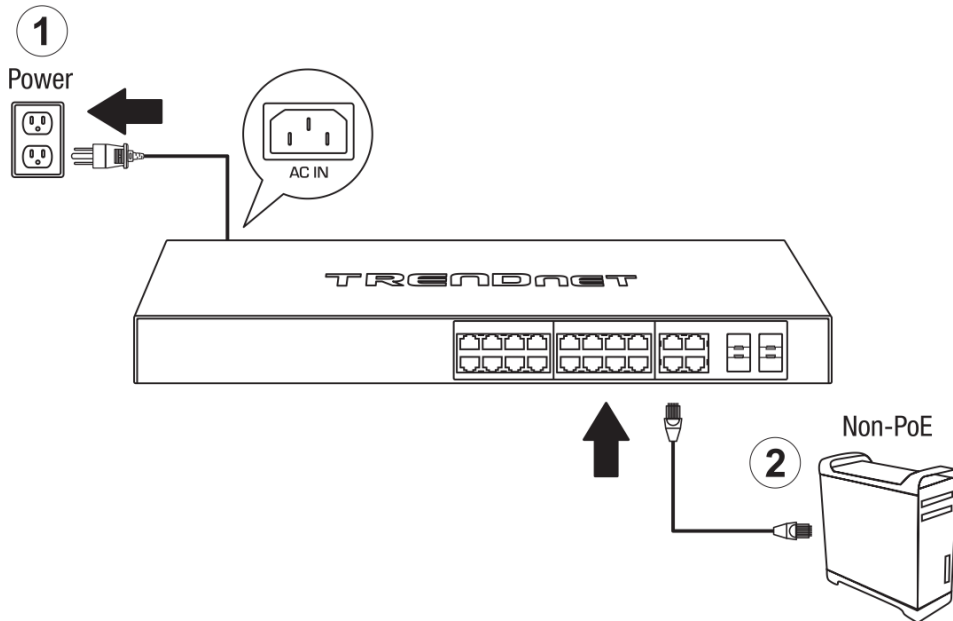

3. Assign a static IP address to your computer's network adapter in the subnet of 192.168.10.x (e.g. 192.168.10.25) and a subnet mask of 255.255.255.0.

4. Open your web browser, and type the IP address of the switch in the address bar, and then press **Enter**. The default IP address is **192.168.10.200**.



5. Enter the User Name and Password, and then click **Login**. By default:

User Name: **admin**

Password: **admin**

Note: User name and password are case sensitive.

The screenshot shows the LOGIN page of the TRENDnet web interface. It features a dark background with a light blue ID card icon and the word "LOGIN" in large white letters. Below the icon are two input fields for "User Name" and "Password", and a blue "LOGIN" button at the bottom right.

6. Click **System**, **L3 Feature**, and then click **IPv4 Interface**.

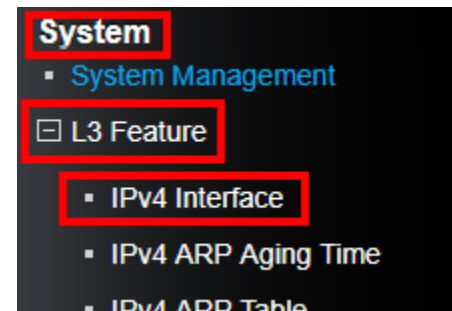

7. Click on **Edit** for interface vlan1.

Note: All other functions of this page will be explained in detail in its respective section.

IPv4 Interface

Interface VLAN (1-4094)

[Add](#) [Find](#)

Interface Table

Total Entries : 1

Interface	State	IP Address	Link Status	Action
vlan1	Enabled	192.168.14.204/255.255.255.0 Manual	Up	Edit

Page 1/1 [First Page](#) [Previous Page](#) [Next Page](#) [Last Page](#) Page [GO](#)

8. Configure the switch IP address settings to be within your network subnet, then click **Apply** under the **IP Settings**.

Status Settings

Interface

State

[Apply](#)

IP Settings

Get IP Form

IP Address . . .

Subnet Mask . . .

[Apply](#)

9. When the confirmation message appears click **OK**.

Be sure to re-log back into the switch using the new IP address and save the configuration to your flash.

WARNING

 The management session will be disconnected. Use new IP address to connect to device.

[OK](#) [Cancel](#)

NOTE: The configured settings are only applied to the switch's **temporary** memory and will be lost upon the next power-cycle. Please follow these next steps to save the configurations to the switch's NV-RAM to ensure the settings will remain throughout power-cycles and reboots:

1. At the bottom of the left hand panel, click **Save**.

Security

Tools

[Save](#)

2. Select the Config you would like to save the settings to, click **Save Settings to Flash**, then click **OK**.

Note: This step saves all configuration changes to the NV-RAM to ensure that if the switch is rebooted or power cycled, the configuration changes will still be applied.

Save Settings to Flash

Config File: startup-config

Note: The switch will stop responding while saving the current configuration to flash.

[Save Settings to Flash](#)

Connect additional devices to your switch

You can connect computers or other network devices to your switch using Ethernet cables to connect them to one of the available Gigabit Ethernet Ports, Gigabit Ethernet PoE Ports, Gigabit Ethernet PoE+ Ports, Gigabit Ethernet UPoE Ports, or SFP Ports. Check the status of the LED indicators on the front panel of your switch to ensure the physical cable connection from your computer or device. You can use either the Gigabit Ethernet ports or SFP connections as network uplinks. (SFP modules sold separately)

Note: If you encounter issues connecting to your network, there may be a problem with your computer or device network settings. Please ensure that your computer or device network settings (also called TCP/IP settings) are configured properly within the network subnet your switch is connected.

Note: Your switch model may be different than the one shown in the example illustrations.

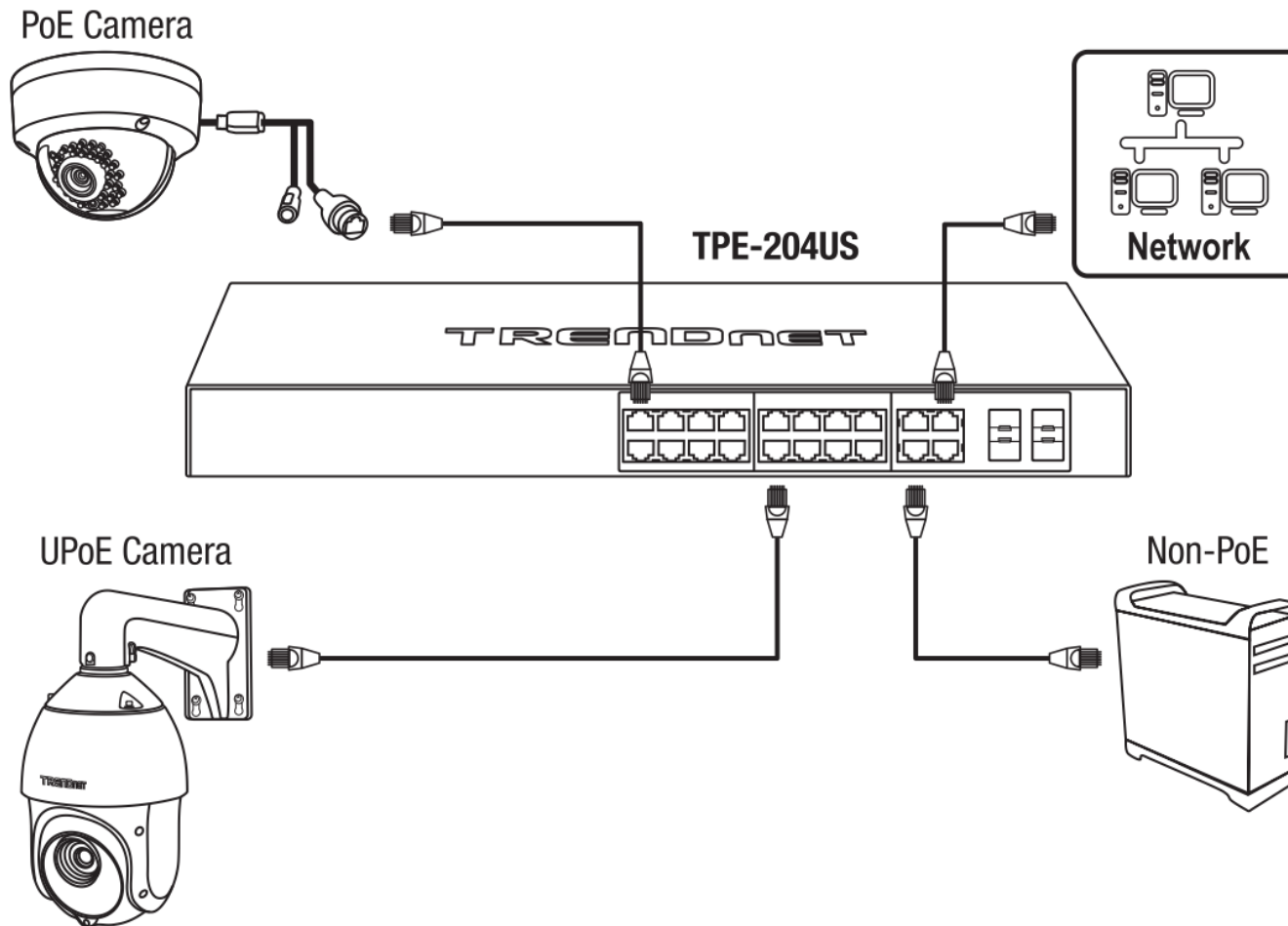

Accessing switch management interfaces

Access your switch management page

Note: Your switch default management IP address <http://192.168.10.200> is accessed through the use of your Internet web browser (e.g. Internet Explorer®, Firefox®, Chrome™, Safari®, Opera™) and will be referenced frequently in this User's Guide. Throughout this user's guide, the term Web Configuration will be used to reference access from web management page.

1. Open your web browser and go to its IP address (default: <http://192.168.10.200>). Your switch will prompt you for a user name and password.



2. Enter the user name and password. By default:

User Name: **admin**

Password: **admin**

Note: User Name and Password are case sensitive.

System Info

View your switch status information

Switch Info

You may want to check the general system information of your switch such as firmware version, boot loader information and system uptime. Other information includes H/W version, RAM/Flash size, administration information, IPv4 and IPv6 information.

1. Log into your switch management page (see "[Access your switch management page](#)" on page 5).
2. Click on **Switch Info**.

Switch Information

- **System Up For** – The duration your switch has been running continuously without a restart/power cycle (hard or soft reboot) or reset.
- **Runtime Image:** The current software or firmware version your switch is running.
- **Boot Loader** – The current boot loader version your switch is running.

Switch Information	
System Up For:	0 day(s),4 hr(s),57 min(s),45 sec(s)
Runtime Image:	2.10.010
Boot Loader:	1.00.011

Hardware Information

- **DRAM Size:** Displays your switch RAM memory size.
- **Flash Size:** Displays your switch Flash memory size.

Hardware Information	
DRAM Size:	MB
Flash Size:	MB

Administration Information

- **System Name** – Displays the identifying system name of your switch. This information can be modified under the **System** section.
- **System Location** - Displays the identifying system location of your switch. This information can be modified under the **System** section.
- **System Contact** – Displays the identifying system contact or system administrator of your switch. This information can be modified under the **System** section.

Administration Information	
System Name:	
System Location:	
System Contact:	

System MAC Address, IPv4 Information

- **MAC Address:** Displays the switch system MAC address.
- **IP Address** – Displays the current IPv4 address assigned to your switch.
- **Subnet Mask** – Displays the current IPv4 subnet mask assigned to your switch.
- **Default Gateway** – Displays the current gateway address assigned to your switch.

System MAC Address, IPv4 Information	
MAC Address:	00:01:02:03:04:05
IP Address:	192.168.10.200
Subnet Mask:	255.255.255.0
Default Gateway:	0.0.0.0

IPv6 Information

- **IPv6 Unicast Address / Prefix Length:** Displays the current IPv6 address and prefix assigned to your switch.
- **IPv6 Default Gateway:** Displays the current IPv6 default gateway address assigned to your switch.
- **Link Local Address / Prefix Length:** Displays the current Link Local address and prefix length assigned to your switch

IPv6 Information	
IPv6 Unicast Address / Prefix Length:	
IPv6 Default Gateway:	
Link Local Address / Prefix length:	

Automatic Network Features

- **IPv4 DHCP Client Mode:** Displays if your switch IPv4 address setting is set to DHCP client.
- **IPv6 DHCP Client Mode:** Displays if your switch IPv6 address setting is set to DHCP client.

Automatic Network Features	
IPv4 DHCP Client Mode:	Disabled
IPv6 DHCP Client Mode:	Disabled

System

System Management

Set your system information

System > System Management

This section explains how to assign a name, location, and contact information for the switch. This information helps in identifying each specific switch among other switches in the same local area network. Entering this information is optional.

1. Log into your switch management page (see "[Access your switch management page](#)" on page 5).
2. Click on **System**, and click on **System Management**.
3. Review the settings. When you have completed making changes, click **Apply** to save the settings.
 - **System Description** - Specifies the Switch model. You cannot change this parameter.
 - **System Object ID** - Indicates the unique SNMP MIB object identifier that identifies the switch model. You cannot change this parameter.
 - **System Name** - Specifies a name for the switch, the name is optional and may contain up to 15 characters.
 - **System Location** - Specifies the location of the switch. The location is optional and may contain up to 30 characters.
 - **System Contact** - Specifies the name of the network administrator responsible for managing the switch. This contact name is optional and may contain up to 30 characters.

System Setting	
System Description:	
System Object ID:	1.3.6.1.4.1.28866.2.40
System Name:	<input type="text"/>
System Location:	<input type="text"/>
System Contact:	<input type="text"/>

4. Click **Apply**.



5. At the bottom of the left hand panel, click **Save**.

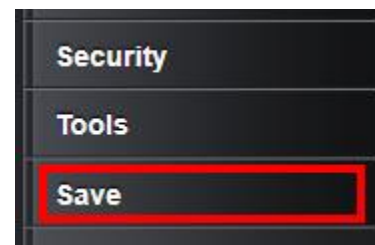

6. Select the Config you would like to save the settings to, click **Save Settings to Flash**, then click **OK**.

Note: This step saves all configuration changes to the NV-RAM to ensure that if the switch is rebooted or power cycled, the configuration changes will still be applied.

Save Settings to Flash		
Config File:	<input type="text" value="Config 1"/>	<input checked="" type="checkbox"/> startup-config
Note: The switch will stop responding while saving the current configuration to flash.		
<input type="button" value="Save Settings to Flash"/>		

L3 Feature

IPv4 Interface

System > L3 Feature > IPv4 Interface

This section allows you to change your switch IPv4 address settings and additionally create and assign the aforementioned address to VLANs. Typically, the IP address settings should be changed to match your existing network subnet in order to access the switch management page on your network.

Default Switch IPv4 Address: 192.168.10.200

Default Switch IPv4 Subnet Mask: 255.255.255.0

1. Log into your switch management page (see "[Access your switch management page](#)" on page 5).
2. Click on **System**, **L3 Feature**, and then **IPv4 Interface**.
3. To create a new entry per VLAN, type the VLAN number you would like to create, then click **Add**. To view a specific VLAN ID's configuration, enter the VLAN ID into the **Interface VLAN** field and then click **Find**.
4. To change the IPv4 IP address associated with a specific VLAN, click on **Edit** within the lower table.

IPv4 Interface

Interface VLAN (1-4094)

Interface Table

Total Entries : 1

Interface	State	IP Address	Link Status	Action
vlan1	Enabled	192.168.14.204/255.255.255.0 Manual	Up	<input type="button" value="Edit"/>

Page 1/1 Page

5. Review the settings. When you have completed making changes, click **Apply** to save the settings.

- **Interface:** Displays the VLAN that is currently being configured.
- **State:** Select **Enabled** to enable this VLAN, and **Disabled** to disable this VLAN.
- **Get IP From:** Select **Static** to statically assign an IP address and subnet mask, select **DHCP** to automatically request one from your networks DHCP server.
 - **IP Address:** Enter the new switch IP address you would like to statically assign. (e.g. 192.168.200.200)
 - **Subnet Mask:** Enter the new switch subnet mask. (e.g. 255.255.255.0)

Status Settings

Interface	vlan1
State	Enabled ▾

IP Settings

Get IP Form	Static ▾
IP Address	<input type="text" value="192"/> . <input type="text" value="168"/> . <input type="text" value="14"/> . <input type="text" value="204"/>
Subnet Mask	<input type="text" value="255"/> . <input type="text" value="255"/> . <input type="text" value="255"/> . <input type="text" value="0"/>

6. At the bottom of the left hand panel, click **Save**.
7. Select the Config you would like to save the settings to, click **Save Settings to Flash**, then click **OK**.

Note: This step saves all configuration changes to the NV-RAM to ensure that if the switch is rebooted or power cycled, the configuration changes will still be applied.

Save Settings to Flash

Config File:	Config 1 ▾	<input checked="" type="checkbox"/> startup-config
--------------	------------	--

Note: The switch will stop responding while saving the current configuration to flash.

IPv4 ARP Aging Time

System > L3 Feature > IPv4 ARP Aging Time

This section allows you to set the timeout for the switch's ARP Table per each configured VLAN.

1. Log into your switch management page (see "[Access your switch management page](#)" on page 5).
2. Click on **System, L3 Feature**, and then **IPv4 ARP Aging Time**.
3. Click on **Edit** to change the value, then click **Apply**.

ARP Aging Time		
Total Entries : 1		
Interface Name	Timeout	Action
vlan1	20	Edit

Page 1/1 [First Page](#) [Previous Page](#) [Next Page](#) [Last Page](#) Page [GO](#)

4. At the bottom of the left hand panel, click **Save**.
5. Select the Config you would like to save the settings to, click **Save Settings to Flash**, then click **OK**.

Note: This step saves all configuration changes to the NV-RAM to ensure that if the switch is rebooted or power cycled, the configuration changes will still be applied.

Save Settings to Flash		
Config File:	<input type="text" value="Config 1"/>	<input checked="" type="checkbox"/> startup-config

Note: The switch will stop responding while saving the current configuration to flash.

[Save Settings to Flash](#)

IPv4 Static ARP

System > L3 Feature > IPv4 Static ARP

This section allows you to statically set ARP entries per each configured VLAN.

1. Log into your switch management page (see "[Access your switch management page](#)" on page 5).
2. Click on **System, L3 Feature**, and then **IPv4 Static ARP**.
3. To add a static ARP entry, fill out the following fields and then press **Apply**. To delete an entry, press **Delete** in the lower table.
 - **IP Address:** enter the IP address you would like to statically set to the ARP table.
 - **Hardware Address:** enter the MAC address that you would like to assign to the IP entered above.

Static ARP	
IP Address	<input type="text" value="."/> . <input type="text" value="."/> . <input type="text" value="."/> . <input type="text" value="."/>
Hardware Address	<input type="text" value="00-84-57-00-00-00"/>
Apply	

Static ARP Table					
Total Entries : 1					
Interface Name	IP Address	Hardware Address	Aging Time	Type	Action
vlan1	192.168.14.114	EC:0E:C4:12:B9:C1	20	Dynamic	Delete

Page 1/1 [First Page](#) [Previous Page](#) [Next Page](#) [Last Page](#) Page [GO](#)

4. At the bottom of the left hand panel, click **Save**.
5. Select the Config you would like to save the settings to, click **Save Settings to Flash**, then click **OK**.

Note: This step saves all configuration changes to the NV-RAM to ensure that if the switch is rebooted or power cycled, the configuration changes will still be applied.

IPv4 Static/Default Route

System > L3 Feature > IPv4 Static/Default Route

This section allows you to set your switch's IPv4 routing table default, or specify a static route.

1. Log into your switch management page (see "[Access your switch management page](#)" on page 5).
2. Click on **System**, **L3 Feature**, and then **IPv4 Static/Default Route**.
3. Review the settings. When you have completed making changes, click **Apply** to save the settings, click **Delete** to delete the routing table entry.
 - **Default Route:** Check this box to apply this route as the default, uncheck the box to specify the following:
 - **IP Address:** Enter the IP address for this routing entry. (e.g. 192.168.200.200)
 - **Mask:** Enter the subnet mask for this routing entry. (e.g. 255.255.255.0)
 - **Next Hop IP Address:** Enter the next hop for the routing entry. (e.g. 192.168.20.200)
 - **Backup Status:** Specify if this routing entry is to be the **Primary** or **Backup** entry.

IPv4 Static/Default Route

IPv4 Static/Default Route

IP Address	<input type="text"/>	<input type="text"/>	<input type="text"/>	<input type="text"/>	<input checked="" type="checkbox"/> Default Route
Mask	<input type="text"/>	<input type="text"/>	<input type="text"/>	<input type="text"/>	
Next Hop IP Address	<input type="text"/>	<input type="text"/>	<input type="text"/>	<input type="text"/>	
Backup Status	<input type="text" value="Please Select"/>				

Route Table

Total Entries : 0

IP Address	Mask	Next Hop	Backup Status	Interface Name	Action
<< Table is empty >>					

Page 0/0 Page

4. At the bottom of the left hand panel, click **Save**.

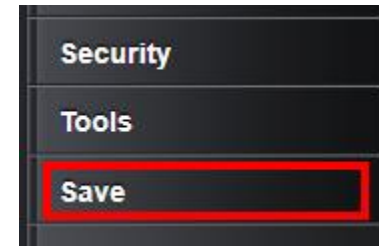

5. Select the Config you would like to save the settings to, click **Save Settings to Flash**, then click **OK**.

Note: This step saves all configuration changes to the NV-RAM to ensure that if the switch is rebooted or power cycled, the configuration changes will still be applied.

Save Settings to Flash

Config File:	<input type="text" value="Config 1"/>	<input checked="" type="checkbox"/> startup-config
--------------	---------------------------------------	--

Note: The switch will stop responding while saving the current configuration to flash.

Set your IPv6 settings

System > L3 Feature > IPv6 Interface

Internet Protocol version 6 (IPv6) is a new IP protocol designed to replace IP version 4 (IPv4). The IPv6 address protocol meets the current requirements of new applications and the never ending growth of the Internet. The IPv6 address space makes more addresses available but it must be approached with careful planning. Successful deployment of IPv6 can be achieved with existing IPv4 infrastructures. With proper planning and design, the transition between IP version 4 and 6 is possible today as well.

Use the **IPv6 Interface** page to configure the IPv6 network interface, which is the logical interface used for in-band connectivity with the switch via all of the switch's front-panel ports. The configuration parameters associated with the switch's network interface do not affect the configuration of the front-panel ports through which traffic is switched or routed.

1. Log into your switch management page (see "[Access your switch management page](#)" on page 5).
2. Click on **System, L3 Feature**, and then **IPv6 Interface**.
3. To create a new entry per VLAN, type the VLAN number you would like to create, then click **Add**. To view a specific VLAN ID's configuration, enter the VLAN ID into the **Interface VLAN** field and then click **Find**.
4. To change the IPv6 IP address associated with a specific VLAN, click on **Detail** within the lower table.

IPv6 Interface

Interface VLAN (1-4094)

Interface Table

Total Entries : 1

Interface	State	Link Status	Action
vlan1	Disabled	Down	<input type="button" value="Detail"/>

Page 1/1 Page

5. Review the settings. When you have completed making changes, click **Apply** to save the settings.

- **Interface:** Displays the VLAN that is currently being configured.
- **State:** Select **Enabled** to enable IPv6 on this VLAN, and **Disabled** to disable on this VLAN.

Status Settings

Interface	vlan1
State	<input type="button" value="Enabled"/>

- **DHCPv6 Client:** Select **Enabled** to automatically obtain the IPv6 address from the DHCP server on the network, select **Disabled** to manually specify an IPv6 Address.
- **Rapid Commit:** You can configure the switch to support the DHCPv6 Rapid Commit option (DHCPv6 option 14). The server and client then use a two-message exchange (Solicit and Reply) to configure clients, rather than the default four-message exchange (Solicit, Advertise, Request, and Reply). The two-message exchange provides faster client configuration, and is beneficial in environments in which networks are under a heavy load.
- **IPv6 Address:** Enter the full IPv6 address you would like to specify for this connection.

IP Settings

DHCPv6 Client State	<input type="button" value="Enabled"/> <input type="checkbox"/> Rapid Commit
IPv6 Address	<input type="text"/>

- **NS Retransmit Time:** A constant that defines a nonzero number of seconds between periodic reauthentication of the client. The field is 1~3600 seconds. The default setting is 1 second.

NS Retransmit Time

NS Interval sec (1-3600)

- **Delete:** Click **Delete** to delete this entry.

IPv6 Interface Table

Total Entries : 1

Address Type	IPv6 Address	Action
Link-Local Address	FE80::8226:89FF:FE3C:C090/64	<input type="button" value="Delete"/>

Page 1/1 Page

6. At the bottom of the left hand panel, click **Save**.

7. Select the Config you would like to save the settings to, click **Save Settings to Flash**, then click **OK**.

Note: This step saves all configuration changes to the NV-RAM to ensure that if the switch is rebooted or power cycled, the configuration changes will still be applied.

Save Settings to Flash

Config File: startup-config

Note: The switch will stop responding while saving the current configuration to flash.

Add IPv6 neighbors

System > L3 Feature > IPv6 Neighbor

This settings allows you to manually define IPv6 supported neighboring devices on your network.

1. Log into your switch management page (see "[Access your switch management page](#)" on page 5).
2. Click on **System**, **L3 Feature**, and then **IPv6 Neighbor**.
3. Review the settings. When you have completed making changes, click **Apply** to save the settings.
 - **Neighbor IPv6 Address:** Specifies the neighbor IPv6 address.
 - **Link Layer MAC Address:** Specifies the link layer MAC address.
 Click **Add** to save the entry to the list.

IPv6 Neighbor Settings

Neighbor IPv6 Address: *

Link Layer MAC Address *

- You can type in the specific address and click **Find** to find the entry to modify or click **Delete** or delete the address. If the entries span multiple pages, you can navigate page number in the **Page** field and click **Go** or you can click **First**, **Previous**, **Next**, and **Last Page** to navigate the pages.

IPv6 Neighbor Settings

Neighbor IPv6 Address	Link Layer MAC Address	State	Action
* <input type="text"/>	* <input type="text"/>	All <input type="text"/>	<input type="button" value="Find"/> <input type="button" value="Delete"/>

Page 0/0 Page

4. At the bottom of the left hand panel, click **Save**.

The screenshot shows a vertical navigation menu with three items: 'Security', 'Tools', and 'Save'. The 'Save' button is highlighted with a red rectangular border.

5. Select the Config you would like to save the settings to, click **Save Settings to Flash**, then click **OK**.

Note: This step saves all configuration changes to the NV-RAM to ensure that if the switch is rebooted or power cycled, the configuration changes will still be applied.

Save Settings to Flash

Config File: startup-config

Note: The switch will stop responding while saving the current configuration to flash.

Configure IPv6 Routing Table

System > L3 Feature > IPv6 Static/Default Route

This section allows you to set your switch's IPv6 routing table default, or specify a static route.

- Log into your switch management page (see "[Access your switch management page](#)" on page 5).
- Click on **System**, **L3 Feature**, and then **IPv6 Static/Default Route**.
- Review the settings. When you have completed making changes, click **Apply** to save the settings, click **Delete** to delete the routing table entry.
 - Default Route:** Check this box to apply this route as the default, uncheck the box to specify the following:
 - IPv6 Address/Prefix length:** Enter the IP address for this routing entry.
 - Interface VLAN:** Specify the VLAN ID to apply this route to.
 - Next Hop IPv6 Address:** Enter the next hop for the routing entry.
 - Backup Status:** Specify if this routing entry is to be the **Primary** or **Backup** entry.

IPv6 Static/Default Route

IPv6 Address/Prefix len	<input type="text" value="2013::1/64"/>	<input checked="" type="checkbox"/> Default Route
Interface VLAN	<input type="text" value=""/>	(1-4094)
Next Hop IPv6 Address	<input type="text" value="3FE1::1"/>	
Backup Status	<input type="text" value="Please Select"/>	

Route Table

Total Entries : 1

IPv6 Address/Prefix Length	Next Hop	Interface Name	Protocol	Action
::/0	FE80::8	vlan1	S	<input type="button" value="Delete"/>

Page 1/1 Page

Note: C - Connected, S - Static, - Selected Route, * - Valid Route

4. At the bottom of the left hand panel, click **Save**.



5. Select the Config you would like to save the settings to, click **Save Settings to Flash**, then click **OK**.

Note: This step saves all configuration changes to the NV-RAM to ensure that if the switch is rebooted or power cycled, the configuration changes will still be applied.

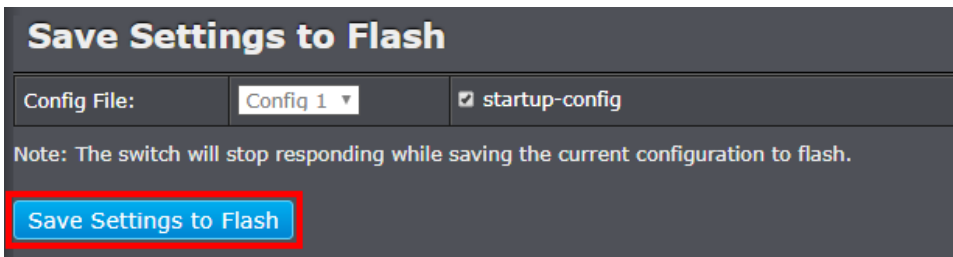

DNS

Set your DNS server settings

System > DNS

This setting allows you to configure your IPv4/IPv6 DNS server settings for the purpose of resolving hostnames. For example, when specifying your SNTP server time settings via domain name, the switch will not be able to resolve the SNTP domain name specified until you configure the switch DNS server setting.

1. Log into your switch management page (see "[Access your switch management page](#)" on page 5).
2. Click on **System**, and click on **DNS**.
3. Enter your **DNS IPv4 Server** address and/or **DNS IPv6 Server** address in the provided fields then click **Apply**.

 A screenshot of the 'DNS Server Settings' form. The title is 'DNS Server Settings'. There are two input fields: 'DNS IPv4 Server' and 'DNS IPv6 Server'. The 'DNS IPv4 Server' field contains the IP address '0.0.0.0' and is highlighted with a red rectangular border. The 'DNS IPv6 Server' field is empty.

4. At the bottom of the left hand panel, click **Save**.

5. Select the Config you would like to save the settings to, click **Save Settings to Flash**, then click **OK**.

Note: This step saves all configuration changes to the NV-RAM to ensure that if the switch is rebooted or power cycled, the configuration changes will still be applied.

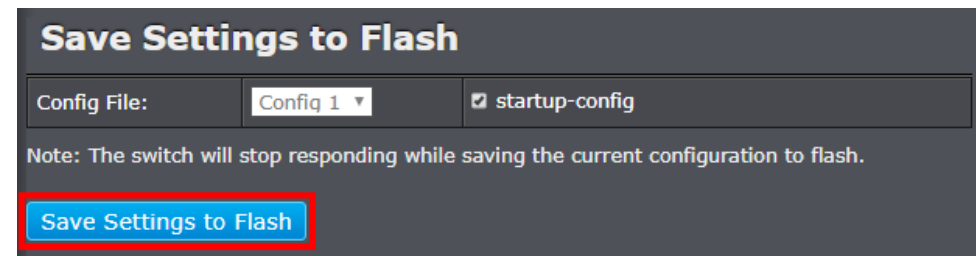

IP Access List

Restrict access to switch management page

System > IP Access List

This section allows you to define or restrict access to the switch management page to a list of specific IP addresses.

1. Log into your switch management page (see "[Access your switch management page](#)" on page 5).
2. Click on **System**, and click on **IP Access List**.
3. Review the settings.

First, enter the IPv4 or IPv6 address to allow access and click **Add** for each entry.

IP Address Settings

IP Address: [] . [] . [] . [] IPv4
 IPv6

Add

For each entry, the access list will populate. You can click **Delete** next to the entry to delete the entry or **Delete All** to delete all entries in the table.

IP Access List table			Delete All
Index	Accessible IP	Action	
1	192.168.10.15	Delete	

When you have completed entering the IPv4 and IPv6 address entries, click the **IP Restriction Status** drop-down list at the top and select **Enabled**, then click **Apply**.

IP Access List

IP Restriction Status: **Disabled** ▼

4. At the bottom of the left hand panel, click **Save**.

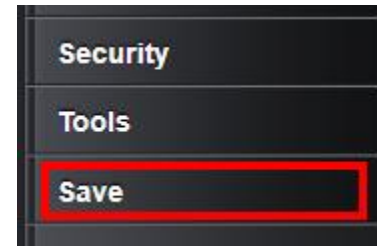

5. Select the Config you would like to save the settings to, click **Save Settings to Flash**, then click **OK**.

Note: This step saves all configuration changes to the NV-RAM to ensure that if the switch is rebooted or power cycled, the configuration changes will still be applied.

Save Settings to Flash

Config File: **Config 1** ▼ startup-config

Note: The switch will stop responding while saving the current configuration to flash.

Save Settings to Flash

Administration

Change administrator password and add accounts

System > Administration

This section explains how to change the administrator password create additional administrative user accounts for access to the switch management page.

1. Log into your switch management page (see "[Access your switch management page](#)" on page 5).
2. Click on **System**, and click on **Administration**.
3. Review the settings.

To change the administrator password, in the "admin" entry in the table, click on **Modify**. **Note:** This default administrator account cannot be deleted.

Administration table			
Index	User Name	Password	Action
1	admin	*****	Modify

In the **Password** field, enter the new password and enter the new password again the **Confirm Password** field to verify. Then, click **Apply**.

Note: The password consists of up to 20 alphanumeric characters.

Modify Administration	
Entry number:	<input type="text" value="1"/>
User Name:	<input type="text" value="admin"/>
Password:	<input type="password"/>
Confirm Password:	<input type="password"/>

To create additional administrative user accounts:

- **User Name:** Enter the user name of the new account.
- **Password:** Enter the password for the new account and enter the password again in the **Confirm Password** field to verify. Then, click **Add** to add to the table. For additional user accounts, you will be provided the option to **Modify** or **Delete** to remove the account.

Note: The password consists of up to 20 alphanumeric characters.

Administration Settings	
User Name:	<input type="text"/> (Maximum length is 12)
Password:	<input type="password"/> (Maximum length is 23)
Confirm Password:	<input type="password"/>
Add	

4. At the bottom of the left hand panel, click **Save**.

5. Select the Config you would like to save the settings to, click **Save Settings to Flash**, then click **OK**.

Note: This step saves all configuration changes to the NV-RAM to ensure that if the switch is rebooted or power cycled, the configuration changes will still be applied.

Save Settings to Flash	
Config File:	<input type="text" value="Config 1"/> <input checked="" type="checkbox"/> startup-config
Note: The switch will stop responding while saving the current configuration to flash.	
Save Settings to Flash	

Timeout

Change web idle login timeout settings

System > Timeout

This section explains how to modify the switch management page idle timeout settings.

1. Log into your switch management page (see "[Access your switch management page](#)" on page 5).
2. Click on **System**, and click on **Timeout**.
3. Review the settings. Click **Apply** to save changes.
 - **Web Idle Timeout** - Enter the idle period in minutes, when the switch will automatically log out a user from the switch management page.

Timeout Settings	
Web Idle Timeout:	<input type="text" value="10"/> Min.(3-60)
<input type="button" value="Apply"/>	

4. At the bottom of the left hand panel, click **Save**.
5. Select the Config you would like to save the settings to, click **Save Settings to Flash**, then click **OK**.

Note: This step saves all configuration changes to the NV-RAM to ensure that if the switch is rebooted or power cycled, the configuration changes will still be applied.

Save Settings to Flash		
Config File:	<input type="text" value="Config 1"/>	<input checked="" type="checkbox"/> startup-config
Note: The switch will stop responding while saving the current configuration to flash.		
<input type="button" value="Save Settings to Flash"/>		

System Time

Set the switch date and time

System > System Time

1. Log into your switch management page (see "[Access your switch management page](#)" on page 5).
2. Click on **System**, and click on **System Time**.
3. Review the settings. Click **Apply** to save changes.
 - **Clock Mode** - Displays if system time and date is set manually **Local Time** or obtained automatically from a network time server **SNTP**.
 - **Current Time** – Displays the current system time and date.
 - **Time Zone** – Displays the current system time zone.

Clock Mode:	Local Time
Current Time:	2 Jan 2009 06:18:23
Time Zone:	

- **Clock Mode:** Select **Local Time** to manually configure your date and time settings or select **SNTP** to configure your switch to automatically obtain settings from a network time server.

Date/Time Settings	
Clock Mode:	<input type="text" value="Local Time"/>

- **Local Time** – Allows you to manually set the time settings. If selecting this option, under **Local Time Settings**, manually enter your date and time settings.
 - **Date Settings** – Enter your date settings (YYYY/MM/DD).
 - **Time Settings** – Enter your time settings (HH:MM:SS)

Local time Settings	
Date Settings:	2009 / 1 / 2 (YYYY:MM:DD)
Time Settings:	06 : 18 : 23 (HH:MM:SS)

- **SNTP** – Allows you to configure your switch to pull time and date settings automatically from a network time server. If selecting this option, under **Simple Network Time Protocol (SNTP) Settings**, enter your time server settings.

Note: Please note that in order for the switch to communicate to Internet SNTP time servers, the switch must have valid IPv4/IPv6 address settings including a default gateway address for Internet access. Additionally, if using a domain name, the switch must be configured with valid DNS server settings in order to resolve host/domain names.

- **SNTP Primary Server** – Enter the primary network time server IPv4 address, IPv6 address, or Domain Name.
- **SNTP Secondary Server** – Enter the secondary network time server IPv4 address, IPv6 address, or Domain Name.
- **SNTP Poll Interval** – Enter the interval time when your switch will update the time and date settings with the time server.
- **Time Zone** – Click the drop-down list to select your time zone. Additionally, you can set your Daylight Savings Time.

Simple Network Time Protocol (SNTP) Settings	
SNTP Primary Server:	0 . 0 . 0 . 0 IPv4
SNTP Secondary Server:	0 . 0 . 0 . 0 IPv4
SNTP Poll Interval:	1 Min.(1-60)
Time Zone:	(GMT-08:00) Pacific Time (US & Canada),Tijuana

- **Additional Time Parameters** – Allows you to configure additional Daylight Saving Time parameters.
 - **Daylight Savings Time Status:** Click the drop-down list to enable or disable Daylight Savings.
 - **From:** Set the daylight savings start date and time.

- **To:** Set the daylight savings end date and time.
- **DST Offset:** Click the drop-down list to set the time offset based on respective time zone.

Additional Time Parameters	
Daylight Saving Time Status:	Enabled
From:	January 01 00 00 (Month:Day:HH:MM)
To:	January 01 00 00 (Month:Day:HH:MM)
DST Offset:	1 hr

4. At the bottom of the left hand panel, click **Save**.

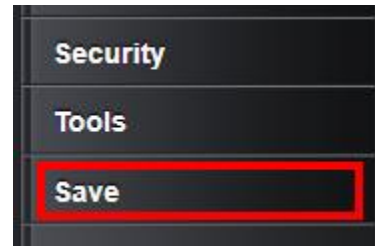

5. Select the Config you would like to save the settings to, click **Save Settings to Flash**, then click **OK**.

Note: This step saves all configuration changes to the NV-RAM to ensure that if the switch is rebooted or power cycled, the configuration changes will still be applied.

Save Settings to Flash	
Config File:	Config 1 <input checked="" type="checkbox"/> startup-config
Note: The switch will stop responding while saving the current configuration to flash.	
Save Settings to Flash	

SSL

Enable HTTPS/SSL (Secure Socket Layer) management access

System > SSL

By default, your switch management page can be accessed using standard web HTTP protocol which is unsecure. Enabling HTTPS/SSL management access allows access to the switch management page using secure encrypted communication which prevents unauthorized users from intercepting user name and password credentials. Typically, the switch is accessed within the local network only by system administrators which does not necessarily require additional security. It is recommended to only enable this feature, if allowing switch management access from other networks or over the Internet.

Note: Once HTTPS/SSL management access is enabled, HTTP management access will be disabled forcing all access to the switch management page using secure encryption communication only.

1. Log into your switch management page (see "[Access your switch management page](#)" on page 5).
2. Click on **System**, and click on **SSL**.
3. Review the settings. Click **Apply** to save changes.
 - **SSL Status:**
 - **Enabled** – Enables HTTPS/SSL management access and disables HTTP unsecured mode.
 - **Disabled** – Disabled HTTPS/SSL management access and enabled HTTP unsecured mode. (Default setting).



If enabling SSL management access, you will need to access the switch management page using **HTTPS** instead of **HTTP**. (e.g. <https://192.168.10.200>)



Click **Continue, Proceed to this website**, and accept the certificate if prompted.

 **Continue to this website (not recommended).**

4. At the bottom of the left hand panel, click **Save**.

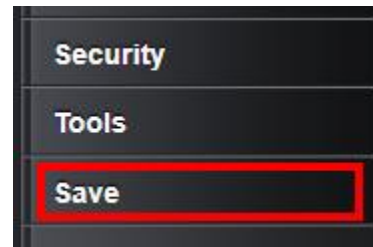

5. Select the Config you would like to save the settings to, click **Save Settings to Flash**, then click **OK**.

Note: This step saves all configuration changes to the NV-RAM to ensure that if the switch is rebooted or power cycled, the configuration changes will still be applied.

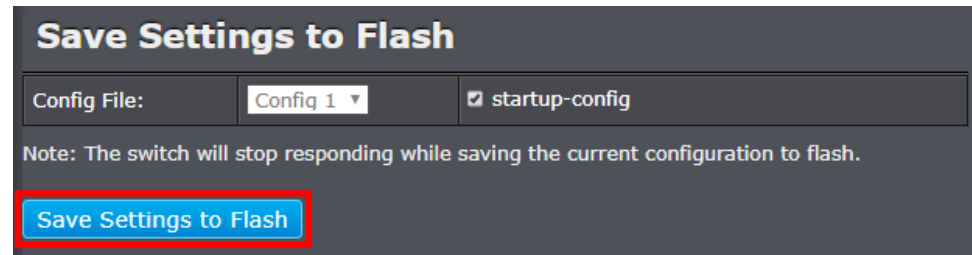

SSH

Enable SSH (Secure Shell) management access

System > SSH

1. Log into your switch management page (see "[Access your switch management page](#)" on page 5).
2. Click on **System**, and click on **SSH**.
3. Review the settings. Click **Apply** to save changes.
 - **SSH Status:**
 - **Enabled** – Enables SSH management access.
 - **Disabled** – Disabled SSH management access.
 - **Port:** Set the port number to use for SSH management access

SSH Settings

SSH Settings

SSH Status:

Port (1-65535):

4. At the bottom of the left hand panel, click **Save**.



5. Select the Config you would like to save the settings to, click **Save Settings to Flash**, then click **OK**.

Note: This step saves all configuration changes to the NV-RAM to ensure that if the switch is rebooted or power cycled, the configuration changes will still be applied.

Save Settings to Flash

Config File:

startup-config

Note: The switch will stop responding while saving the current configuration to flash.

Telnet

Enable Telnet management access

System > Telnet

1. Log into your switch management page (see "[Access your switch management page](#)" on page 5).
2. Click on **System**, and click on **Telnet**.
3. Review the settings. Click **Apply** to save changes.
 - **Telnet Status:**
 - **Enabled** – Enables Telnet management access.
 - **Disabled** – Disabled Telnet management access.
 - **Port:** Set the port number to use for Telnet management access

SSH Settings

SSH Settings

SSH Status:

Port (1-65535):

Apply

4. At the bottom of the left hand panel, click **Save**.



5. Select the Config you would like to save the settings to, click **Save Settings to Flash**, then click **OK**.

Note: This step saves all configuration changes to the NV-RAM to ensure that if the switch is rebooted or power cycled, the configuration changes will still be applied.

Save Settings to Flash

Config File:

Config 1 ▾

startup-config

Note: The switch will stop responding while saving the current configuration to flash.

Save Settings to Flash

DHCP Auto Configuration

Enable DHCP Auto Configuration

System > DHCP Auto Configuration

If you need to automatically update the switch configuration files via a remote server, the DHCP Auto Configuration feature is available for this purpose via the DHCP server. Your IP address settings must enable the DHCP client so that this feature can operate with your DHCP server.

1. Log into your switch management page (see "[Access your switch management page](#)" on page 5).
2. Click on **System**, and click on **DHCP Auto Configuration**.
3. Click the **Auto Configuration State** drop-down list and select **Enabled**. Click **Apply** to save changes.

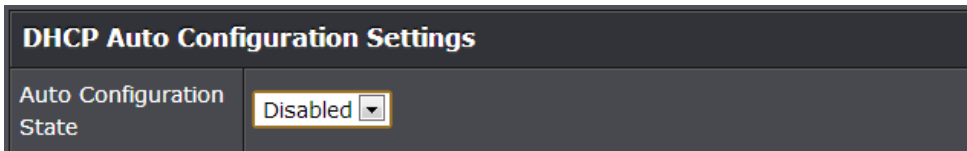

The screenshot shows the 'DHCP Auto Configuration Settings' section. The 'Auto Configuration State' is currently set to 'Disabled' in a dropdown menu.

4. At the bottom of the left hand panel, click **Save**.



The screenshot shows the left hand panel with three buttons: 'Security', 'Tools', and 'Save'. The 'Save' button is highlighted with a red border.

5. Select the Config you would like to save the settings to, click **Save Settings to Flash**, then click **OK**.

Note: This step saves all configuration changes to the NV-RAM to ensure that if the switch is rebooted or power cycled, the configuration changes will still be applied.

Save Settings to Flash

Config File: startup-config

Note: The switch will stop responding while saving the current configuration to flash.

Save Settings to Flash

System Log

View and setup your switch logging

System > System Log

The system log is designed to monitor the operation the switch by recording the event messages it generates during normal operation. These events may provide vital information about system activity that can help in the identification and solutions of system problems.

1. Log into your switch management page (see "[Access your switch management page](#)" on page 5).
2. Click on **System**, and click on **System Log**.
3. Review the settings. Click **Apply** to save changes.
 - **Time Stamp**
 - **Enable** - Each event message recorded in the log will have a time stamp.
 - **Disable** - No time stamp will be included with the event messages.
 - **Message Buffered Size** - Enter the message buffer size. (Range: 1-200)
 - **Syslog Status** - Allows you to send device logging to an external log (Syslog) server for troubleshooting or monitoring.
 - **Enable** – Enable syslog and in the **Syslog Server IP** section, enter the IPv4 or IPv6 address of the external syslog server to send logging.
 - **Disable** – Disable syslog functionality.
 - **Facility** - Click the drop-down list and which facility to store the logging. (Options: local0 – local7)
Note: You can define the facility to store logging on your external syslog server. This helps to ensure you have separate logging sections for different devices.
 - **Logging Level** – Click the drop-down list to select what level of event messages that will be logged.
 - **1 Alert** - Action must be taken immediately.
 - **2 Critical** - Critical conditions are displayed.
 - **3 Warning** - Warning conditions are displayed.
 - **4 Info** - Informational messages are displayed.

System Log Settings

System Log Settings	
Time Stamp:	Enabled ▾
Message Buffered Size:	50 (1-256)
Syslog Status:	Disabled ▾
Syslog Server IP:	0 . 0 . 0 . 0 <input type="radio"/> IPv4 <input type="text"/> <input type="radio"/> IPv6
Facility:	local0 ▾
Logging Level:	Warning ▾
<input type="button" value="Apply"/>	

4. At the bottom of the left hand panel, click **Save**.

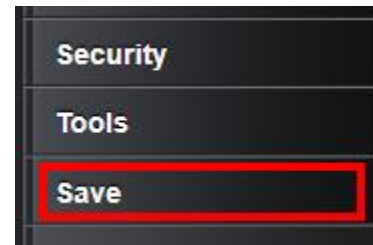

5. Select the Config you would like to save the settings to, click **Save Settings to Flash**, then click **OK**.

Note: This step saves all configuration changes to the NV-RAM to ensure that if the switch is rebooted or power cycled, the configuration changes will still be applied.

Save Settings to Flash

Config File:	Config 1 ▾	<input checked="" type="checkbox"/> startup-config
Note: The switch will stop responding while saving the current configuration to flash.		
<input type="button" value="Save Settings to Flash"/>		

SNMP

Settings

System > SNMP > Settings

You can manage a switch by viewing and configuring the management information base (MIB) objects on the device with the Simple Network Management Program (SNMP). This chapter describes how to configure SNMP. A Group Name, IP address of the switch and at least one community string is the minimum required to manage the switch using SNMP.

The SNMP Engine ID screen allows network managers to define the SNMP Engine ID or to assign the default Engine ID to SNMP.

Note: If you disable the SNMP on the switch, the switch will not be manageable via SNMP using MIBs.

1. Log into your switch management page (see "[Access your switch management page](#)" on page 5).
2. Click on **System**, click on **SNMP**, and click on **Settings**.
3. Review the settings. Click **Apply** to save changes.

- **SNMP Agent Status:** Click the drop-down list to one of the following options.
 - **Enabled** - When you enable this parameter, the SNMP agent is active. You can manage the switch with SNMP network management software and the switch's private MIB.
 - **Disabled** - When you enable this parameter, the SNMP agent is inactive.

Status Settings	
SNMP Agent Status:	Enabled ▾

- **Engine ID (10-64 Hex Characters)** – Enter the local device Engine ID. The field value is a hexadecimal string. Each byte in hexadecimal character strings is two hexadecimal digits. The Engine ID must be defined before SNMP is enabled.
- **Reset to Default** – Use the device-generated Engine ID (**Reset to Default** will override any entry in the **Engine ID** field).

SNMP Engine ID Settings	
Engine ID:	800070c203000102030405 *

4. At the bottom of the left hand panel, click **Save**.

Security
Tools
Save

5. Select the Config you would like to save the settings to, click **Save Settings to Flash**, then click **OK**.

Note: This step saves all configuration changes to the NV-RAM to ensure that if the switch is rebooted or power cycled, the configuration changes will still be applied.

Save Settings to Flash		
Config File:	Config 1 ▾	<input checked="" type="checkbox"/> startup-config
Note: The switch will stop responding while saving the current configuration to flash.		
Save Settings to Flash		

View

System > SNMP > View

The SNMP View table specifies the MIB object access criteria for each View Name. If the View Name is not specified on this page, then it has access to all MIB objects. You can specify specific areas of the MIB that can be accessed or denied based on the entries in this table. You can create and delete entries in the View table.

1. Log into your switch management page (see "[Access your switch management page](#)" on page 5).
2. Click on **System**, click on **SNMP**, and click on **View**.
3. Review the settings.

Creating SNMP View Table Entries

This procedure explains how to create entries in the SNMP View Table.

- Enter the **View Name**. This entry must be pre-defined on the SNMP User/Group page.
- Enter the **Subtree OID**.
- Enter "1" for the **OID Mask**.
- Enter the **View Type**. Choose from the following options, and then click **Add**.
 - **Included:** This selection allows the specified MIB object to be included in the view.
 - **Excluded:** This selection blocks the view of the specified MIB object.

SNMP View Settings	
View Name:	<input type="text"/> *
	(32 characters limit)
Subtree OID:	<input type="text"/> *
OID Mask:	<input type="text"/> *
View Type:	included ▾

Modifying SNMP View Table Entries

If you need to modify an entry in the View Table page, you must first delete the entry and then re-enter it.

Deleting SNMP View Table Entries

In the **Action** column of the table, click **Delete** for the View table entry that you want to remove.

SNMP View Table				
View Name	Subtree OID	OID Mask	View Type	Action
ReadWrite	1	1	Included	Delete

4. At the bottom of the left hand panel, click **Save**.

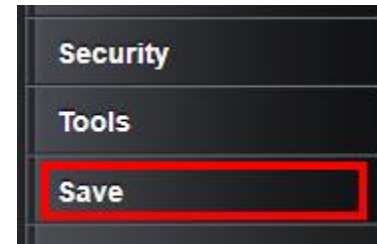

5. Select the Config you would like to save the settings to, click **Save Settings to Flash**, then click **OK**.

Note: This step saves all configuration changes to the NV-RAM to ensure that if the switch is rebooted or power cycled, the configuration changes will still be applied.

Save Settings to Flash		
Config File:	Config 1 ▾	<input checked="" type="checkbox"/> startup-config
Note: The switch will stop responding while saving the current configuration to flash.		
Save Settings to Flash		

Group

System > SNMP > Group

The SNMP View Names are defined in the SNMP Group Access table and are based on the User and Group Names

1. Log into your switch management page (see "[Access your switch management page](#)" on page 5).
2. Click on **System**, click on **SNMP**, and click on **Group**.
3. Review the settings.

Creating SNMP View Names

Before you can create an SNMP View name, you must define a Group Name using the SNMP User/Group page.

- Enter the **Group Name**. This entry must be pre-defined on the SNMP User/Group page.
- Enter the **Read View Name**. This name is an optional field. It can be up to 31 characters in length.
- Enter the **Write View Name**. This name is an optional field. It can be up to 31 characters in length.
- Enter the **Notify View Name**. This name is an optional field. It can be up to 31 characters in length.
- From the **Security Model** pull-down menu, select **v3**.
- Enter the **Security Level** from the pull-down menu. The selection options are:
 - **NoAuthNoPriv**: This selection is the appropriate selection when no **Auth-Protocol** or **Priv-Protocol** (no encryption) are selected on the SNMP User/Group page.
 - **AuthNoPriv**: Choose this selection when encryption has been enabled but only the **Auth-Protocol** has a password assigned and the **Priv-Protocol** has been selected as **none** on the SNMP User/Group page.
 - **AuthPriv**: When the **Auth-Protocol** or **Priv-Protocol** have been enabled, choose this selection.
- Click the **Add** button.

SNMP Group Access Settings	
Group Name:	<input type="text"/> * (32 characters limit)
Read View Name:	<input type="text"/> (32 characters limit)
Write View Name:	<input type="text"/> (32 characters limit)
Notify View Name:	<input type="text"/> (32 characters limit)
Security Model:	v1 ▾
Security Level:	NoAuthNoPriv ▾

Modifying SNMP View Names

If you need to modify an entry in the SNMP Group Access page, you must first delete the entry and then re-enter it.

Deleting SNMP View Names

In the **Action** column of the table, click **Delete** for the **View Name** that you want to remove.

Note: The views corresponding to the **ReadOnly** and **ReadWrite** Group Names are default values and cannot be removed.

SNMP Group Access Table						
Group Name	Read View	Write View	Notify View	Security Model	Security Level	Action
ReadOnly	ReadWrite	---	ReadWrite	v1	NoAuthNoPriv	Delete
ReadOnly	ReadWrite	---	ReadWrite	v2c	NoAuthNoPriv	Delete
ReadWrite	ReadWrite	ReadWrite	ReadWrite	v1	NoAuthNoPriv	Delete
ReadWrite	ReadWrite	ReadWrite	ReadWrite	v2c	NoAuthNoPriv	Delete

4. At the bottom of the left hand panel, click **Save**.
5. Select the Config you would like to save the settings to, click **Save Settings to Flash**, then click **OK**.

User

System > SNMP > User

An SNMP User Name and Group Name definition is the basis for all the other SNMP tables. You can create and delete View Names by following the procedures in the following sections:

1. Log into your switch management page (see "[Access your switch management page](#)" on page 5).
2. Click on **System**, click on **SNMP**, and click on **User**.
3. Review the settings.

Creating SNMP User and Group Names

Note: There are no default User Names or Group Names defined for SNMP.

- Type a new **User Name**. Enter a name up to 32 characters in length.
- Type a new **Group Name**. Enter a name up to 32 characters in length.
- From the **SNMP Version** pull down menu, select **v3**. The **encryption** check-box becomes active.
 - Check the **encryption** check-box. The **Auth-Protocol**, **Priv-Protocol**, and associated password fields become active.
- Select one of the following choices for the **Auth-Protocol** field:
 - **MD5** - The MD5 authentication protocol. SNMP Users are authenticated with the MD5 authentication protocol after a message is received.
 - **SHA** - The SHA authentication protocol. Users are authenticated with the SHA authentication protocol after a message is received.
- Enter the password for the **Auth-Protocol**.
- Select one of the following choices for the **Priv-Protocol** field:
 - **DES** - Specifies DES encryption scrambles the SNMP data so that outside observers are prevented from seeing the data content.
 - **none** - Specifies no encryption is applied to SNMP data.

- Click **Add**. The new User Name and Group Name are displayed on the SNMP User/Group page.

SNMP User/Group Settings		
User Name:	<input type="text"/> *	(32 characters limit)
Group Name:	<input type="text"/> *	(32 characters limit)
SNMP Version:	v1 ▾	<input type="checkbox"/> encrypted
Auth-Protocol:	MD5 ▾	Password: <input type="text"/>
Priv-Protocol:	DES ▾	Password: <input type="text"/>

Modifying SNMP User and Group Names

If you need to modify an entry in the **SNMP User/Group** page, you must first delete the entry and then re-enter it.

Deleting SNMP User and Group Names

In the **Action** column of the table, click **Delete** for the **User Name** and **Group Name** that you want to remove.

SNMP User/Group Table					
User Name	Group Name	SNMP Version	Auth-Protocol	Priv-Protocol	Action
ReadOnly	ReadOnly	v1	None	None	Delete
ReadOnly	ReadOnly	v2c	None	None	Delete
ReadWrite	ReadWrite	v1	None	None	Delete
ReadWrite	ReadWrite	v2c	None	None	Delete

4. At the bottom of the left hand panel, click **Save**.
5. Select the Config you would like to save the settings to, click **Save Settings to Flash**, then click **OK**.

Community

System > SNMP > Community

A community string has attributes for controlling who can use the string and what the string will allow a network management station to do on the switch. The Web Management Utility does not provide any default community strings. You must first define an SNMP User and Group Name on the SNMP User/Group page and then define a Community Name on the SNMP Community Table page.

1. Log into your switch management page (see "[Access your switch management page](#)" on page 5).
2. Click on **System**, click on **SNMP**, and click on **Community**.
3. Review the settings.

Create SNMP Community Settings

- Enter a new **Community Name**. A name can be up to 32 characters in length.
- Enter a **User Name(View Policy)** that has been previously defined. This name must match one of the User Names displayed on the

Note: *SNMP User/Group* page. If you enter a user name that has not been pre-defined on the SNMP User/Group page, the Community entry is displayed, but the agent/manager communication fails.

- Click **Add**. The values of the new **Community Name** and **User Name** are displayed.

SNMP Community Settings	
Community Name:	<input type="text"/> *
	(32 characters limit)
User Name (View Policy):	<input type="text"/> *
	(32 characters limit)

Modify SNMP Community Settings

If you need to modify a Community Table entry, you must first delete the entry by using the procedure below and then re-enter it with the modification by creating a new Community table entry.

Delete SNMP Community Settings

- To delete a **Community Name**, click **Delete** next to the entry in the table that you want to remove.
- The deleted **Community Name** is no longer displayed in the Community table. No confirmation message is displayed.
- To delete all, click the **Delete All** button.

SNMP Community Table (Free Entries : 48, Total Entries : 2)		Delete All
Community Name	User Name(View Policy)	Action
private	ReadWrite	Delete
public	ReadOnly	Delete

Page 1/1 [First Page](#) [Previous Page](#) [Next Page](#) [Last Page](#) Page [GO](#)

4. At the bottom of the left hand panel, click **Save**.

5. Select the Config you would like to save the settings to, click **Save Settings to Flash**, then click **OK**.

Note: *This step saves all configuration changes to the NV-RAM to ensure that if the switch is rebooted or power cycled, the configuration changes will still be applied.*

Save Settings to Flash		
Config File:	<input type="text" value="Config 1"/>	<input checked="" type="checkbox"/> startup-config
Note: The switch will stop responding while saving the current configuration to flash.		
Save Settings to Flash		

Trap

System > SNMP > Trap

A Host IP address is used to specify a management device that needs to receive SNMP traps sent by the switch. This IP address is associated with the SNMP Version and a valid Community Name in the Host table of the switch.

1. Log into your switch management page (see "[Access your switch management page](#)" on page 5).
2. Click on **System**, click on **SNMP**, and click on **Trap**.
3. Review the settings.

Create Trap Host Table Entry

Use the following procedure to create a trap Host table entry:

- Enable trap management by selecting the radio button next to **Enabled** at the top of the page. By default, trap management is enabled.
- Enter the **Host IP Address** for the management device that is to receive the SNMP traps.
- Enter the **SNMP Version**, either **v1** or **v2c**, that is configured for the host management device.
- Enter a **Community Name** that you have defined previously in the SNMP Community table. The **Community Name** must correlate with one of the communities displayed on the SNMP Community Table page. If you enter a **Community Name** that has not been pre-defined, the Trap Host entry is displayed, but agent/manager communication fails.
- Click **Add**. The new host is added to the table.

Trap Management Global Settings

Trap Status: Enabled ▼

Apply

Add Host Table

Host IP Address: . . . IPv4

IPv6

SNMP Version: v1 ▼

Community Name/User Name: * (32 characters limit)

Add
Reset

Modify a Trap Host Table Entry

If you need to modify an SNMP Trap entry, you must first delete the entry by using the procedure below and then re-enter it with the modification by creating a new SNMP trap.

Delete a Trap Host Table Entry

To delete an entry in the host table, click **Delete** next to the entry in the table that you want to remove. The Host table entry is removed from the table. No confirmation message is displayed.

Trap Management Table			
Host Ip Address	SNMP Version	Community Name/User Name	Action
<< snmp trap management list is empty >>			

4. At the bottom of the left hand panel, click **Save**.
5. Select the Config you would like to save the settings to, click **Save Settings to Flash**, then click **OK**.

Note: This step saves all configuration changes to the NV-RAM to ensure that if the switch is rebooted or power cycled, the configuration changes will still be applied.

RMON

Settings

System > RMON > Settings

The RMON (Remote MONitoring) MIB is used with SNMP applications to monitor the operations of network devices. The Switch supports the four RMON MIB groups listed here:

- **Statistic** group— This group is used to view port statistics remotely with SNMP programs.
- **History** group— This group is used to collect histories of port statistics to identify traffic trends or patterns.
- **Event** group— This group is used with alarms to define the actions of the switch when packet statistic thresholds are crossed.
- **Alarm** group— This group is used to create alarms that trigger event log messages or SNMP traps when statistics thresholds are exceeded.

You can use your SNMP Network Management System (NMS) software and the RMON section of the MIB tree to view the RMON statistics, history and alarms associated with specific ports. Since RMON uses the SNMP agent for communicating with your NMS software, the SNMP Agent must be enabled and the SNMP feature must be configured on your switch. Since RMON works in conjunction with the SNMP agent, the SNMP agent must be enabled for the RMON feature to be active.

1. Log into your switch management page (see "[Access your switch management page](#)" on page 5).
2. Click on **System**, click on **RMON** and click on **Settings**.
3. Click the **RMON Status** drop-down list and select **Enabled** to enable RMON. Click **Apply** to save settings.



4. At the bottom of the left hand panel, click **Save**.

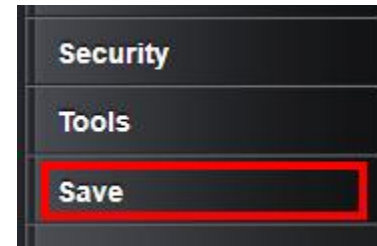

5. Select the Config you would like to save the settings to, click **Save Settings to Flash**, then click **OK**.

Note: This step saves all configuration changes to the NV-RAM to ensure that if the switch is rebooted or power cycled, the configuration changes will still be applied.

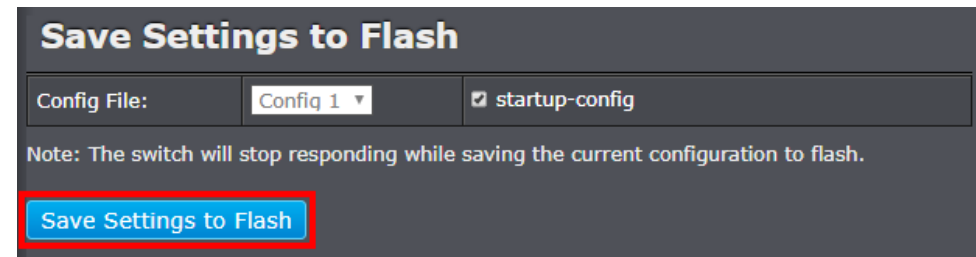

Statistics

System > RMON > Statistics

You can remotely view individual port statistics with RMON by using your SNMP NMS software and the RMON portion of the MIB tree.

1. Log into your switch management page (see "[Access your switch management page](#)" on page 5).
2. Click on **System**, click on **RMON**, and click on **Statistics**.
3. Review the settings.
 - **Index:** This parameter specifies the ID number of the new group. The range is 1 to 65535.
 - **Port:** This parameter specifies the port where you want to monitor the statistical information of the Ethernet traffic.
 - **Owner:** This parameter is used to identify the person who created an entry. It is primarily intended for switches that are managed by more than one person, and is an optional field.

Click **Add** to add the entry to the table.

Ethernet Statistics Settings	
Index:	<input type="text"/> * (1-65535)
Port:	<input type="text"/> *
Owner:	<input type="text"/> (32 characters limit)

In the list, you can click **Modify** to modify an entry or click **Delete** or delete the entry. If the entries span multiple pages, you can navigate page number in the **Page** field and click **Go** or you can click **First**, **Previous**, **Next**, and **Last Page** to navigate the pages.

Ethernet Statistics Table								
Index	Port	Drop Events	Octets	Packets	Broadcast Packets	Multicast Packets	Owner	Action
<< Table is empty >>								
Page 0/0 <input type="button" value="First Page"/> <input type="button" value="Previous Page"/> <input type="button" value="Next Page"/> <input type="button" value="Last Page"/> Page <input type="text"/> <input type="button" value="GO"/>								

4. At the bottom of the left hand panel, click **Save**.

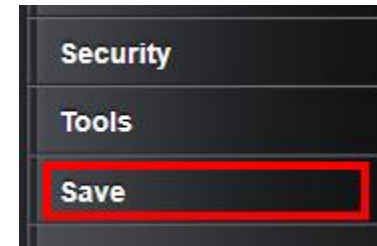

5. Select the Config you would like to save the settings to, click **Save Settings to Flash**, then click **OK**.

Note: This step saves all configuration changes to the NV-RAM to ensure that if the switch is rebooted or power cycled, the configuration changes will still be applied.

Save Settings to Flash		
Config File:	<input type="text" value="Config 1"/> ▼	<input checked="" type="checkbox"/> startup-config
Note: The switch will stop responding while saving the current configuration to flash.		
<input type="button" value="Save Settings to Flash"/>		

History

System > RMON > History

RMON histories are snapshots of port statistics. They are taken by the switch at predefined intervals and can be used to identify trends or patterns in the numbers or types of ingress packets on the ports on the switch. The snapshots can be viewed with your SNMP NMS software with the history group of the RMON portion of the MIB tree.

A history group is divided into buckets. Each bucket stores one snapshot of statistics of a port. A group can have from 1 to 50 buckets. The more buckets in a group, the more snapshots it can store.

1. Log into your switch management page (see "[Access your switch management page](#)" on page 5).
2. Click on **System**, click on **RMON**, and click on **History**.
3. Review the settings.
 - **Index:** This parameter specifies the ID number of the new group. The range is 1 to 65535.
 - **Port:** This parameter specifies the port where you want to monitor the statistical information of the Ethernet traffic.
 - **Buckets Requested:** This parameter defines the number of snapshots of the statistics for the port. Each bucket can store one snapshot of RMON statistics. Different ports can have different numbers of buckets. The range is 1 to 50 buckets.
 - **Interval:** This parameter specifies how frequently the switch takes snapshots of the port's statistics. The range is 1 to 3600 seconds (1 hour). For example, if you want the switch to take one snapshot every minute on a port, you specify an interval of sixty seconds.
 - **Owner:** This parameter is used to identify the person who created an entry. It is primarily intended for switches that are managed by more than one person, and is an optional field.

Click **Add** to add the entry to the table.

History Control Settings	
Index:	<input type="text"/> * (1-65535)
Port:	<input type="text"/> *
Buckets Requested:	<input type="text"/> (1-50)
Interval:	<input type="text"/> (1-3600 secs)
Owner:	<input type="text"/> (32 characters limit)

In the list, you can click **Modify** to modify an entry or click **Delete** or delete the entry. You can also click **Delete All** to delete all of the entries in the table. If the entries span multiple pages, you can navigate page number in the **Page** field and click **Go** or you can click **First**, **Previous**, **Next**, and **Last Page** to navigate the pages.

History Control Table							Delete All
Index	Port	Buckets Requested	Buckets Granted	Interval	Owner	Action	
<< Table is empty >>							
Page 0/0	First Page	Previous Page	Next Page	Last Page	Page <input type="text"/>	GO	

4. At the bottom of the left hand panel, click **Save**.
5. Select the Config you would like to save the settings to, click **Save Settings to Flash**, then click **OK**.

Note: This step saves all configuration changes to the NV-RAM to ensure that if the switch is rebooted or power cycled, the configuration changes will still be applied.

Alarms

System > RMON > Alarms

RMON alarms are used to generate alert messages when packet activity on designated ports rises above or falls below specified threshold values. The alert messages can take the form of messages that are entered in the event log on the switch or traps that are sent to your SNMP NMS software or both.

RMON alarms consist of two thresholds. There is a rising threshold and a falling threshold. The alarm is triggered if the value of the monitored RMON statistic of the designated port exceeds the rising threshold. The response of the switch is to enter a message in the event log, send an SNMP trap, or both. The alarm is reset if the value of the monitored statistic drops below the falling threshold.

The frequency with which the switch samples the thresholds of an alarm against the actual RMON statistic is controlled by a time interval parameter. You can adjust this interval for each alarm.

Here are the three components that comprise RMON alarms:

- **RMON statistics group:** A port must have an RMON statistics group configured if it is to have an alarm. When you create an alarm, you specify the port to which it is to be assigned not by the port number, but rather by the ID number of the port's statistics group.
- **RMON event:** An event specifies the action of the Switch when the ingress packet activity on a port crosses a statistical threshold defined in an alarm. The choices are to log a message in the event log of the Switch, send an SNMP trap to an SNMP workstation, or both. Since there are only three possible actions and since events can be used with more than one alarm, you probably will not create more than three events.
- **Alarm:** The last component is the alarm itself. It defines the port statistic to be monitored and the rising and falling thresholds that trigger the switch to perform an event. The thresholds of an alarm can have the same event or different events. The switch supports up to eight alarms.

1. Log into your switch management page (see "[Access your switch management page](#)" on page 5).
2. Click on **System**, click on **RMON**, and click on **Alarm**.
3. Review the settings.
 - **Index:** This parameter specifies the ID number of the new group. The range is 1 to 65535.
 - **Interval:** This parameter specifies the time (in seconds) over which the data is sampled. Its range is 1 to 2147483647 seconds.
 - **Variable:** This parameter specifies the RMON MIB object that the event is monitoring.
 - **Sample type:** This parameter defines the type of change that has to occur to trigger the alarm on the monitored statistic. There are two choices from the pull-down menu - Delta value and Absolute value. Delta value- setting compares a threshold against the difference between the current and previous values of the statistic. Absolute value- setting compares a threshold against the current value of the statistic.
 - **Rising Threshold:** This parameter specifies a specific value or threshold level of the monitored statistic. When the value of the monitored statistic becomes greater than this threshold level, an alarm event is triggered. The parameter's range is 1 to 2147483647.
 - **Falling Threshold:** This parameter specifies a specific value or threshold level of the monitored statistic. When the value of the monitored statistic becomes less than this threshold level, an alarm event is triggered. The parameter's range is 1 to 2147483647.
 - **Rising Event Index:** This parameter specifies the event index for the rising threshold. Its range is 1 to 65535. This field is mandatory and must match an Event Index that you previously entered in "Events".
 - **Falling Event Index:** This parameter specifies the event index for the falling threshold. Its range is 1 to 65535. This field is mandatory and must match an Event Index that you previously entered in "Events".
 - **Owner:** This parameter is used to identify the person who created an entry. It is primarily intended for switches that are managed by more than one person, and is an optional field.

Click **Add** to add the entry to the table.

RMON Alarm Settings	
Index:	<input type="text"/> * (1-65535)
Interval:	<input type="text"/> (1-2^31-1 secs)
Variable:	<input type="text"/> *
Sample type:	Absolute value ▾
Rising Threshold:	<input type="text"/> * (0-2^31-1)
Falling Threshold:	<input type="text"/> * (0-2^31-1)
Rising Event Index:	<input type="text"/> (1-65535)
Falling Event Index:	<input type="text"/> (1-65535)
Owner:	<input type="text"/> (32 characters limit)

In the list, you can click **Modify** to modify an entry or click **Delete** or delete the entry. You can also click **Delete All** to delete all of the entries in the table. If the entries span multiple pages, you can navigate page number in the **Page** field and click **Go** or you can click **First**, **Previous**, **Next**, and **Last Page** to navigate the pages.

RMON Alarm Table Delete All									
Free Entries : 256									
Total Entries : 0									
Index	Interval	Variable	Sample Type	Rising Threshold	Falling Threshold	Rising Event Index	Falling Event Index	Owner	Action
<< Table is empty >>									
<div style="display: flex; justify-content: space-between; align-items: center;"> Page 0/0 First Page Previous Page Next Page Last Page Page <input type="text"/> GO </div>									

5. At the bottom of the left hand panel, click **Save**.

6. Select the Config you would like to save the settings to, click **Save Settings to Flash**, then click **OK**.

Events

System > RMON > Event

An event specifies the action of the switch when the ingress packet activity on a port crosses a statistical threshold defined in an alarm. The choices are to log a message in the event log of the switch, send an SNMP trap to an SNMP workstation, or both. Since there are only three possible actions and since events can be used with more than one alarm, you probably will not create more than three events - one for each of the three actions.

1. Log into your switch management page (see "[Access your switch management page](#)" on page 5).
2. Click on **System**, click on **RMON**, and click on **Event**.
3. Review the settings.

- **Index:** This parameter specifies the ID number of the new group. The range is 1 to 65535.
- **Description:** This parameter specifies a text description of the event that you are configuring.
- **Type:** This parameter specifies where to log the event when it occurs. The choices are to log a message in the event log of the Switch, send an SNMP trap to the SNMP NMS software, or both.
- **Community:** This parameter specifies the community where you want to send the SNMP trap.
- **Owner:** This parameter is used to identify the person who created an entry. It is primarily intended for switches that are managed by more than one person, and is an optional field.

Click **Add** to add the entry to the table.

RMON Event Settings	
Index:	<input type="text"/> * (1-65535)
Description:	<input type="text"/> * (32 characters limit)
Type:	None ▾
Community:	<input type="text"/>
Owner:	<input type="text"/> (32 characters limit)

In the list, you can click **Modify** to modify an entry or click **Delete** or delete the entry. You can also click **Delete All** to delete all of the entries in the table. If the entries span multiple pages, you can navigate page number in the **Page** field and click **Go** or you can click **First**, **Previous**, **Next**, and **Last Page** to navigate the pages.

RMON Event Table Delete All						
Free Entries : 256						
Total Entries : 0						
Index	Description	Type	Community	Owner	Last Time Sent	Action
<< Table is empty >>						
Page 0/0 First Page Previous Page Next Page Last Page Page <input type="text"/> GO						

4. At the bottom of the left hand panel, click **Save**.

Security
Tools
Save

5. Select the Config you would like to save the settings to, click **Save Settings to Flash**, then click **OK**.

Note: This step saves all configuration changes to the NV-RAM to ensure that if the switch is rebooted or power cycled, the configuration changes will still be applied.

Save Settings to Flash		
Config File:	Config 1 ▾	<input checked="" type="checkbox"/> startup-config
Note: The switch will stop responding while saving the current configuration to flash.		
Save Settings to Flash		

Statistics

Statistics provide important information for troubleshooting switch problems at the port level. The Web Management Utility provides a two statistics charts, including Traffic Information and Error Information.

Traffic

System > Statistics > Traffic

1. Log into your switch management page (see "[Access your switch management page](#)" on page 5).
2. Click on **System**, click on **Statistics**, and click on **Traffic**.
3. View the Traffic Information Statistics.
 - **InOctets:** Inbound Octets (Bytes/s), number of inbound octet bits in bytes per second.
 - **InUcastPkts:** Inbound Unicast Packets (Pkts), number of inbound unicast packets in packets per second.
 - **InNUcastPkts:** Inbound Non-unicast Packets (Pkts), number of inbound non-unicast packets (such as broadcast and multicast packets) in packets per second.
 - **InDiscards:** Inbound Discards (Pkts), number of inbound discarded packets in packets per second.
 - **OutOctets:** Outbound Octets (Bytes/s), rate of outbound octet bits in bytes per second.
 - **OutUcastPkts:** Outbound Unicast Packets (Pkts), number of outbound unicast packets in packets per second.
 - **OutNUcastPkts:** Outbound Non-unicast Packets (Pkts), number of outbound non-unicast (such as broadcast and multicast packets) packets.
 - **OutDiscards:** Outbound Discards (Pkts), number of outbound discarded packets.
 - **Apply:** Click the **Apply** button to clear port specific Traffic information.
 - **Refresh:** Click the Refresh button to update table with newest traffic information.

Traffic Information									
Port ID	InOctets	InUcastPkts	InNUcastPkts	InDiscards	OutOctets	OutUcastPkts	OutNUcastPkts	OutDiscards	Clear
All	-	-	-	-	-	-	-	-	Apply
1	0	0	0	0	0	0	0	0	Apply
2	0	0	0	0	0	0	0	0	Apply
3	0	0	0	0	0	0	0	0	Apply
4	0	0	0	0	0	0	0	0	Apply
5	0	0	0	0	0	0	0	0	Apply
6	0	0	0	0	0	0	0	0	Apply
7	0	0	0	0	0	0	0	0	Apply
8	0	0	0	0	0	0	0	0	Apply
9	0	0	0	0	0	0	0	0	Apply
10	0	0	0	0	0	0	0	0	Apply
11	0	0	0	0	0	0	0	0	Apply

4. At the bottom of the left hand panel, click **Save**.

5. Select the Config you would like to save the settings to, click **Save Settings to Flash**, then click **OK**.

Note: This step saves all configuration changes to the NV-RAM to ensure that if the switch is rebooted or power cycled, the configuration changes will still be applied.

Save Settings to Flash

Config File: startup-config

Note: The switch will stop responding while saving the current configuration to flash.

[Save Settings to Flash](#)

Error

System > Statistic > Error

1. Log into your switch management page (see "[Access your switch management page](#)" on page 5).

2. Click on **System**, click on **Statistics**, and click on **Error**.

3. View the Error Information Statistics.

- **InErrors:** Inbound Errors (Pkts), number of inbound errors in packets per second.
- **OutErrors:** Outbound Errors (Pkts), number of outbound error packets.
- **DropEvents:** Drop Events, number of packets dropped.
- **CRCAlignErrors:** CRC and Align Errors, number of CRC and Align errors that have occurred.
- **UndersizePkts:** Undersize Packets (Pkts), number of undersized packets (less than 64 octets) received.
- **OversizePkts:** Oversize Packets (Pkts), number of oversized packets (over 2000 octets) received.
- **Fragments:** Number of fragments (packets with less than 64 octets, excluding framing bits, but including FCS octets) received.
- **Collisions:** Number of collisions received. If Jumbo Frames are enabled, the threshold of Jabber Frames is raised to the maximum size of Jumbo Frames.
- **Apply:** Click the Apply button to clear port specific Traffic information.
- **Refresh:** Click the Refresh button to update table with newest traffic information.

Error Information									
Port ID	InErrors	OutErrors	DropEvents	CRCAlignErrors	UndersizePkts	OversizePkts	Fragments	Collisions	Clear
All	-	-	-	-	-	-	-	-	Apply
1	0	0	0	0	0	0	0	0	Apply
2	0	0	0	0	0	0	0	0	Apply
3	0	0	0	0	0	0	0	0	Apply

4. At the bottom of the left hand panel, click **Save**.

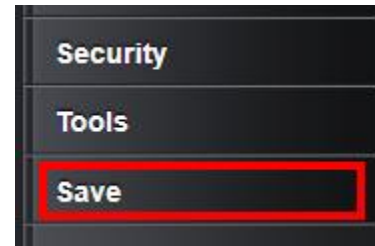

5. Select the Config you would like to save the settings to, click **Save Settings to Flash**, then click **OK**.

Note: This step saves all configuration changes to the NV-RAM to ensure that if the switch is rebooted or power cycled, the configuration changes will still be applied.

Save Settings to Flash

Config File: startup-config

Note: The switch will stop responding while saving the current configuration to flash.

Save Settings to Flash

IEEE 802.3az EEE

Enable IEEE 802.3az Power Saving Mode

System > IEEE 802.3az EEE

The IEEE 802.3 EEE standard defines mechanisms and protocols intended to reduce the energy consumption of network links during periods of low utilization, by transitioning interfaces into a low-power state without interrupting the network connection. The transmitted and received sides should be IEEE802.3az EEE compliance. By default, the switch disabled the IEEE 802.3az EEE function. Users can enable this feature via the IEEE802.3az EEE setting page.

1. Log into your switch management page (see "[Access your switch management page](#)" on page 5).
2. Click on **Tools** and click on **IEEE 802.3az EEE**.
3. Click the **IEEE 802.3az EEE Status** drop-down list and select **Enabled** to enable the power saving feature and click **Apply** to save the settings.

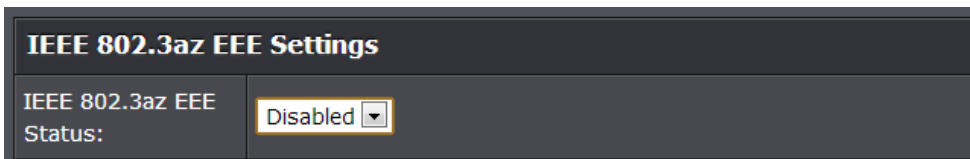

IEEE 802.3az EEE Settings	
IEEE 802.3az EEE Status:	Disabled ▾

4. At the bottom of the left hand panel, click **Save**.



Security
Tools
Save

5. Select the Config you would like to save the settings to, click **Save Settings to Flash**, then click **OK**.

Note: This step saves all configuration changes to the NV-RAM to ensure that if the switch is rebooted or power cycled, the configuration changes will still be applied.

Save Settings to Flash

Config File: Config 1 ▾ startup-config

Note: The switch will stop responding while saving the current configuration to flash.

Save Settings to Flash

Network

Physical Interface

Configure Physical Interfaces

Network > Physical Interface

This section allows you to configure the physical port parameters such as speed, duplex, flow control, and jumbo frames. This section also reports the current link status of each port and negotiated speed/duplex. Additionally you will be able to set your BPDU ports for Spanning Tree Configuration and EAP ports for 802.1x port-based authentication configuration.

1. Log into your switch management page (see "[Access your switch management page](#)" on page 5).
2. Click on **Network** and click on **Physical Interface**.
3. Review the settings. Click **Apply** to save changes.
 - **Port** - Specifies the port number. The All value indicates ports 1 through 10 on the Switch. You cannot change this parameter. You can use the **All** row value in the **Port** column to apply **Admin Status, Mode, Jumbo, Flow Contrl, EAP, BPDU** settings to all ports at the same time.
 - **Trunk** - This parameter indicates the trunk group number. A number in this column indicates that the port has been added to a trunk using static or dynamic 802.3ad LACP link aggregation.
 - **Type** - This parameter indicates the port type. On the Switch, the port type is 100TX for 10/100/1000Base-T twisted-pair ports (1-8) and 100FX or 100TX for the SFP ports (9-10) for fiber SFP type.
 - **Link Status** - This parameter indicates the status of the link between the port and the end node connected to the port. The possible values are:

- **Up** -This parameter indicates a valid link exists between the port and the end node.
- **Down** -This parameter indicates the port and the end node have not established a valid link.
- **Admin. Status:** This parameter indicates the operating status of the port. You can use this parameter to enable or disable a port. You may want to disable a port and prevent packets from being forwarded if a problem occurs with the node or cable connected to the port. You can enable the port to resume normal operation after the problem has been fixed. You can also disable an unused port to secure it from unauthorized connections. The possible values are:
 - **Ignore** -This parameter applies to the **All** row only and indicates that the **Admin. Status** field must be set individually for each port.
 - **Enabled** - This parameter indicates the port is able to send and receive Ethernet frames.
 - **Disabled** - This parameter indicates the port is not able to send and receive Ethernet frames.
- **Mode:** This parameter indicates the speed and duplex mode settings for the port. You can use this parameter to set the speed and duplex mode of a port. The possible settings are:
 - **Ignore** -This parameter indicates that the **All** setting does not apply to the **Mode** field. In other words, each port is set individually.
 - **Auto** -This parameter indicates the port is using Auto-Negotiation to set the operating speed and duplex mode. The actual operating speed and duplex mode of the port are displayed in parentheses (for example, "1000/F" for 1000 Mbps full duplex mode) after a port establishes a link with an end node.
 - **Auto (1000F)** -This parameter indicates the port is configured for 1000Mbps operation in Auto-Negotiation mode.
 - **1000/Full** -This parameter indicates the port is configured for 1000Mbps operation in full-duplex mode.
 - **100/Full** -This parameter indicates the port is configured for 100Mbps operation in full-duplex mode.
 - **10/Full** -This parameter indicates the port is configured for 10Mbps operation in full-duplex mode.

- **100/Half** -This parameter indicates the port is configured for 100Mbps operation in half-duplex mode.
- **10/Half** -This parameter indicates the port is configured for 10Mbps operation in half-duplex mode.

Note: When selecting a **Mode** setting, the following points apply:

- When a twisted-pair port is set to Auto-Negotiation, the end node should also be set to Auto-Negotiation to prevent a duplex mode mismatch.
- A switch port using Auto-Negotiation defaults to half-duplex if it detects that the end node is not using Auto-Negotiation. This can result in a mismatch if the end node is operating at a fixed duplex mode of full-duplex. To avoid this problem when connecting an end node with a fixed duplex mode of full-duplex to a switch port, disable Auto-Negotiation on the port and set the port's speed and duplex mode manually.
- The only valid setting for the SFP ports is Auto-Negotiation.
- **Jumbo:** This parameter indicates whether or not jumbo frames can be accepted by the switch. You may want to activate jumbo frames when your switch will transmit video and audio files. The possible values are:
 - **Ignore** -This parameter indicates that the **All** setting does not apply to the **Jumbo** field. In other words, each port is set individually.
 - **Enabled** -This parameter indicates the port is permitted to accept jumbo frames.
 - **Disabled** -This parameter indicates the port is not permitted to accept jumbo frames.

Note: When **QoS** is enabled on a port, the **Jumbo frame** parameter cannot be enabled.

- **Flow Ctrl:** Flow Control, This parameter reflects the current flow control setting on the port. The switch uses a special pause packet to notify the end node to stop transmitting for a specified period of time. The possible values are:
 - **Ignore** - This parameter indicates that the **All** setting does not apply to the **Flow Control** field. In other words, each port is set individually.
 - **Enabled** - This parameter indicates that the port is permitted to use flow control.

- **Disabled** - This parameter indicates that the port is not permitted to use flow control.
- **EAP:** This parameter reflects the current Extensible Authentication Protocol (EAP) setting on the port. The possible values are:
 - **Ignore** - This parameter indicates that the **All** setting does not apply to the **EAP** field. In other words, each port is set individually.
 - **Enabled** - This parameter indicates that the port is able to send and receive EAP packets.
 - **Disabled** - This parameter indicates that the port is disabled and is not able to send or receive EAP packets.
- **BPDU:** This parameter reflects the current BPDU setting on the port. The possible values are:
 - **Ignore** - This parameter indicates that the **All** setting does not apply to the **BPDU** field. In other words, each port is set individually.
 - **Enabled** - This parameter indicates that the switch will pass BPDU frames through the switch and broadcast them through all other ports.
 - **Disabled** - This parameter indicates that the switch will not pass BPDU frames through the switch, With RSTP or STP enabled, the switch will receive BPDU frames and process them according to the spanning tree protocol.

Type	Link Status	Admin. Status	Mode	Jumbo	Flow Ctrl	EAP PassThrough	BPDU PassThrough	Port Description	Action
-	-	Ignore	Ignore	Ignore	Ignore	Ignore	Ignore		Apply
1000TX	Up	Enabled	Auto (100)	Enabled	Disabled	Disabled	Enabled		Apply
1000TX	Down	Enabled	Auto	Enabled	Disabled	Disabled	Enabled		Apply
1000TX	Down	Enabled	Auto	Enabled	Disabled	Disabled	Enabled		Apply
1000TX	Down	Enabled	Auto	Enabled	Disabled	Disabled	Enabled		Apply

4. At the bottom of the left hand panel, click **Save**.

5. Select the Config you would like to save the settings to, click **Save Settings to Flash**, then click **OK**.

Note: This step saves all configuration changes to the NV-RAM to ensure that if the switch is rebooted or power cycled, the configuration changes will still be applied.

Spanning Tree

Protocol

Network > Spanning Tree > Protocol

Spanning Tree Protocol (STP) provides network topology for any arrangement of bridges/switches. STP also provides a single path between end stations on a network, eliminating loops. Loops occur when alternate routes exist between hosts. Loops in an extended network can cause bridges to forward traffic indefinitely, resulting in increased traffic and reducing network efficiency.

1. Log into your switch management page (see "[Access your switch management page](#)" on page 5).
2. Click on **Network**, click on **Spanning Tree**, and click on **Protocol**.
3. Review the settings. Click **Apply** to save changes.
 - **Global STP Status:** Select the STP state on the device. The possible field values are:
 - **Disable** – Disables STP on the device. This is the default value.
 - **Enable** – Enables STP on the device.
 - **Protocol Version:** Specifies the Spanning Tree Protocol (STP) mode to enable on the switch. The possible field values are:
 - **STP** – Enables STP 802.1d on the device.
 - **RSTP** – Enables Rapid STP 802.1w on the device. This is the default value.
 - **MSTP** – Enables Multiple STP 802.1s on the device.
 - **Bridge Priority:** The **Bridge Priority** has a range 0 to 61440 in increments of 4096. To make this easier for you, the Web Management Utility divides the range into increments. You specify the increment that represents the desired bridge priority value.
 - **Maximum Age:** The Maximum Age defines the amount of time a port will wait for STP/RSTP information. MSTP uses this parameter when interacting with STP/RSTP domains on the boundary ports. Its range is 6 - 40 seconds

- **Hello Time:** The Hello Time is frequency with which the root bridge sends out a BPDU.
- **Forward Delay:** The Forward Delay defines the time that the bridge spends in the listening and learning states. Its range is 4 - 30 seconds.
- **Transmit Hold Count:** The Transmit Hold Count specifies the maximum number of BPDUs that the bridge can send per second. Its range is 1 - 10.
- **Max Hop Count:** The Max Hop Count is a parameter set in a BPDU packet when it originates. It is decremented by 1 each time it is retransmitted by the next bridge. When the Hop Count value reaches zero, the bridge drops the BPDU packet. Its range is 6 - 40 hops.

Spanning Tree Protocol Settings	
Global STP Status:	Enabled ▾
Protocol Version:	RSTP ▾
Bridge Priority:	32768 ▾
Maximum Age:	20 Sec. (6-40)
Hello Time:	2 Sec. (1-10)
Forward Delay:	15 Sec. (4-30)
Transmit Hold Count:	6 (1-10)
Max Hop Count:	20 (6-40)

Note : Enabling Spanning Tree will cause the system to temporarily stop responding

In addition, this section also displays the spanning tree root information.

Root Information	
Root Bridge:	00:00:00:00:00:00:00
Root Cost:	0
Root Maximum Age:	20
Root Forward Delay:	15
Root Port:	0

Port

Network > Spanning Tree > Port

1. Log into your switch management page (see "[Access your switch management page](#)" on page 5).
2. Click on **Network**, click on **Spanning Tree**, and click on **Port**.
3. Review the settings. For each entry, click **Apply** to save changes.

- **STP Status:** Indicates if spanning tree protocol is active or not on the port. Select one of the following choices from the pull-down menu:
 - **Enable** - The spanning tree protocol is enabled on the port.
 - **Disabled** - The spanning tree protocol is disabled on the port.

Note: BPDU passthrough must be disabled for all ports under Physical interface for STP can be enabled.

- **Priority:** Indicates the port priority. If two paths have the same port cost, the bridges must select a preferred path. In some instances this can involve the use of the port priority parameter which is used as a tie breaker when two paths have the same cost.

The range for port priority is 0 to 240. As with bridge priority, this range is broken into increments, in this case multiples of 16. To select a port priority for a port, you enter the desired value. Table 1 lists the values that are valid.

Valid Port Priority Values

Step	1	2	3	4	5	6	7	8	9	10	11	12	13	14	15	16
Port Priority	0	16	32	48	64	80	96	112	128	144	160	176	192	208	224	240

- **Admin Cost (0 = Auto):** The administratively assigned value for the contribution of this port to the path cost of paths towards the spanning tree root. Writing a value of '0' assigns the automatically calculated default Path Cost value to the port. If the default Path Cost is being used, this object returns '0' when read.

- **External Cost:** This defines a metric that indicates the relative cost of forwarding packets to the specified port list. Port cost can be set automatically or as a metric value. Define a value between **1** and **200000000** to determine the external cost. The lower the number, the greater the probability the port will be chosen to forward packets. The default port cost: 100Mbps port = 200000. Gigabit port = 20000.
- **Status** – Displays the current port spanning tree status.
 - **Blocking** - A blocking state does not allow network traffic to be sent or received on a the port except for BPDU data. A port with a higher path cost to the root bridge than another on the switch causes a switching loop and is placed in the blocking state by the Spanning Tree algorithm. The port's state may change to the forwarding state if the other links in use fail and the Spanning Tree algorithm determines the port may transition to the forwarding state.
 - **Listening** - This state occurs on a port during the convergence process. The port in the listening state processes BPDUs and awaits new information that would cause the port to return to the blocking state.
 - **Learning** - While the port does not yet forward frames (packets), in this state the port does learn source addresses from frames received and adds them to the filtering (switching) database.
 - **Forwarding** - A port that both receives and sends data. This indicates normal operation. STP continues to monitor the port for incoming BPDUs that indicate the port should return to the blocking state to prevent a loop.
 - **Disabled** - This state is not strictly part of STP. However, a network administrator can manually disable a port.
- **Edge:** Indicates if a port is connected to an edge device in the network topology or not. Selecting the **Forcetrue** parameter designates the port as an edge port. Edge ports cannot create loops, however an edge port can lose edge port status if a topology change creates a potential for a loop. An edge port normally should not receive BPDU packets. If a BPDU packet is received, it automatically loses edge port status. Selecting the **Forcefalse** parameter indicates that the port does not have edge port status. Selecting the **Auto** parameter indicates that the port have edge port status or not have edge port status automatically. The default setting for this parameter is **Auto**.

- **P2P:** Choosing the **Forcetrue** parameter indicates a point-to-point (P2P) shared link. P2P ports are similar to edge ports however they are restricted in that a P2P port must operate in full-duplex.

Like edge ports, P2P ports transition to a forwarding state rapidly thus benefiting from RSTP. A P2P value of **Forcefalse** indicates that the port cannot have P2P status. **Auto** allows the port to have P2P status whenever possible and operate as if the P2P status were true. If the port cannot maintain this status, (for example if the port is forced to half-duplex operation) the P2P status changes to operate as if the P2P value were **Forcefalse**.

The default setting for this parameter is **Auto**.

- **Restricted Role:** Toggle between **True** and **False** to set the restricted role state of the packet. If set to **True**, the port will never be selected to be the Root port. The default value is **False**.
- **Restricted TCN:** Toggle between **True** and **False** to set the restricted TCN of the packet. Topology Change Notification (TCN) is a BPDU that a bridge sends out to its root port to signal a topology change. If set to **True**, it stops the port from propagating received TCN and to other ports. The default value is **False**.
- **Migrate:** Indicates if the port is configured to accept RSTP and STP BPDUs.

Port Settings											
Port	STP Status	Priority	Admin Cost (0 = Auto)	External Cost	Status	Edge	P2P	Restricted Role	Restricted TCN	Migrate	Apply
All	Ignore	Ignore		-	-	Ignore	Ignore	Ignore	Ignore	Restart	Apply
1	Enabled	128	0	20000	Disabled	Auto	Auto	False	False	Restart	Apply
2	Enabled	128	0	20000	Disabled	Auto	Auto	False	False	Restart	Apply
3	Enabled	128	0	20000	Disabled	Auto	Auto	False	False	Restart	Apply

- At the bottom of the left hand panel, click **Save**.
- Select the Config you would like to save the settings to, click **Save Settings to Flash**, then click **OK**.

Note: This step saves all configuration changes to the NV-RAM to ensure that if the switch is rebooted or power cycled, the configuration changes will still be applied.

MST

Network > Spanning Tree > MST

- Log into your switch management page (see "[Access your switch management page](#)" on page 5).
- Click on **System**, click on **Spanning Tree**, and click on **MST**.
- Review the settings. For each section, click **Apply** to save changes.

MST Configuration Identification Settings

- **Configuration Name:** A configured name set on the switch to uniquely identify the MSTI (Multiple Spanning Tree Instance). If a configuration name is not set, this field shows the MAC address of the device running MSTP.
- **Revision Level (0-65535):** This value, together with the configuration name, and identical vlans mapped for STP instance IDs identifies the MST region configured on the switch.

MST Configuration Identification Settings	
Configuration Name:	<input type="text" value="000102030405"/>
Revision Level:	<input type="text" value="0"/> (0-65535)

MST Instance Settings

- **MSTI ID (1 - 31):** Displays the MSTI ID associated with the VID List. The possible field range is 1-31.
- **VID List (1 - 4094):** Displays the VID List. Click **Add** to add into MST Table below.
- **Priority:** Enter the new priority in the Priority field. The user may set a priority value between **0-61440**.

MST Instance Settings

MSTI ID:	<input type="text"/> * (1-31)
VID List:	<input type="text"/> (1-4094)
Priority:	<input type="text" value="0"/> ▾

- **MST Table:** Make changes to the table entry, and click **Apply** modify or click **Delete** to remove the ID entry.

MST Table

MSTI ID	VID List	Priority	Action
CIST	<input type="text" value="1-4094"/>	<input type="text" value="32768"/> ▾	<input type="button" value="Apply"/> <input type="button" value="Delete"/>

4. At the bottom of the left hand panel, click **Save**.

The screenshot shows a vertical navigation menu with three items: 'Security', 'Tools', and 'Save'. The 'Save' button is highlighted with a red rectangular border.

5. Select the Config you would like to save the settings to, click **Save Settings to Flash**, then click **OK**.

Note: This step saves all configuration changes to the NV-RAM to ensure that if the switch is rebooted or power cycled, the configuration changes will still be applied.

Save Settings to Flash

Config File:	<input type="text" value="Config 1"/> ▾	<input checked="" type="checkbox"/> startup-config
--------------	---	--

Note: The switch will stop responding while saving the current configuration to flash.

Instance

Network > Spanning Tree > Instance

1. Log into your switch management page (see "[Access your switch management page](#)" on page 5).
2. Click on **System**, click on **Spanning Tree**, and click on **Instance**.
3. View your MSTP instance information.

- **MSTI ID** – Specifies the instance to which the VLAN is assigned.
- **Internal Root Cost** – Indicates cost of forwarding packets to specified ports when an interface is selected within a STP instance.
- **Root Port** – Indicates the selected instance's root port.
- **Regional Root Bridge** – Displays the ID of the Regional Internal Root Bridge.
- **Designated Bridge** – Displays the ID of the bridge that connects the link or shared LAN to the root.
- **Instance Priority** – Specifies the selected spanning tree instance device priority. The field range is 0-61440. The field default is 32768.

Instance Information

MSTI ID	Internal Root Cost	Root Port	Regional Root Bridge	Designated Bridge	Instance Priority
CIST	0	0	80:00:00:01:02:03:04:05	80:00:00:01:02:03:04:05	32768

MST Port

Network > Spanning Tree > MST Port

1. Log into your switch management page (see "[Access your switch management page](#)" on page 5).
2. Click on **Network**, click on **Spanning Tree**, and click on **MST Port**.
3. Review the settings. For each entry, click **Apply** to save changes.
 - **Select MST Port** – Click the drop-down to select which MST port to configure.

MST Port Settings

Select MST Port

01

- **MST Port Info** - The MST Port Information page provides user to configure the MSTP Interface settings.
 - **Admin Path Cost (0 = Auto)** - This is the port cost used by MSTP when calculating path cost to the root bridge.
 - **Priority** - This is the port priority used by MSTP in calculating path costs when two ports on the switch have the same port cost.

MST Port Info

MSTI ID	Designated Bridge	Internal Path Cost	Admin Path Cost (0 = Auto)	Priority	Status	Role	Action
CIST	80:00:00:01:02:03:04:05	20000	0	128	Disabled	Disabled	Apply

4. At the bottom of the left hand panel, click **Save**.
5. Select the Config you would like to save the settings to, click **Save Settings to Flash**, then click **OK**.

Note: This step saves all configuration changes to the NV-RAM to ensure that if the switch is rebooted or power cycled, the configuration changes will still be applied.

Trunk

The trunking function enables the cascading of two or more ports for a combined larger total bandwidth. Up to 8 trunk groups may be created, each supporting up to 8 ports. Add a trunking Name and select the ports to be trunked together, and click Apply to activate the selected trunking groups.

Important Note: Do not connect the cables of a port trunk to the ports on the switch until you have configured the ports on both the switch and the end nodes. Connecting the cables prior to configuring the ports can create loops in your network topology. Loops can result in broadcast storms which can severely limited the effective bandwidth of your network.

Settings

Network > Trunk > Settings

1. Log into your switch management page (see "[Access your switch management page](#)" on page 5).
2. Click on **Network**, click on **Trunk**, and click on **Settings**.
3. Review the settings. For each trunk group, click **Apply** to save changes.

For each Trunk ID/Group, check the port numbers to add for each trunk group.

Trunking Settings																			
Trunk ID 1:	1	2	3	4	5	6	7	8	9	10	11	12	13	14	15	16	17	18	Disabled ▾ Apply
	<input type="checkbox"/>	<input type="checkbox"/>	<input type="checkbox"/>	<input type="checkbox"/>	<input type="checkbox"/>	<input type="checkbox"/>	<input type="checkbox"/>	<input type="checkbox"/>	<input type="checkbox"/>	<input type="checkbox"/>	<input type="checkbox"/>	<input type="checkbox"/>	<input type="checkbox"/>	<input type="checkbox"/>	<input type="checkbox"/>	<input type="checkbox"/>	<input type="checkbox"/>	<input type="checkbox"/>	
	19	20																	
	<input type="checkbox"/>	<input type="checkbox"/>																	
Trunk ID 2:	1	2	3	4	5	6	7	8	9	10	11	12	13	14	15	16	17	18	Disabled ▾ Apply
	<input type="checkbox"/>	<input type="checkbox"/>	<input type="checkbox"/>	<input type="checkbox"/>	<input type="checkbox"/>	<input type="checkbox"/>	<input type="checkbox"/>	<input type="checkbox"/>	<input type="checkbox"/>	<input type="checkbox"/>	<input type="checkbox"/>	<input type="checkbox"/>	<input type="checkbox"/>	<input type="checkbox"/>	<input type="checkbox"/>	<input type="checkbox"/>	<input type="checkbox"/>	<input type="checkbox"/>	
		<input type="checkbox"/>	<input type="checkbox"/>																

Click the drop-down list and select one of the following options.

- **Active** - The specific aggregator will broadcast and respond to LACPDU (LACP Data Unit) packets. This setting enables the dynamic LACP feature for the trunk.
- **Passive** - The specific aggregator will not broadcast LACPDU packets, but it will respond to them. This setting disables the LACP feature for the trunk
- **Manual** - Enables static port trunking and disables the LACP feature for the trunk. (Static link aggregation).
- **Disable** - Disables the static port trunk and disables the LACP feature.

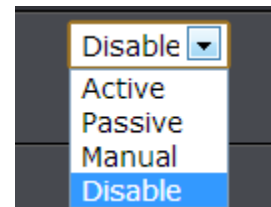

4. At the bottom of the left hand panel, click **Save**.
5. Select the Config you would like to save the settings to, click **Save Settings to Flash**, then click **OK**.

Note: This step saves all configuration changes to the NV-RAM to ensure that if the switch is rebooted or power cycled, the configuration changes will still be applied.

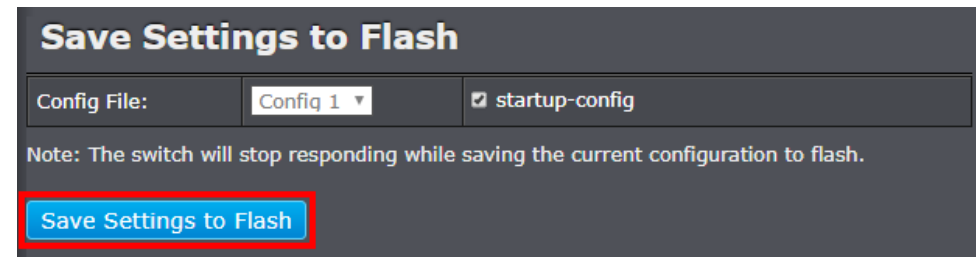

Status

Network > Trunk > Status

1. Log into your switch management page (see "[Access your switch management page](#)" on page 5).
2. Click on **Network**, click on **Trunk**, and click on **Status**.
3. View your trunk group status information.
 - **System Priority** - Preassigned setting that cannot be modified. This value applies to the switch.
 - **System ID** - MAC address value assigned to the individual switch. This value cannot be modified.
 - **Group: #** The ID number of the trunk (link aggregation group).

LACP Group Status	
System Priority:	32768
System ID:	00:01:02:03:04:05
Group: 1	This group doesn't exist
Group: 2	This group doesn't exist

Port Priority

Network > Trunk > Port Priority

1. Log into your switch management page (see "[Access your switch management page](#)" on page 5).
2. Click on **Network**, click on **Trunk**, and click on **Port Priority**.
3. Review the settings. Click **Apply** to save changes.

To assign a port higher priority within a trunk group, find the port number and in the priority column, enter a priority value 0-65535 (65535 being the highest priority).

Port Priority Settings	
Port	Priority (0-65535)
1	<input type="text" value="0"/>
2	<input type="text" value="0"/>
3	<input type="text" value="0"/>

4. At the bottom of the left hand panel, click **Save**.
5. Select the Config you would like to save the settings to, click **Save Settings to Flash**, then click **OK**.

Note: This step saves all configuration changes to the NV-RAM to ensure that if the switch is rebooted or power cycled, the configuration changes will still be applied.

Save Settings to Flash		
Config File:	<input type="text" value="Config 1"/>	<input checked="" type="checkbox"/> startup-config
Note: The switch will stop responding while saving the current configuration to flash.		
Save Settings to Flash		

Mirroring

Configure port mirror settings

Network > Mirroring

Port mirroring allows you to monitor the ingress and egress traffic on a port by having the traffic copied to another port where a computer or device can be set up to capture the data for monitoring and troubleshooting purposes.

1. Log into your switch management page (see "[Access your switch management page](#)" on page 5).
2. Click on **Network**, and click on **Mirroring**.
3. Review the settings. Click **Apply** to save changes.
 - **Status** – Click the drop-down and list and select one of the following options:
 - **Enable** - This parameter activates the Port Mirroring feature and the rest of the configuration parameters become active on the page.
 - **Disable** - This parameter de-activates the Port Mirroring feature and the rest of the configuration parameters become inactive on the page.
 - **Mirror Target Port** – Click the drop-down and list and select the port to send the copied ingress/egress packets/data. (e.g. Computer or device with packet capture or data analysis program.)

Mirroring Settings	
Status:	Enabled ▾
Mirror Target Port:	1 ▾

Check the port to monitor or copy information from. (Source)

To copy data received on a specific port, check the port number(s) under the **Ingress Port** section or you could click **All** to copy data received on all ports.

To copy data transmitted on specific port, check the port number under the **Egress Port** section or you could click **All** to copy data transmitted on all ports.

Mirroring Port Settings										
Ingress Port :										
	1	2	3	4	5	6	7	8	9	10
All	<input type="checkbox"/>	<input type="checkbox"/>	<input type="checkbox"/>	<input type="checkbox"/>	<input type="checkbox"/>	<input type="checkbox"/>	<input type="checkbox"/>	<input type="checkbox"/>	<input type="checkbox"/>	<input type="checkbox"/>
	11	12	13	14	15	16	17	18	19	20
	<input type="checkbox"/>	<input type="checkbox"/>	<input type="checkbox"/>	<input type="checkbox"/>	<input type="checkbox"/>	<input type="checkbox"/>	<input type="checkbox"/>	<input type="checkbox"/>	<input type="checkbox"/>	<input type="checkbox"/>
Egress Port :										
	1	2	3	4	5	6	7	8	9	10
All	<input type="checkbox"/>	<input type="checkbox"/>	<input type="checkbox"/>	<input type="checkbox"/>	<input type="checkbox"/>	<input type="checkbox"/>	<input type="checkbox"/>	<input type="checkbox"/>	<input type="checkbox"/>	<input type="checkbox"/>
	11	12	13	14	15	16	17	18	19	20
	<input type="checkbox"/>	<input type="checkbox"/>	<input type="checkbox"/>	<input type="checkbox"/>	<input type="checkbox"/>	<input type="checkbox"/>	<input type="checkbox"/>	<input type="checkbox"/>	<input type="checkbox"/>	<input type="checkbox"/>
Apply										

4. At the bottom of the left hand panel, click **Save**.

5. Select the Config you would like to save the settings to, click **Save Settings to Flash**, then click **OK**.

Note: This step saves all configuration changes to the NV-RAM to ensure that if the switch is rebooted or power cycled, the configuration changes will still be applied.

Save Settings to Flash		
Config File:	Config 1 ▾	<input checked="" type="checkbox"/> startup-config
Note: The switch will stop responding while saving the current configuration to flash.		
Save Settings to Flash		

Loopback Detection

Enable loopback detection

Network > Loopback Detection

The loopback detection feature allows the switch to detect and prevent disruption from loops that occur on uplink or downlink switches directly connected to your switch.

1. Log into your switch management page (see "[Access your switch management page](#)" on page 5).
2. Click on **Network** and click on **Loopback Detection**.
3. Review the settings.
 - **Loopback Detection Status** – Select **Enabled** to enable the loopback detection feature. Select **Disabled** to disabled the loopback detection feature.
 - **Interval** – Defines the interval your switch will check for loops.
 - **Recover Time** – Defines the time period when connectivity will be restored to a port where a loop was previously detected and blocked.

Click **Apply** to save changes.

Loopback Detection Settings	
Loopback Detection Status:	Enabled ▾
Loopback Detection Time Settings	
Interval:	2 sec(1-32767)
Recover Time:	60 sec(0 or 60-1000000, 0 is Disabled)

In the Loopback Detection table, select one of the **Loopback Detection Status** choices from the pull down menu:

Ignore: This parameter indicates that the setting in the **All** row do not apply to the **Loopback Detection Status** field. In other words, each port is set individually.

- **Enabled:** This selection enables the Loopback Detection feature for each port. This state must be enabled along with the **Status** field at the top of the page before this feature can be active on the selected port.
- **Disabled:** This selection disables the Loopback Detection feature on the selected port.
- **Note:** In the **All** row when you select **Enable** or **Disable** instead of **Ignore**, the selection applies to all of the Switch ports.

Next to each entry modified, under the **Action** column, click **Apply** to save the changes.

Loopback Detection Table			
Port	Loopback Detection Status	Loop Status	Action
All	Ignore ▾	-	Apply
1	Disabled ▾	Normal	Apply
2	Disabled ▾	Normal	Apply
3	Disabled ▾	Normal	Apply

4. At the bottom of the left hand panel, click **Save**.

5. Select the Config you would like to save the settings to, click **Save Settings to Flash**, then click **OK**.

Note: This step saves all configuration changes to the NV-RAM to ensure that if the switch is rebooted or power cycled, the configuration changes will still be applied.

Static Unicast

Add static unicast entries to the switch

Network > Static Unicast

In this section, you can add static unicast entries to the switch configuration.

1. Log into your switch management page (see "[Access your switch management page](#)" on page 5).
2. Click on **Network** and click on **Static Unicast**.
3. Review the settings.
 - **802.1Q VLAN** – Enter the VLAN ID where the MAC address will reside.
Note: By default, all switch ports are part of the default VLAN, VLAN ID 1.
 - **MAC Address** – Enter the MAC address of the device to add.
 - **Port Member** – Select the port where the MAC address will reside.

Click **Apply** to add the Static Unicast entry to the list.

Static Unicast Address Settings

802.1Q VLAN: (1-4094)

MAC Address: : : : : :

Port Member Settings

1	2	3	4	5	6	7	8	9	10
●	●	●	●	●	●	●	●	●	●
11	12	13	14	15	16	17	18	19	20
●	●	●	●	●	●	●	●	●	●

In the list, you can click **Modify** to modify an entry or click **Delete** or delete the entry. You can also click **Delete All** to delete all the entries in the list. If the entries span multiple pages, you can navigate page number in the **Page** field and click **Go** or you can click **First**, **Previous**, **Next**, and **Last Page** to navigate the pages.

Static Unicast Table (Free entries:256, Total entries:0)

VLAN	MAC Address	Port Member	Action
<< 802.1Q VLAN Static Unicast Address Table is empty >>			

Page 0/0 Page

4. At the bottom of the left hand panel, click **Save**.

5. Select the Config you would like to save the settings to, click **Save Settings to Flash**, then click **OK**.

Note: This step saves all configuration changes to the NV-RAM to ensure that if the switch is rebooted or power cycled, the configuration changes will still be applied.

Save Settings to Flash

Config File: startup-config

Note: The switch will stop responding while saving the current configuration to flash.

Static Multicast

Add static multicast entries to the switch

Network > Static Multicast

In this section, you can add static multicast entries to the switch configuration.

1. Log into your switch management page (see "[Access your switch management page](#)" on page 5).
2. Click on **Network** and click on **Static Multicast**.
3. Review the settings.
 - **802.1Q VLAN** – Enter the VLAN ID where the multicast group MAC address will reside.
Note: By default, all switch ports are part of the default VLAN, VLAN ID 1.
 - **MAC Address** – Enter the multicast group MAC address.
 - **Group Member** – Check the port(s) where the MAC address will reside.
*Note: You can click **All** to select all ports.*

Click **Apply** to add the Static Multicast Group entry to the list.

Static Multicast Address Settings

802.1Q VLAN:	<input type="text" value=""/> (1-4094)
Group MAC Address:	<input type="text" value=""/> : <input type="text" value=""/> : <input type="text" value=""/> : <input type="text" value=""/> : <input type="text" value=""/> : <input type="text" value=""/>

Group Member

	1	2	3	4	5	6	7	8	9	10
<input type="button" value="All"/>	<input type="checkbox"/>	<input type="checkbox"/>	<input type="checkbox"/>	<input type="checkbox"/>	<input type="checkbox"/>	<input type="checkbox"/>	<input type="checkbox"/>	<input type="checkbox"/>	<input type="checkbox"/>	<input type="checkbox"/>
	11	12	13	14	15	16	17	18	19	20
	<input type="checkbox"/>	<input type="checkbox"/>	<input type="checkbox"/>	<input type="checkbox"/>	<input type="checkbox"/>	<input type="checkbox"/>	<input type="checkbox"/>	<input type="checkbox"/>	<input type="checkbox"/>	<input type="checkbox"/>

In the list, you can click **Modify** to modify an entry or click **Delete** or delete the entry. If the entries span multiple pages, you can navigate page number in the **Page** field and click **Go** or you can click **First**, **Previous**, **Next**, and **Last Page** to navigate the pages.

Static Multicast Table (Free entries:256, Total entries:0) <input type="button" value="Delete All"/>			
VLAN ID	MAC Address	Group Members	Action
<< Static multicast address table is empty >>			
Page 0/0 <input type="button" value="First Page"/> <input type="button" value="Previous Page"/> <input type="button" value="Next Page"/> <input type="button" value="Last Page"/> Page <input style="width: 20px;" type="text"/> <input type="button" value="GO"/>			

4. At the bottom of the left hand panel, click **Save**.
5. Select the Config you would like to save the settings to, click **Save Settings to Flash**, then click **OK**.

Note: This step saves all configuration changes to the NV-RAM to ensure that if the switch is rebooted or power cycled, the configuration changes will still be applied.

Save Settings to Flash

Config File: startup-config

Note: The switch will stop responding while saving the current configuration to flash.

IGMP Snooping

Settings

Network > IGMP Snooping > Settings

1. Log into your switch management page (see "[Access your switch management page](#)" on page 5).
2. Click on **Network**, click on **IGMP Snooping**, and click on **Settings**.
3. Review the settings. Click **Apply** to save the settings.
 - **Status** – Click the drop-down list and select **Enabled** to enable the IGMP snooping feature or **Disabled** to disable the feature.
 - **Age-Out Timer** – Enter the amount of time in seconds that you want your switch to wait before it purges an inactive dynamic MAC address.
 - **Querier Status** – Click the drop-down list and select **Enabled** to enable the Querier Status or **Disabled** to disable this feature.
 - **Querier Interval** – Enter the amount of time you want your switch to send IGMP queries.
 - **Max Response Time**- Specifies the maximum time before sending a response report.
 - **Robustness Variable**- Enter a variable for the expected packet loss on a subnet. The robustness variable should be set to a larger value if higher packet loss is expected.
 - **Last Member Query Interval** - Set the response time for group queries sent in response to leave messages.
 - **Router Timeout** - Enter the maximum time duration without router messages before the router timeout.

IGMP Snooping Settings	
Status:	Disabled ▾
Age-Out Timer:	260 Sec. (130-153025)
Querier Status:	Disabled ▾
Query Interval:	125 Sec. (60-600)
Max Response Time:	10 Sec. (10-25)
Robustness Variable:	2 Sec. (2-255)
Last Member Query Interval:	1 Sec. (1-25)
Router Timeout:	250 Sec. (120-1200)

The table below displays the static multicast address groups defined in your switch for reference and can be modified on under *Bridge > Static Multicast* or dynamically updated with the active multicast address groups.

Multicast Group Entries (Free entries:256, Total entries:0)		
VLAN ID	Multicast Group Address	Member Ports
<< IGMP Snooping multicast address table is empty >>		
Page 0/0 First Page Previous Page Next Page Last Page Page <input type="text"/> GO		

4. At the bottom of the left hand panel, click **Save**.
5. Select the Config you would like to save the settings to, click **Save Settings to Flash**, then click **OK**.

Note: This step saves all configuration changes to the NV-RAM to ensure that if the switch is rebooted or power cycled, the configuration changes will still be applied.

Save Settings to Flash

Config File:	Config 1 ▾	<input checked="" type="checkbox"/> startup-config
--------------	------------	--

Note: The switch will stop responding while saving the current configuration to flash.

[Save Settings to Flash](#)

Router Ports

Network > IGMP Snooping > Router Port

1. Log into your switch management page (see "[Access your switch management page](#)" on page 5).

2. Click on **Network**, click on **IGMP Snooping**, and click on **Router Port**.

3. Review the settings. Click **Apply** to save the settings.

In the VLAN ID router port list, you can configure your Static and Dynamic Router ports. IGMP Snooping Router Port configured manually is a **Static Router Port**, and a **Dynamic Router Port** is dynamically configured by the Switch when a query control message is received.

To modify an entry, click **Modify** to add statically add router ports.

Router Port Table			
VLAN ID	Static Router Port	Dynamic Router Port	Action
1	N/A	N/A	Modify

Page 1/1 [First Page](#) [Previous Page](#) [Next Page](#) [Last Page](#) Page [GO](#)

Check the static router ports to add and click **Apply** to save the settings.

Note: You can click on **All** to add all ports. Clicking **Restore** will restore the static router port settings to default.

IGS Static Router Port Settings										
802.1Q VLAN ID:	1									
Static Router Port										
	1	2	3	4	5	6	7	8	9	10
All	<input type="checkbox"/>	<input type="checkbox"/>	<input type="checkbox"/>	<input type="checkbox"/>	<input type="checkbox"/>	<input type="checkbox"/>	<input type="checkbox"/>	<input type="checkbox"/>	<input type="checkbox"/>	<input type="checkbox"/>

4. At the bottom of the left hand panel, click **Save**.

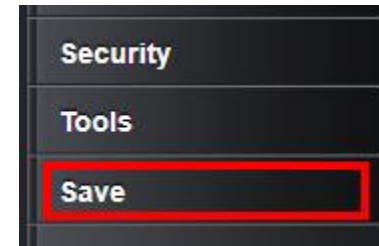

5. Select the Config you would like to save the settings to, click **Save Settings to Flash**, then click **OK**.

Note: This step saves all configuration changes to the NV-RAM to ensure that if the switch is rebooted or power cycled, the configuration changes will still be applied.

Save Settings to Flash		
Config File:	<input type="text" value="Config 1"/>	<input checked="" type="checkbox"/> startup-config
Note: The switch will stop responding while saving the current configuration to flash.		
Save Settings to Flash		

MLD Snooping

Settings

Network > MLD Snooping > Settings

- Log into your switch management page (see "[Access your switch management page](#)" on page 5).
- Click on **Network**, click on **MLD Snooping**, and click on **Settings**.
- Review the settings. Click **Apply** to save the settings.
 - MLD Snooping Status** – Click the drop-down list and select **Enabled** to enable MLD snooping.
 - Aging Timeout** – Enter the aging timeout in seconds.
 - Querier Status** – Click the drop-down list and select **Enabled** to enable the Querier Election or **Disabled** to disable this feature.
 - Fast Leave Status** – Click the drop-down list and select **Enabled** to enable fast leave or **Disabled** to disable this feature.
 - Query Interval** – Enter the amount of time you want your switch to send queries.
 - Max Response Time** – Enter the maximum response time in seconds that client can wait before responding to a query.
 - Robustness Variable** – Enter the robustness value used to determine the number of times to send a message.
 - Last Member Query Interval** – Enter the interval between the last member queries.
 - Router Timeout** – Enter the amount of time before the router times out.

MLD Snooping Settings	
MLD Snooping Status:	Disabled ▾
Aging Timeout:	260 Sec. (130-153025)
Querier Status:	Disabled ▾
Fast Leave Status:	Disabled ▾
Query Interval:	125 Sec. (60-600)
Max Response Time:	10 Sec. (10-25)
Robustness Variable:	2 Times. (2-255)
Last Member Query Interval:	2 Sec. (1-25)
Router Timeout:	250 Sec. (120-1200)

- At the bottom of the left hand panel, click **Save**.

- Select the Config you would like to save the settings to, click **Save Settings to Flash**, then click **OK**.

Note: This step saves all configuration changes to the NV-RAM to ensure that if the switch is rebooted or power cycled, the configuration changes will still be applied.

Save Settings to Flash	
Config File:	Config 1 ▾ <input checked="" type="checkbox"/> startup-config
Note: The switch will stop responding while saving the current configuration to flash.	
<div style="border: 2px solid red; padding: 5px; display: inline-block; color: white; background-color: #00aaff;">Save Settings to Flash</div>	

Router Port

Network > MLD Snooping > Router Port

1. Log into your switch management page (see “[Access your switch management page](#)” on page 5).
2. Click on **Network**, click on **MLD Snooping**, and click on **Router Port**.
3. Review the settings. Click **Modify** to change the settings. Click **Apply** to save the settings.
 - **VLAN ID** – Shows the VLAN ID.
 - **Static Router Port** – Shows if/what the static router ports are.
 - **Dynamic Router Port** – Shows if/what the dynamic router ports are.

Router Port Table			
VLAN ID	Static Router Port	Dynamic Router Port	Action
1	N/A	N/A	Modify

- **802.1Q VLAN ID** – Shows the VLAN ID.
- **Static Router Port** – Check the box below the port number to set the statically set ports

Router Port Settings										
802.1Q VLAN ID:	1									
Static Router Port										
	1	2	3	4	5	6	7	8	9	10
All	<input type="checkbox"/>	<input type="checkbox"/>	<input type="checkbox"/>	<input type="checkbox"/>	<input type="checkbox"/>	<input type="checkbox"/>	<input type="checkbox"/>	<input type="checkbox"/>	<input type="checkbox"/>	<input type="checkbox"/>

4. At the bottom of the left hand panel, click **Save**.

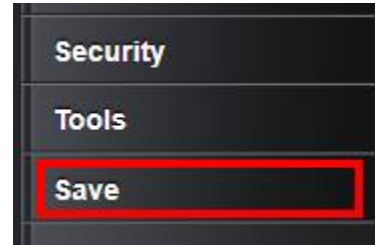

5. Select the Config you would like to save the settings to, click **Save Settings to Flash**, then click **OK**.

Note: This step saves all configuration changes to the NV-RAM to ensure that if the switch is rebooted or power cycled, the configuration changes will still be applied.

Save Settings to Flash

Config File: Config 1 ▾ startup-config

Note: The switch will stop responding while saving the current configuration to flash.

[Save Settings to Flash](#)

Multicast VLAN

Multicast VLAN Settings

Network > Multicast VLAN > Multicast VLAN Settings

1. Log into your switch management page (see "[Access your switch management page](#)" on page 5).
2. Click on **Network**, click on **Multicast VLAN**, and click on **Multicast VLAN Settings**.
3. Review the settings. Click **Apply/Add** to save the settings.
 - **Multicast ipv4 state** – Click the drop-down list and select **Enabled** to enable ipv4 multicast.
 - **Multicast ipv6 state** – Click the drop-down list and select **Enabled** to enable ipv6 multicast.
 - **VLAN ID** – Enter the VLAN ID you would like to assign.
 - **VLAN Name** – Enter the name for this VLAN.

Multicast Global Settings

Multicast ipv4 state: Disabled ▼

Multicast ipv6 state: Disabled ▼

Apply

Multicast VLAN Settings

VLAN ID: (2-4094)

VLAN Name: (32 characters limit)

Add
Delete

The Port Setting of Multicast

VLAN ID	VLAN Name	State	Receiver Ports	Source Ports	Action

4. At the bottom of the left hand panel, click **Save**.
5. Select the Config you would like to save the settings to, click **Save Settings to Flash**, then click **OK**.

Note: This step saves all configuration changes to the NV-RAM to ensure that if the switch is rebooted or power cycled, the configuration changes will still be applied.

Multicast VLAN Table

Network > Multicast VLAN > Multicast VLAN Table

1. Log into your switch management page (see "[Access your switch management page](#)" on page 5).
2. Click on **Network**, click on **Multicast VLAN**, and click on **Multicast VLAN Table**.
3. Review the settings.

Multicast Vlan Table						
VLAN ID	VLAN Name	state	Tagged Receiver Ports	Untagged Receiver Ports	Tagged Source Ports	Untagged Source Ports

Multicast VLAN Group Settings

Network > Multicast VLAN > Multicast VLAN Group Settings

1. Log into your switch management page (see "[Access your switch management page](#)" on page 5).
2. Click on **Network**, click on **Multicast VLAN**, and click on **Multicast VLAN Group Settings**.
3. Review the settings. Click **Add** to save the settings.
 - **Profile Name** – Enter the name you would like to assign.
 - **IP Address Range** – Enter the IP address range.

Profile Create

Profile Name: (32 characters limit)

Add

Group Profile Settings

Profile Name: (32 characters limit)

IP Address Range: . . . / - / IPv4 IPv6

Add
Delete

Multicast Profile Table

Total Entries : 0

Profile Name	Multicast Group Profiles		Action

Page 0/0 [First Page](#) [Previous Page](#) [Next Page](#) [Last Page](#) Page [GO](#)

4. At the bottom of the left hand panel, click **Save**.



5. Select the Config you would like to save the settings to, click **Save Settings to Flash**, then click **OK**.

Note: This step saves all configuration changes to the NV-RAM to ensure that if the switch is rebooted or power cycled, the configuration changes will still be applied.

Save Settings to Flash

Config File: startup-config

Note: The switch will stop responding while saving the current configuration to flash.

Save Settings to Flash

Multicast VLAN Access Settings

Network > Multicast VLAN > Multicast VLAN Access Settings

1. Log into your switch management page (see "[Access your switch management page](#)" on page 5).

2. Click on **Network**, click on **Multicast VLAN**, and click on **Multicast VLAN Access Settings**.

3. Review the settings. Click **Add** to save the settings.

- **VLAN ID** – Enter the VLAN ID you would like to assign.
- **Profile Name** – Enter the name for this profile.

Associate Group Settings

VLAN ID: (2-4094)

Profile Name: (32 characters limit)

Add **Delete**

Multicast Associate Group Table

Multicast Vlan ID	Multicast Profiles Name

4. At the bottom of the left hand panel, click **Save**.

5. Select the Config you would like to save the settings to, click **Save Settings to Flash**, then click **OK**.

Note: This step saves all configuration changes to the NV-RAM to ensure that if the switch is rebooted or power cycled, the configuration changes will still be applied.

Save Settings to Flash

Config File: startup-config

Note: The switch will stop responding while saving the current configuration to flash.

Save Settings to Flash

Multicast Filtering

Multicast Filtering

Network > Multicast VLAN > Multicast VLAN Settings

1. Log into your switch management page (see "[Access your switch management page](#)" on page 5).
2. Click on **Network**, click on **Multicast VLAN**, and click on **Multicast VLAN Settings**.
3. Review the settings. Click **Apply** to save the settings.

- **Multicast Filter Mode** –Select forward or filter multicast traffic on this port.

Multicast Filtering		
Port	Multicast Filter Mode	Action
All	forward ▾	Apply
1	forward ▾	Apply
2	forward ▾	Apply
3	forward ▾	Apply

4. At the bottom of the left hand panel, click **Save**.
5. Select the Config you would like to save the settings to, click **Save Settings to Flash**, then click **OK**.

Note: This step saves all configuration changes to the NV-RAM to ensure that if the switch is rebooted or power cycled, the configuration changes will still be applied.

Save Settings to Flash

Config File: Config 1 ▾ startup-config

Note: The switch will stop responding while saving the current configuration to flash.

[Save Settings to Flash](#)

Bandwidth Control

Storm Control

Network > Bandwidth Control > Storm Control

This section allows you to configure the DLF (Destination Lookup Failure), broadcast, and multicast storm settings for each switch port.

1. Log into your switch management page (see "[Access your switch management page](#)" on page 5).
2. Click on **Network**, click on **Bandwidth Control**, and click on **Storm Control**.
3. Review the settings for each port. Click **Apply** to save the settings.

- **DLF (Destination Lookup Failure)** – Click the drop-down list and select **Enabled** to enable DLF storm control.
- **Broadcast** – Click the drop-down list and select **Enabled** to enable broadcast storm control.
- **Multicast** – Click the drop-down list and select **Enabled** to enable multicast storm control.
- **Threshold** – Enter the pps (packets per second) threshold.

Note: Modifying settings in the row marked **All**, will apply the settings to all ports.

Storm Control Settings					
Port	DLF	Broadcast	Multicast	Threshold	Action
All	Ignore ▾	Ignore ▾	Ignore ▾	64pps x <input type="text"/> (1-4096)	Apply
1	Disabled ▾	Disabled ▾	Disabled ▾	64pps x 4096 (1-4096)	Apply
2	Disabled ▾	Disabled ▾	Disabled ▾	64pps x 4096 (1-4096)	Apply

4. At the bottom of the left hand panel, click **Save**.
5. Select the Config you would like to save the settings to, click **Save Settings to Flash**, then click **OK**.

Note: This step saves all configuration changes to the NV-RAM to ensure that if the switch is rebooted or power cycled, the configuration changes will still be applied.

Ingress Rate Limiting

Network > Bandwidth Control > Ingress Rate Limiting

This section allows you to set the ingress (receive) rate for each switch port.

1. Log into your switch management page (see "[Access your switch management page](#)" on page 5).
2. Click on **Network**, click on **Bandwidth Control**, and click on **Ingress Rate Limiting**.
3. Review the settings for each port. Click **Apply** to save the settings.
 - **Bandwidth** – Enter the ingress rate limit value.
 - **Status** – Click the drop-down list and select **Enabled** to enable ingress rate limiting or select **Disabled** to disable ingress rate limiting.

Note: Modifying settings in the row marked **All**, will apply the settings to all ports.

Ingress Rate Limiting Settings			
Bandwidth = 64kbps x rate limit			
Port	Bandwidth	Status	Action
All	64kbps x <input type="text"/> (1-15625)	Ignore ▾	<input type="button" value="Apply"/>
1	64kbps x <input type="text" value="15625"/> (1-15625)	Enabled ▾	<input type="button" value="Apply"/>
2	64kbps x <input type="text" value="15625"/> (1-15625)	Disabled ▾	<input type="button" value="Apply"/>

4. At the bottom of the left hand panel, click **Save**.
5. Select the Config you would like to save the settings to, click **Save Settings to Flash**, then click **OK**.

Note: This step saves all configuration changes to the NV-RAM to ensure that if the switch is rebooted or power cycled, the configuration changes will still be applied.

Egress Rate Limiting

Network > Bandwidth Control > Egress Rate Limiting

This section allows you to set the egress (transmit) rate for each switch port.

1. Log into your switch management page (see "[Access your switch management page](#)" on page 5).
2. Click on **Network**, click on **Bandwidth Control**, and click on **Egress Rate Limiting**.
3. Review the settings for each port. Click **Apply** to save the settings.
 - **Bandwidth** – Enter the egress rate limit value.
 - **Status** – Click the drop-down list and select **Enabled** to enable egress rate limiting or select **Disabled** to disable egress rate limiting.

Note: Modifying settings in the row marked **All**, will apply the settings to all ports.

Egress Rate Limiting Settings			
Bandwidth = 64kbps x rate limit			
Port	Bandwidth	Status	Action
All	64kbps x <input type="text"/> (1-15625)	Ignore ▾	<input type="button" value="Apply"/>
1	64kbps x <input type="text" value="15625"/> (1-15625)	Disabled ▾	<input type="button" value="Apply"/>
2	64kbps x <input type="text" value="15625"/> (1-15625)	Disabled ▾	<input type="button" value="Apply"/>

4. At the bottom of the left hand panel, click **Save**.
5. Select the Config you would like to save the settings to, click **Save Settings to Flash**, then click **OK**.

Note: This step saves all configuration changes to the NV-RAM to ensure that if the switch is rebooted or power cycled, the configuration changes will still be applied.

VLAN

Tagged

Network > VLAN > Tagged

A VLAN is a group of ports that can be anywhere in the network, but communicate as though they were in the same area.

VLANs can be easily organized to reflect department groups (such as R&D, Marketing), usage groups (such as e-mail), or multicast groups (multimedia applications such as video conferencing), and therefore help to simplify network management by allowing users to move devices to a new VLAN without having to change any physical connections.

1. Log into your switch management page (see "[Access your switch management page](#)" on page 5).
2. Click on **Network**, click on **VLAN**, and click on **Tagged VLAN**.
3. Review the settings.
 - **VLAN ID** – Enter the VLAN ID for the new VLAN.
 - **VLAN Name** – Enter the VLAN name.
 - **Management VLAN** – Click the drop-down list and select **Enabled** to allow access to the switch management page through the new VLAN. If you want to restrict management access through this VLAN, select **Disabled**.

Note: By default, the default VLAN VID 1 is set as the Management VLAN.

Tagged VLAN Settings	
VLAN ID:	<input type="text" value=""/> (2-4094)
VLAN Name:	<input type="text" value=""/> (32 characters limit)
Management VLAN:	Disabled <input type="button" value="v"/>

In the sections **Static Tagged**, **Static Untagged**, and **Not Member**, you can add the type of VLAN ports to add to the new VLAN (Tagged or Untagged) and assign ports that are not members (Forbidden) of the new VLAN.

Tagged/Untagged/Not Member VLAN Ports

On a port, the tag information within a frame is examined when it is received to determine if the frame is qualified as a member of a specific tagged VLAN. If it is, it is eligible to be switched to other member ports of the same VLAN. If it is determined that the frame's tag does not conform to the tagged VLAN, the frame is discarded.

Since these VLAN ports are VLAN aware and able to read VLAN VID tagged information on a frame and forward to the appropriate VLAN, typically tagged VLAN ports are used for uplink and downlink to other switches to carry and forward traffic for multiple VLANs across multiple switches. Tagged VLAN ports can be included as members for multiple VLANs. Computers and other edge devices are not typically connected to tagged VLAN ports unless the network interface on these device can be enabled to be VLAN aware.

Select the tagged VLAN ports to add to the new VLAN.

Static Tagged										
	1	2	3	4	5	6	7	8	9	10
All	<input type="radio"/>	<input type="radio"/>	<input type="radio"/>	<input type="radio"/>	<input type="radio"/>	<input type="radio"/>	<input type="radio"/>	<input type="radio"/>	<input type="radio"/>	<input type="radio"/>
	11	12	13	14	15	16	17	18	19	20
	<input type="radio"/>	<input type="radio"/>	<input type="radio"/>	<input type="radio"/>	<input type="radio"/>	<input type="radio"/>	<input type="radio"/>	<input type="radio"/>	<input type="radio"/>	<input type="radio"/>

Untagged VLAN ports are used to connect edge devices (VLAN unaware) such as computers, laptops, and printers to a specified VLAN. It is required to modify the Port VID settings accordingly for untagged VLAN ports under Bridge > VLAN > Port Settings. (e.g. If the VID for the VLAN is 2, the PVID should also be set to 2)

Select the untagged VLAN ports to add to the new VLAN.

Static Untagged										
	1	2	3	4	5	6	7	8	9	10
All	<input type="radio"/>	<input type="radio"/>	<input type="radio"/>	<input type="radio"/>	<input type="radio"/>	<input type="radio"/>	<input type="radio"/>	<input type="radio"/>	<input type="radio"/>	<input type="radio"/>
	11	12	13	14	15	16	17	18	19	20
	<input type="radio"/>	<input type="radio"/>	<input type="radio"/>	<input type="radio"/>	<input type="radio"/>	<input type="radio"/>	<input type="radio"/>	<input type="radio"/>	<input type="radio"/>	<input type="radio"/>

Select the not member ports to restrict from the new VLAN.

Not Member										
	1	2	3	4	5	6	7	8	9	10
All	<input type="radio"/>	<input type="radio"/>	<input type="radio"/>	<input type="radio"/>	<input type="radio"/>	<input type="radio"/>	<input type="radio"/>	<input type="radio"/>	<input type="radio"/>	<input type="radio"/>
	11	12	13	14	15	16	17	18	19	20
	<input type="radio"/>	<input type="radio"/>	<input type="radio"/>	<input type="radio"/>	<input type="radio"/>	<input type="radio"/>	<input type="radio"/>	<input type="radio"/>	<input type="radio"/>	<input type="radio"/>

Click **Apply** to save the new VLAN to the table.

In the list, you can click **Modify** to modify an entry or click **Delete** or delete the entry. If the entries span multiple pages, you can navigate page number in the **Page** field and click **Go** or you can click **First**, **Previous**, **Next**, and **Last Page** to navigate the pages.

Note: The default VLAN VID1 cannot be removed.

Tagged VLAN Table			
VLAN ID	Name	VLAN Type	Action
1	DefaultVLAN	Permanent	Modify

Note: If a port does not belong to any VLAN, its PVID will be changed to default VLAN ID and attends to default VLAN automatically.

Page 1/1 **First Page** **Previous Page** **Next Page** **Last Page** Page **GO**

4. At the bottom of the left hand panel, click **Save**.

5. Select the Config you would like to save the settings to, click **Save Settings to Flash**, then click **OK**.

Note: This step saves all configuration changes to the NV-RAM to ensure that if the switch is rebooted or power cycled, the configuration changes will still be applied.

Port

Network > VLAN > Port

In this section, you can modify the port VID settings, acceptable frame types, and ingress filtering.

1. Log into your switch management page (see "[Access your switch management page](#)" on page 5).
2. Click on **Bridge**, click on **VLAN**, and click on **Port Settings**.

3. Review the settings for each port. Click **Apply** to save settings.

- **PVID** – Enter the port VLAN ID. **Note:** Required for untagged VLAN ports.
- **Acceptable Frame Type** – Click the drop-down list and select which type of frames can be accepted.
 - **All** – The port can accept all frame types.
 - **Tagged** – The port can accept tagged frames only. Untagged frames are discarded.
 - **Untagged & Priority Tagged** – The port can accept untagged frames and frames with tagged priority information only such as 802.1p.
- **Ingress Filtering** – Click the drop-down list and select **Enabled** to enable ingress filtering or **Disabled** to disable ingress filtering.

Note: Modifying settings in the row marked **All**, will apply the settings to all ports.

Port Settings				
Port	PVID	Acceptable Frame Types	Ingress Filtering	Action
All	<input type="text"/>	Ignore	Ignore	Apply
1	1	All	Enabled	Apply
2	1	All	Enabled	Apply

4. At the bottom of the left hand panel, click **Save**.

5. Select the Config you would like to save the settings to, click **Save Settings to Flash**, then click **OK**.

Forwarding

Network > VLAN > Forwarding

This section allows you to configure your switch to standard 802.1Q VLAN mode (IVL) or Asymmetric VLAN mode (SVL). Asymmetric VLAN allows the configuration of overlapping untagged VLAN ports in order to create VLAN groups. It is recommended to use the standard 802.1Q VLAN mode when possible.

IVL – Independent VLAN Learning

SVL – Shared VLAN Learning (also known as asymmetric VLAN)

Please note the following when switching between forwarding table modes:

- FDB (Forwarding Database) will be cleared.
- Static Unicast Address entries will be cleared.
- Static Multicast Address entries will be cleared.
- 802.1X authenticated records will be cleared.
- IGMP Snooping multicast group addresses will be cleared
- When using SVL mode, Voice VLAN will not be supported.
- When using SVL mode, the VID field on 802.1Q-VLAN mode will be displayed as "N/A".

1. Log into your switch management page (see "[Access your switch management page](#)" on page 5).
2. Click on **Network**, click on **VLAN**, and click on **Forwarding**.
3. Click the learning mode drop-down list to select the forwarding table mode and click **Apply** to save settings.

Note: The default mode is IVL.

Forwarding Table Mode Settings

Learning Mode: IVL ▾

4. At the bottom of the left hand panel, click **Save**.
5. Select the Config you would like to save the settings to, click **Save Settings to Flash**, then click **OK**.

Dynamic

Network > VLAN > Dynamic

This section allows you to view the VLAN forwarding table with dynamically generated forwarding table entries as devices more devices are connected to your switch.

1. Log into your switch management page (see "[Access your switch management page](#)" on page 5).
2. Click on **Network**, click on **VLAN**, and click on **Dynamic**.
3. By default, forwarding entries for all ports are listed. You can click the **Port** drop-down list to select a specific port to view only the forwarding entries for the selected port.

If the entries span multiple pages, you can navigate page number in the **Page** field and click **Go** or you can click **First**, **Previous**, **Next**, and **Last Page** to navigate the pages.

Dynamic Forwarding Table Settings

Port: All ▾

Refresh

Dynamic Forwarding Table

ID	VID	Port	MAC Address	Type
1	1	20	A4-D1-D2-4A-83-95	Dynamic
2	1	20	B8-C7-5D-DA-0C-88	Dynamic
3	1	20	D8-EB-97-EF-32-6A	Dynamic
4	1	20	EC-0E-C4-12-B9-C1	Dynamic

Page 1/1 First Page Previous Page Next Page Last Page Page GO

4. At the bottom of the left hand panel, click **Save**.
5. Select the Config you would like to save the settings to, click **Save Settings to Flash**, then click **OK**.

Private

Network > VLAN > Private

The private VLAN feature allows you to create a more secure VLAN that is completely isolated to its members and cannot communicate with other VLANs. A private VLAN partitions the Layer 2 broadcast domain of a VLAN into subdomains, allowing you to isolate the ports on the switch from each other. A subdomain consists of a primary VLAN and one or more secondary VLANs. All VLANs in a private VLAN domain share the same primary VLAN. The secondary VLAN ID differentiates one subdomain from another. The secondary VLANs may either be isolated VLANs or community VLANs. A host on an isolated VLAN can only communicate with the associated promiscuous port in its primary VLAN. Hosts on community VLANs can communicate among themselves and with their associated promiscuous port but not with ports in other community VLANs.

The following guidelines apply when configuring private VLANs: The default VLAN 1 cannot be a private VLAN. The management VLAN 4095 cannot be a private VLAN. The management port cannot be a member of a private VLAN. IGMP Snooping must be disabled on isolated VLANs. Each secondary port's (isolated port and community ports) PVID must match its corresponding secondary VLAN ID. Ports within a secondary VLAN cannot be members of other VLANs. All VLANs that make up the private VLAN must belong to the same Spanning Tree Group.

1. Log into your switch management page (see "[Access your switch management page](#)" on page 5).
2. Click on **Network**, click on **VLAN**, and click on **Private**.
3. To configure Private VLAN Settings, perform the following procedure:
 - Select Private VLAN status from the **Status** radio button choices that you want to change.
 - **Enable**: Enable Private VLAN settings.
 - **Disable**: Disable Private VLAN settings.
 - Press **Apply** for changes to take effect.
 - Set the **Source Port** to one of the following choices from the pull-down menu: All, 01 – 10

- Click on the **Forwarding Ports** ratio button that applies to your configuration.
- Click **Apply**.

Private VLAN Settings

Private VLAN Status: Disabled ▾

Apply

Port Select

Source Port: 01 ▾

Forwarding Ports:

	1	2	3	4	5	6	7	8	9	10
Clear	<input checked="" type="checkbox"/>	<input checked="" type="checkbox"/>	<input checked="" type="checkbox"/>	<input checked="" type="checkbox"/>	<input checked="" type="checkbox"/>	<input checked="" type="checkbox"/>	<input checked="" type="checkbox"/>	<input checked="" type="checkbox"/>	<input checked="" type="checkbox"/>	<input checked="" type="checkbox"/>
	11	12	13	14	15	16	17	18	19	20
	<input checked="" type="checkbox"/>	<input checked="" type="checkbox"/>	<input checked="" type="checkbox"/>	<input checked="" type="checkbox"/>	<input checked="" type="checkbox"/>	<input checked="" type="checkbox"/>	<input checked="" type="checkbox"/>	<input checked="" type="checkbox"/>	<input checked="" type="checkbox"/>	<input checked="" type="checkbox"/>

Apply

Port List

Port	Port Map
1	1-20
2	1-20
3	1-20
4	1-20
5	1-20
6	1-20

4. At the bottom of the left hand panel, click **Save**.
5. Select the Config you would like to save the settings to, click **Save Settings to Flash**, then click **OK**.

Note: This step saves all configuration changes to the NV-RAM to ensure that if the switch is rebooted or power cycled, the configuration changes will still be applied.

Current

Network > VLAN > Current

1. Log into your switch management page (see "[Access your switch management page](#)" on page 5).
2. Click on **Network**, click on **VLAN**, and click on **Current**.
3. View the current VLAN database in the table.

If the entries span multiple pages, you can navigate page number in the **Page** field and click **Go** or you can click **First**, **Previous**, **Next**, and **Last Page** to navigate the pages.

802.1Q Tagged VLAN					
VLAN ID	VLAN Name	VLAN FDB ID	Member Ports	Untagged Ports	Status
1	DefaultVLAN	1	1-20	1-20	permanent

Page 1/1 [First Page](#) [Previous Page](#) [Next Page](#) [Last Page](#) Page [GO](#)

4. At the bottom of the left hand panel, click **Save**.
5. Select the Config you would like to save the settings to, click **Save Settings to Flash**, then click **OK**.

Note: This step saves all configuration changes to the NV-RAM to ensure that if the switch is rebooted or power cycled, the configuration changes will still be applied.

Save Settings to Flash

Config File: startup-config

Note: The switch will stop responding while saving the current configuration to flash.

[Save Settings to Flash](#)

GVRP**GVRP Global Settings**

Network > GVRP > GVRP Global Settings

The GARP VLAN Registration Protocol (GVRP) allows network devices to share VLAN information and to use the information to modify existing VLANs or create new VLANs, automatically. This makes it easier to manage VLANs that span more than one switch. Without GVRP, you have to manually configure your switches to ensure that the various parts of the VLANs can communicate with each other across the different switches. With GVRP, which is an application of the Generic Attribute Registration Protocol (GARP), this is done for you automatically.

1. Log into your switch management page (see "[Access your switch management page](#)" on page 5).
2. Click on **Network**, click on **GVRP**, and click on **GVRP Global Settings**.
3. Click the **GVRP Status** drop-down list and select **Enabled** to activate GVRP or disabled to deactivate GVRP. Click **Apply** to save the settings.

GVRP Global Settings

GVRP Status:

4. At the bottom of the left hand panel, click **Save**.
5. Select the Config you would like to save the settings to, click **Save Settings to Flash**, then click **OK**.

Note: This step saves all configuration changes to the NV-RAM to ensure that if the switch is rebooted or power cycled, the configuration changes will still be applied.

Save Settings to Flash

Config File: startup-config

Note: The switch will stop responding while saving the current configuration to flash.

[Save Settings to Flash](#)

Port Settings

Network > GVRP > Port Settings

This section will allow you to select which ports will have GVRP enabled or will be restricted from using GVRP.

- Log into your switch management page (see "[Access your switch management page](#)" on page 5).
- Click on **Network**, click on **GVRP** and click on **Port Settings**.
- Review the settings for each port. Click **Apply** to save the settings.
 - Port** - This parameter displays the ports on the switch.
 - Dynamic Vlan Status** - This parameter defines the GVRP status of the port. From the **Dynamic Vlan Status** field, select one of the following choices from the pull-down menu:
 - Ignore** - This parameter indicates that the setting in the **All** row does not apply to the **Dynamic Vlan Status** field. In other words, each port is set individually.
 - Enable** - The **Dynamic Vlan** is activated for the port row selected.
 - Disable** - The **Dynamic Vlan** is de-active for the port row selected.
 - Restricted VLAN Registration** - This parameter controls if the VLAN registration on the port is restricted or not.
 - Ignore** - This parameter indicates that the setting in the **All** row does not apply to the **Restricted VLAN Registration** field. In other words, each port is set individually.
 - Enable** - The **Restricted VLAN Registration** is active for the port row selected.
 - Disable** - The **Restricted VLAN Registration** is de-active for the port row selected.

GVRP Port Settings

Port	Dynamic Vlan Status	Restricted VLAN Registration	Action
All	Ignore ▾	Ignore ▾	Apply
1	Enabled ▾	Disabled ▾	Apply
2	Enabled ▾	Disabled ▾	Apply
3	Enabled ▾	Disabled ▾	Apply

- At the bottom of the left hand panel, click **Save**.

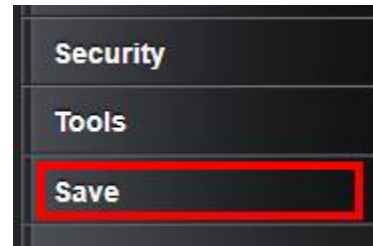

- Select the Config you would like to save the settings to, click **Save Settings to Flash**, then click **OK**.

Note: This step saves all configuration changes to the NV-RAM to ensure that if the switch is rebooted or power cycled, the configuration changes will still be applied.

Save Settings to Flash

Config File: Config 1 ▾ startup-config

Note: The switch will stop responding while saving the current configuration to flash.

Save Settings to Flash

Time Settings

Network > GVRP > Time Settings

This section will allow you to define the GARP Join, Leave, and Leave All Time for each port.

Note: The *GARPLLeaveTimer* must be greater than (*GARPJoinTimer* x 2 + 10) and the *GARPLLeaveAllTimer* must be greater than (*GARPLLeaveTimer* + 10). The acceptable input values are multiples of 10. If you try to enter a value that is not a multiple of 10, the value is rounded down

1. Log into your switch management page (see "[Access your switch management page](#)" on page 5).
2. Click on **Network**, click on **GVRP** and click on **Time Settings**.
3. Review the settings for each port. Click **Apply** to save the settings.
 - **Port** - This parameter displays the ports on the switch.
 - **JoinTime** - This parameter is the GARP Join Timer. Its range is 10 - 1073741810 milli-seconds.
 - **LeaveTime** - This parameter is the GARP Leave Timer. Its range is 30 - 2147483630 milli-seconds. This timer must be set in relation to the GVRP Join Timer according to the following equation:

$$\text{GARPLLeaveTimer} \geq (\text{GARPJoinTimer} \times 2) + 10$$
 - **LeaveAllTime** - This parameter is the GARP Leave All Timer. Its range is 40 - 2147483630 milli-seconds. This timer must be set in relation to the GVRP Leave Timer according to the following equation:

$$\text{GARPLLeaveAllTimer} > (\text{GARPLLeaveTimer} + 10)$$

Note: To ensure compatibility between network devices, you need to configure the same values for the GARP Join Timer, GARP Leave Timer, and GARP Leave All Timer on all participating GVRP devices in your network.

GVRP Time Settings

Port	JoinTime (10 ~ 2 ³⁰ -14) msec	LeaveTime (30 ~ 2 ³¹ -18) msec	LeaveAllTime (40 ~ 2 ³¹ -8) msec	Action
All	<input type="text"/>	<input type="text"/>	<input type="text"/>	<input type="button" value="Apply"/>
1	<input type="text" value="200"/>	<input type="text" value="600"/>	<input type="text" value="10000"/>	<input type="button" value="Apply"/>
2	<input type="text" value="200"/>	<input type="text" value="600"/>	<input type="text" value="10000"/>	<input type="button" value="Apply"/>

4. At the bottom of the left hand panel, click **Save**.

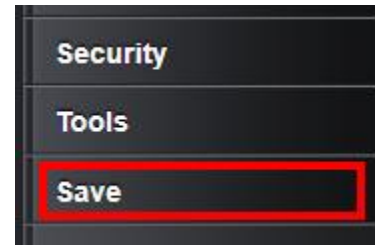

5. Select the Config you would like to save the settings to, click **Save Settings to Flash**, then click **OK**.

Note: This step saves all configuration changes to the NV-RAM to ensure that if the switch is rebooted or power cycled, the configuration changes will still be applied.

Save Settings to Flash

Config File:

Config 1 ▾

startup-config

Note: The switch will stop responding while saving the current configuration to flash.

Voice VLAN

This chapter contains a description of the Switch's Voice VLAN feature and the procedures to create, modify, and delete a voice VLAN configuration.

The Voice VLAN feature is specifically designed to maintain high quality, uninterrupted voice traffic through the switch. When talking on a voice over IP phone, a user expects to have no interruptions in the conversation and excellent voice quality. The Voice VLAN feature can be configured to meet these requirements.

CoS with Voice VLAN

The Voice VLAN CoS parameter maintains the voice quality between the ingress and egress ports of the switch. CoS must be enabled for the Voice VLAN CoS priority to take effect. The CoS priority level that you config is applied to voice traffic on all ports of the voice VLAN. Normally, most (non-Voice) Ethernet traffic transverses the switch through lower order egress queues. To avoid delays and interruptions in the voice data flow, the CoS priority level assigned to the voice VLAN should be mapped to a higher order queue and the scheduling algorithm should be set to Strict Priority. These settings ensure that the voice data packets are processed before other types of data so that the voice quality is maintained as the voice data passes through the switch.

Organization Unique Identifier (OUI)

Each IP phone manufacturer can be identified by one or more Organization Unique Identifiers (OUIs). An OUI is three bytes long and is usually expressed in hexadecimal format. It is imbedded into the first part of each MAC address of an Ethernet network device. You can find the OUI of an IP phone in the first three complete bytes of its MAC address.

Typically, you will find that all of the IP phones you are installing have the same OUI in common. The switch identifies a voice data packet by comparing the OUI information in the packet's source MAC address with an OUI table that you configure when you initially set up the voice VLAN. This is important when the Auto-Detection feature for a port and is a dynamic voice VLAN port.

When you are configuring the voice VLAN parameters, you must enter the complete MAC address of at least one of your IP phones. An "OUI Mask" is automatically generated and applied by the Web Management Utility software to yield the manufacturer's OUI. If the OUI of the remaining phones from that manufacturer is the same, then no other IP phone MAC addresses need to be entered into the configuration.

However, it is possible that you can find more than one OUI from the same manufacturer among the IP phones you are installing. It is also possible that your IP phones are from two or more different manufacturers in which case you will find different OUIs for each manufacturer. If you identify more than one OUI among the IP phones being installed, then one MAC address representing each individual OUI must be configured in the voice VLAN. You can enter a total of 10 OUIs.

Dynamic Auto-Detection vs Static Ports

Prior to configuring the voice VLAN, you must configure a tagged VLAN which is the basis for the voice VLAN configuration. The VLAN must be configured with one or more tagged or untagged ports that will serve as the voice VLAN uplink/downlink. By default, a tagged or untagged port is a static member of a tagged VLAN. The ports that you choose to configure as dynamic Auto-Detection ports

must be connected directly to an IP phone. When you initially define the ports of a tagged VLAN for your voice VLAN configuration, they must be configured as a "Not Member" ports. The "Not Member" ports are eligible to dynamically join the voice VLAN when voice data is detected with a predefined OUI in the source MAC address. The port will leave the voice VLAN after a specified timeout period. This port behavior is configured with the voice VLAN Auto-Detection feature.

For the Auto-Detection feature to function, your IP phone(s) must be capable of generating 802.1Q packets with imbedded VLAN ID tags. You must manually configure your IP phone(s) for the same VLAN ID as the switch's voice VLAN ID. When voice data is detected on one of the "Not Member" ports, the packets from the IP phone will contain the voice VLAN ID so they are switched within the switch's voice VLAN.

One or more ports in your voice VLAN must be configured as Static tagged or untagged members. Static VLAN members are permanent member ports of the voice VLAN and there is no dependency on the configuration of the devices connected to the ports. These ports might be connected to other voice VLAN network nodes such as other Ethernet switches, a telephone switch, or a DHCP server. The voice VLAN Auto-Detection feature cannot be enabled on Static tagged or tagged ports.

Note: Any Static tagged members of the voice VLAN are required to have the port VLAN ID (PVID) configured to be the same as the voice VLAN ID. This insures that all untagged packets entering the port are switched within the voice VLAN as the voice data passes through the switch.

If the IP phone(s) that you are installing cannot be configured with a VLAN ID, then the switch ports should be configured as Static tagged ports within the voice VLAN.

Note: Link Layer Discovery Protocol for Media Endpoint Devices (LLDP- MED) is not supported on the switch. Each IP phone that is VLAN aware should be manually configured for the VLAN ID that matches your voice VLAN ID. Each of the voice VLAN ports connected to an IP phone should be configured as "Not Member" ports of the tagged VLAN.

Settings

Network > Voice VLAN > Settings

Note: Prior to configuring your voice VLAN, you must first configure a tagged VLAN. This VLAN will be used as a basis for your voice VLAN.

1. Log into your switch management page (see "[Access your switch management page](#)" on page 5).

2. Click on **Network**, click on **Voice VLAN**, and click on **Settings**.

3. Review the settings.

Use the following procedure to configure voice VLAN:

- From the **Voice VLAN** field at the top of the page, select one of the following radio button choices:
 - **Enable** - The voice VLAN feature is active. The other parameter fields in the voice VLAN Global Settings section become active and are eligible for data to be entered.
 - **Disable** - The voice VLAN feature is inactive. The other parameter fields in the voice VLAN Global Settings section become inactive and are greyed out so that data cannot be entered.
- In the Voice VLAN Global Settings section, enter the configuration information for the following parameters:
 - **VLAN ID** - This parameter is the tagged VLAN ID that has been configured in "Tagged VLAN Configuration". It is a pull-down menu showing the tagged VLAN IDs that have been defined.
 - **Aging Time** - This parameter indicates the amount of time, in hours, after the last IP phone's OUI was received on a port, after which this

port will be removed from the voice VLAN. The range is 1 to 120 hours.

- **CoS** - This parameter is CoS priority level assigned to the voice data packets received on each voice VLAN port. For the **COS** priority to be effective, QoS must be **Enabled**.

Click **Apply** to save the settings.

Voice VLAN Status	
Voice VLAN Status:	Enabled ▾
Note: Disabling will turn off the function and return all values to default.	
Voice VLAN Global Settings	
VLAN ID:	1 ▾
Aging Time:	1 (1-120 hours)
CoS:	7 ▾

- In the table at the bottom of the page, The voice VLAN **Auto-Detection** status is defined. From the **Auto-Detection** column, select one of the port rows and then one of the following choices from the pull-down menu:
 - **Ignore** - This parameter indicates that the setting in the **All** row does not apply to the **Dynamic Vlan Status** field. In other words, each port is set individually.
 - **Enable** - The voice VLAN **Auto-Detection** feature is activated for the port row selected.
 - **Disable** - The voice VLAN **Auto-Detection** feature is active for the port row selected.

Note: The voice VLAN Auto-Detection feature can only be enabled on "Not Member" ports of the voice VLAN. Member ports cannot have the voice VLAN Auto-Detection feature enabled. The **Status** column displays **Static** for the member ports

Voice VLAN Table			
Port	Auto Detection	Status	Action
All	Ignore ▾	-	Apply
1	Disabled ▾	None	Apply
2	Disabled ▾	None	Apply

4. At the bottom of the left hand panel, click **Save**.



5. Select the Config you would like to save the settings to, click **Save Settings to Flash**, then click **OK**.

Note: This step saves all configuration changes to the NV-RAM to ensure that if the switch is rebooted or power cycled, the configuration changes will still be applied.

Save Settings to Flash

Config File: startup-config

Note: The switch will stop responding while saving the current configuration to flash.

Save Settings to Flash

OUI

Network > Voice VLAN > OUI

1. Log into your switch management page (see "[Access your switch management page](#)" on page 5).

2. Click on **Network**, **Voice VLAN**, and click on **OUI**.

3. Review the settings.

Use the following procedure to configure voice VLAN OUIs:

- Enter a text description that helps you identify the manufacturer's OUI in the **User Defined OUI - Description** field. This parameter can be up to 20 characters in length.
- Enter the MAC address in the **User Defined OUI - Telephony OUI** field of one of the IP phones with the manufacturer's OUI.
- Click **Add**. The new OUI entry is displayed in the table at the bottom of the page.

Note: If you find more than one OUI among the IP phones you are installing, enter one MAC address that represents each individual OUI. You can enter a total of 10 OUIs.

Voice VLAN OUI Settings

	Description	Telephony OUI
User defined OUI:	<input type="text"/>	<input type="text"/> : <input type="text"/> : <input type="text"/> : <input type="text"/> : <input type="text"/> : <input type="text"/> (XX:XX:XX:XX:XX:XX)

Note: 10 maximum user defined OUI allowed.

Modify OUI Setting

To modify or delete an OUI, it must be first be deleted and then re-created.

Delete OUI Setting

To delete a specific OUI that had already been entered in the table at the bottom of the page, click on **Delete** in the **Action** column of the table. The specific OUI will be deleted from the table.

Voice VLAN OUI Table				
Free Policies: 200				
ID	Description	Telephony OUI	OUI Mask	Action
< < Voice VLAN OUI List is empty > >				

4. At the bottom of the left hand panel, click **Save**.



5. Select the Config you would like to save the settings to, click **Save Settings to Flash**, then click **OK**.

Note: This step saves all configuration changes to the NV-RAM to ensure that if the switch is rebooted or power cycled, the configuration changes will still be applied.

Save Settings to Flash		
Config File:	Config 1 ▾	<input checked="" type="checkbox"/> startup-config
Note: The switch will stop responding while saving the current configuration to flash.		
Save Settings to Flash		

LLDP

Enable and configure LLDP

Link Layer Discovery Protocol (LLDP) allows Ethernet network devices, such as switches and routers, to receive and transmit device-related information to directly connected devices on the network and to store data that is learned about other devices.

Settings

Network > LLDP > Settings

1. Log into your switch management page (see "[Access your switch management page](#)" on page 5).
2. Click on **Network**, click on **LLDP**, and click on **Settings**.
3. Review the settings.

Enabling or Disabling LLDP

- From the **LLDP** parameter, select one of the following radio button choices and click **Apply** to save the settings.
 - **Enable:** The LLDP feature is active.
 - **Disable:** The LLDP feature is inactive.

LLDP Global Settings	
LLDP Status:	Enabled ▾

LLDR-MED Parameter Settings:

Fast Start Repeat Count: Enter the number of tries to start.

LLDP-MED Parameter Settings	
Fast Start Repeat Count:	3 times. (1-10)
Apply	

Configure the LLDP Parameter Settings

Message TX Hold Multiplier: Sets the hold multiplier value. The hold time multiplier is multiplied by the transmit interval to give the Time To Live (TTL) that the switch advertises to the neighbors. The range is from 2 to 10.

Message TX Interval: Sets the transmit interval, which is the interval between regular transmissions of LLDP advertisements. The range is from 5 to 32768 seconds.

LLDP Reinit Delay: Sets the reinitialization delay, which is the number of seconds that must elapse after LLDP is disabled on a port before it can be reinitialized. The range is from 1 to 10 seconds.

LLDP TX Delay: Sets the value of the transmission delay timer, which is the minimum time interval between transmissions of LLDP advertisements due to a change in LLDP local information. The range is from 1 to 8192 seconds.

LLDP Parameter Settings	
Message TX Hold Multiplier:	<input type="text" value="4"/> (2-10)
Message TX Interval:	<input type="text" value="30"/> sec. (5-32768)
LLDP Reinit Delay:	<input type="text" value="2"/> sec. (1-10)
LLDP TX Delay:	<input type="text" value="2"/> sec. (1-8192)
Note : (LLDP TX Delay) <= (0.25* (Message TX Interval)) and (Message TX Interval) * (Message TX Hold Multiplier) < 65535.	

Click **Apply** to save the settings.

View LLDP System Information

- **Chassis ID Subtype:** This parameter describes the Chassis ID subtype which is "macAddress". You cannot change this parameter.
- **Chassis ID:** This parameter lists the MAC Address of the switch.
- You cannot change this parameter.
- **System Name:** This parameter lists the System Name of the switch. You can assign the system name.
- **System Description:** This parameter lists the product name of the switch. You cannot change this parameter

LLDP System Information	
Chassis ID Subtype:	macAddress
Chassis ID:	00:01:02:03:04:05
System Name:	
System Description:	

Set LLDP Port State

For each port, click the **State** drop-down list and choose from the following options.

- **Disabled:** Indicates LLDP is disabled on the port. The port cannot receive or transmit LLDP data packets.
- **RxTx:** Indicates LLDP is enabled on the port. The port can receive and transmit LLDP data packets.
- **RxOnly:** Indicates LLDP is enabled on the port. The port can receive LLDP data packets.
- **TxOnly:** Indicates LLDP is enabled on the port. The port can transmit LLDP data packets.

Note: You can select the row labeled **ALL** to apply settings to all ports.

Click **Apply** to save the settings.

LLDP Port State Settings		
Port	State	Action
All	Disabled ▾	Apply
1	RxTx ▾	Apply
2	RxTx ▾	Apply

- At the bottom of the left hand panel, click **Save**.



- Select the Config you would like to save the settings to, click **Save Settings to Flash**, then click **OK**.

Note: This step saves all configuration changes to the NV-RAM to ensure that if the switch is rebooted or power cycled, the configuration changes will still be applied.

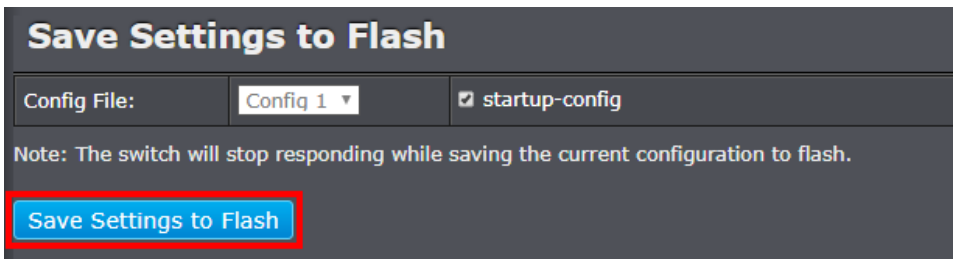

Basic TLVs Settings

Network > LLDP > Basic TLVs Settings

- Log into your switch management page (see "[Access your switch management page](#)" on page 5).
- Click on **Network**, click on **LLDP**, and click on **Basic TLVs Settings**.
- Configure the basic TLVs settings. Click **Apply** to save.
- At the bottom of the left hand panel, click **Save**.
- Select the Config you would like to save the settings to, click **Save Settings to Flash**, then click **OK**.

Dot1 TLVs Settings

Network > LLDP > Dot1 TLVs Settings

- Log into your switch management page (see "[Access your switch management page](#)" on page 5).
- Click on **Network**, click on **LLDP**, and click on **Dot1 TLVs Settings**.
- Configure the Dot1 TLVs settings. Click **Apply** to save.
- At the bottom of the left hand panel, click **Save**.
- Select the Config you would like to save the settings to, click **Save Settings to Flash**, then click **OK**.

Dot3 TLVs Settings

Network > LLDP > Dot1 TLVs Settings

- Log into your switch management page (see "[Access your switch management page](#)" on page 5).
- Click on **Network**, click on **LLDP**, and click on **Dot3 TLVs Settings**.
- Configure the Dot1 TLVs settings. Click **Apply** to save.
- At the bottom of the left hand panel, click **Save**.
- Select the Config you would like to save the settings to, click **Save Settings to Flash**, then click **OK**.

MED Port Settings*Network > LLDP > MED Port Settings*

1. Log into your switch management page (see "[Access your switch management page](#)" on page 5).
2. Click on **Network**, click on **LLDP**, and click on **MED Port Settings**.
3. Configure the MED port settings. Click **Apply** to save.
4. At the bottom of the left hand panel, click **Save**.
5. Select the Config you would like to save the settings to, click **Save Settings to Flash**, then click **OK**.

LLDP Statistics Information*Network > LLDP > LLDP Statistics Information*

1. Log into your switch management page (see "[Access your switch management page](#)" on page 5).
2. Click on **Network**, click on **LLDP**, and click on **LLDP Statistics Information**.
3. View the LLDP Statistics Information. Click **Clear** to clear the counters.

LLDP Local Port Information*Network > LLDP > LLDP Local Port Information*

1. Log into your switch management page (see "[Access your switch management page](#)" on page 5).
2. Click on **Network**, click on **LLDP**, and click on **LLDP Local Port Information**.
3. View the LLDP Local Port Information. Click **Show Details** to for additional info.

Neighbor*Network > LLDP > Neighbor*

1. Log into your switch management page (see "[Access your switch management page](#)" on page 5).
2. Click on **Network**, click on **LLDP**, and click on **Neighbor**.
3. View the LLDP neighbor information.
 - **Entity:** This parameter is a number assigned to the reporting neighbors in the order that the LLDP information is received from them.
 - **Port:** This parameter specifies the switch port number where the LLDP information was received.
 - **Chassis ID Subtype:** This parameter describes the Chassis ID subtype of the neighboring network device which is reporting the LLDP information.
 - **Chassis ID:** This parameter is the neighboring device's chassis ID.
 - **Port ID Subtype:** This parameter describes the Port ID subtype of the neighboring network device's port that is connected directly to the switch port.
 - **Port ID:** This parameter specifies the neighboring network device's port number from which the LLDP information was transmitted.
 - **Port Description:** This parameter describes the neighboring network device's port.
 - **Show Detail:** If you click on this button, a detailed report of the neighboring network device will be displayed.

If the entries span multiple pages, you can navigate page number in the **Page** field and click **Go** or you can click **First**, **Previous**, **Next**, and **Last Page** to navigate the pages.

LLDP Neighbors Information							
Entity	Port	Chassis ID Subtype	Chassis ID	Port ID Subtype	Port ID	Port Description	Show Detail
Page 1/1							
		First Page	Previous Page	Next Page	Last Page	Page <input type="text"/>	GO

MAC VLAN

MAC VLAN

Network > MAC VLAN

- Log into your switch management page (see "[Access your switch management page](#)" on page 5).
- Click on **Network** and click on **MAC VLAN**.
- Configure the MAC VLAN. Click **Add** to save.
 - MAC Address** – Enter the MAC Address to add to the VLAN
 - Description** – Enter a Description.
 - VLAN ID** – Assign a VLAN ID

Create MAC VLAN	
MAC Address:	<input type="text"/> : <input type="text"/> : <input type="text"/> : <input type="text"/> : <input type="text"/> : <input type="text"/> * (XX:XX:XX:XX:XX:XX)
Description:	<input type="text"/> (8 characters maximum)
VLAN ID:	<input type="text"/> (1-4094)
<input type="button" value="Add"/>	

- At the bottom of the left hand panel, click **Save**.
- Select the Config you would like to save the settings to, click **Save Settings to Flash**, then click **OK**.

Note: This step saves all configuration changes to the NV-RAM to ensure that if the switch is rebooted or power cycled, the configuration changes will still be applied.

Save Settings to Flash	
Config File:	<input type="text" value="Config 1"/> <input checked="" type="checkbox"/> startup-config
Note: The switch will stop responding while saving the current configuration to flash.	
<input type="button" value="Save Settings to Flash"/>	

Protocol VLAN

Protocol VLAN Profile

Network > Protocol VLAN > Protocol VLAN Profile

- Log into your switch management page (see "[Access your switch management page](#)" on page 5).
- Click on **Network**, click on **Protocol VLAN**, and click on **Protocol VLAN Profile**.
- Configure the Protocol VLAN. Click **Apply** to save.
 - Profile ID** – Enter the profile ID.
 - Frame Type** – Select a frame type from the drop down.
 - Ether Type** – Assign a Ether Type.

Add Protocol VLAN Profile	
Profile ID	<input type="text"/> (1-16)
Frame Type	<input type="text" value="Ethernet2"/>
Ether Type: 0x	<input type="text"/> (0000-FFFF)
<input type="button" value="Apply"/>	

- At the bottom of the left hand panel, click **Save**.
- Select the Config you would like to save the settings to, click **Save Settings to Flash**, then click **OK**.

Note: This step saves all configuration changes to the NV-RAM to ensure that if the switch is rebooted or power cycled, the configuration changes will still be applied.

Save Settings to Flash	
Config File:	<input type="text" value="Config 1"/> <input checked="" type="checkbox"/> startup-config
Note: The switch will stop responding while saving the current configuration to flash.	
<input type="button" value="Save Settings to Flash"/>	

Protocol VLAN Profile Interface

Network > Protocol VLAN > Protocol VLAN Profile Interface

1. Log into your switch management page (see "[Access your switch management page](#)" on page 5).
2. Click on **Network**, click on **Protocol VLAN**, and click on **Protocol VLAN Profile Interface**.
3. Configure the new Protocol Interface. Click **Apply** to save.
 - **Port** – Select the port number from the dropdown.
 - **Profile ID**– Select the profile ID from the drop down.
 - **VID** – Assign a VID.
 - **Priority** – Select a priority level from the dropdown menu

Add New Protocol VLAN Interface	
Port	1 ▼
Profile ID	▼
VID	<input type="text"/> (1-4094)
Priority	0 ▼

4. At the bottom of the left hand panel, click **Save**.
5. Select the Config you would like to save the settings to, click **Save Settings to Flash**, then click **OK**.

Note: This step saves all configuration changes to the NV-RAM to ensure that if the switch is rebooted or power cycled, the configuration changes will still be applied.

Save Settings to Flash		
Config File:	Config 1 ▼	<input checked="" type="checkbox"/> startup-config

Note: The switch will stop responding while saving the current configuration to flash.

QoS (Quality of Service)

When a port on an Ethernet switch becomes oversubscribed, its egress queues contain more packets than the port can handle in a timely manner. In this situation, the port may be forced to delay the transmission of some packets, resulting in the delay of packets reaching their destinations. A port may be forced to delay transmission of packets while it handles other traffic, and, in some situations, some packets destined to be forwarded to an oversubscribed port from other switch ports may be discarded.

Minor delays are often of no consequence to a network or its performance. But there are applications, referred to as delay or time sensitive applications, which can be impacted by packet delays. Voice transmission and video conferences are two examples. If packets carrying data in either of these cases are delayed from reaching their destination, the audio or video quality may suffer.

This is where Cost of Service (CoS) is of value. It allows you to manage the flow of traffic through a switch by having the switch ports give higher priority to some packets, such as delay sensitive traffic, over other packets. This is referred to as prioritizing traffic.

CoS

Set CoS priority settings

QoS > CoS

Note: Before mapping the CoS priorities and the egress queues, you must disable the **Jumbo** frame parameter on each port. When **Jumbo** frames are enabled, COS cannot be enabled.

1. Log into your switch management page (see "[Access your switch management page](#)" on page 5).
2. Click on **QoS** and click on **CoS**.
3. In **QoS Status**, select **Enabled** and then click **Apply**.
 - For each **Priority** who's Queue ID you want to change, click on the **CoS Table** (1-7, Ignore) radio button that applies to your configuration.
4. Review the settings. Click **Apply** to save the settings.

CoS

QoS Status: Enabled

Apply

CoS Table

Priority	Queue ID	Action
All	0	Apply
0	0	Apply
1	0	Apply
2	0	Apply
3	0	Apply
4	0	Apply
5	0	Apply
6	0	Apply
7	0	Apply

Note: Disable will reset the settings to factory default and turn off the function.

5. At the bottom of the left hand panel, click **Save**.

6. Select the Config you would like to save the settings to, click **Save Settings to Flash**, then click **OK**.

Note: This step saves all configuration changes to the NV-RAM to ensure that if the switch is rebooted or power cycled, the configuration changes will still be applied.

Save Settings to Flash

Config File: Config 1 startup-config

Note: The switch will stop responding while saving the current configuration to flash.

Save Settings to Flash

Port Priority

Set Port Priority

QoS > Port Priority

The Port Priority values are assigned to an untagged frame at ingress for internal processing in the switch. This procedure explains how to change the default mappings of port priorities to the User Priority. This is set at the switch level. You cannot set this at the per-port level. To change the port priority mappings, perform the following procedure.

1. Log into your switch management page (see "[Access your switch management page](#)" on page 5).
2. Click on **QoS** and click on **Port Priority**.
3. For each port whose priority you want to change, select a priority (0-7, Ignore) in the **User Priority** column. Click **Apply** to save the settings.

Port Priority Table		
Port	User Priority	Action
All	0 ▾	Apply
1	0 ▾	Apply
2	0 ▾	Apply

4. At the bottom of the left hand panel, click **Save**.
5. Select the Config you would like to save the settings to, click **Save Settings to Flash**, then click **OK**.

Note: This step saves all configuration changes to the NV-RAM to ensure that if the switch is rebooted or power cycled, the configuration changes will still be applied.

Save Settings to Flash

Config File: Config 1 ▾ startup-config

Note: The switch will stop responding while saving the current configuration to flash.

Save Settings to Flash

DSCP

Set DSCP (Differentiated Services Code Point) Class Mapping settings

QoS > DSCP

If you choose to use the DSCP tags in your Access Control policy configuration, each DSCP value (0-63) that is relevant to your configuration needs to be mapped to one of the four egress queues (Low, Medium, High, or Highest). The default queue for all DSCP values is 0. To assign the queue mappings to the DSCP values, perform the following procedure.

1. Log into your switch management page (see "[Access your switch management page](#)" on page 5).
2. Click on **QoS** and click on **DSCP**.
3. For each DSCP In value that is relevant to your configuration, select a queue (Low, Medium, High, or Highest) in the **Queue** column. Select **Enabled** in the **DSCP Mapping** drop-down list. Click **Apply** to save the settings.

DSCP Priority Mapping Settings

DSCP Mapping Status: Enabled ▾

Apply

DSCP Priority Mapping Table							
DSCP In	Priority	DSCP In	Priority	DSCP In	Priority	DSCP In	Priority
0-15	Ignore ▾	16-31	Ignore ▾	32-47	Ignore ▾	48-63	Ignore ▾
0	0 ▾	16	0 ▾	32	0 ▾	48	0 ▾
1	0 ▾	17	0 ▾	33	0 ▾	49	0 ▾

4. At the bottom of the left hand panel, click **Save**.

Security

Tools

Save

5. Select the Config you would like to save the settings to, click **Save Settings to Flash**, then click **OK**.

Note: This step saves all configuration changes to the NV-RAM to ensure that if the switch is rebooted or power cycled, the configuration changes will still be applied.

Save Settings to Flash

Config File:	Config 1 ▼	<input checked="" type="checkbox"/> startup-config
--------------	------------	--

Note: The switch will stop responding while saving the current configuration to flash.

Save Settings to Flash

Scheduling Algorithm

Set the Scheduling Algorithm

QoS > Scheduling Algorithm

1. Log into your switch management page (see "[Access your switch management page](#)" on page 5).
2. Click on **QoS** and click on **Scheduling Algorithm**.
3. Review the settings. Click **Apply** to save the settings.
 - **Strict Priority** - The port transmits all packets out of higher priority queues before transmitting any from the lower priority queues.
 - **WRR (Weighted RoundRobin)** - The port transmits a set number of packets from each queue, in a round robin fashion, so that each has a chance to transmit traffic.

Scheduling Algorithm Settings

Scheduling Algorithm	Strict Priority ▼
----------------------	-------------------

4. At the bottom of the left hand panel, click **Save**.

5. Select the Config you would like to save the settings to, click **Save Settings to Flash**, then click **OK**.

Note: This step saves all configuration changes to the NV-RAM to ensure that if the switch is rebooted or power cycled, the configuration changes will still be applied.

Save Settings to Flash

Config File:	Config 1 ▼	<input checked="" type="checkbox"/> startup-config
--------------	------------	--

Note: The switch will stop responding while saving the current configuration to flash.

Save Settings to Flash

IPv6 Traffic Class

Configure the IPv6 Traffic Class Settings

QoS > IPv6 Traffic Class

1. Log into your switch management page (see "[Access your switch management page](#)" on page 5).
2. Click on **QoS** and click on **IPv6 Traffic Class Priority Settings**.
3. Review the settings.
 - **IPv6 Traffic Class Global Settings:** Select Enable or Disable. Click **Apply** to save the settings.
 - **IPv6 Traffic Class (0-255):** Specify the value of IPv6 class.
 - **Queue ID (0-7):** Defines the priority assigned to the port. Click **Add** to add the traffic class setting entry to the table.

The screenshot shows two configuration panels. The top panel, titled "IPv6 Traffic Class Global Settings", has a dropdown menu for "IPv6 Traffic Class Status" set to "Disabled" and an "Apply" button. The bottom panel, titled "IPv6 Traffic Class Settings", has input fields for "IPv6 Traffic Class" (empty) and "Queue ID" (set to 0).

In the list, you can click **Modify** to modify an entry or click **Delete** or delete the entry. You can also click **Delete All** to delete all of the entries in the table. If the entries span multiple pages, you can navigate page number in the **Page** field and click **Go** or you can click **First**, **Previous**, **Next**, and **Last Page** to navigate the pages.

The screenshot shows the "IPv6 Traffic Class Table" with a "Delete All" button. Below the table header, it says "Total Entries : 0". The table has columns for "IPv6 Traffic Class", "Queue ID", and "Action". Below the table, there is a message: "<< ipv6 traffic class table is empty >>". At the bottom, there is a pagination bar with buttons for "First Page", "Previous Page", "Next Page", "Last Page", a "Page" field with a value of 0, and a "GO" button.

4. At the bottom of the left hand panel, click **Save**.

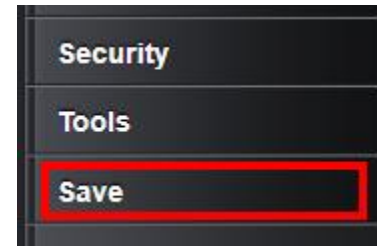

5. Select the Config you would like to save the settings to, click **Save Settings to Flash**, then click **OK**.

Note: This step saves all configuration changes to the NV-RAM to ensure that if the switch is rebooted or power cycled, the configuration changes will still be applied.

The screenshot shows a dialog box titled "Save Settings to Flash". It has a "Config File:" field with a dropdown menu set to "Config 1" and a checked checkbox for "startup-config". Below this, there is a note: "Note: The switch will stop responding while saving the current configuration to flash." At the bottom, there is a "Save Settings to Flash" button highlighted with a red rectangular box.

PoE (Power over Ethernet)

Power over Ethernet

The main advantage of PoE is that it can make installing a network easier. The selection of a location for a network device is often limited by whether there is a power source nearby. This constraint limits equipment placement or requires the added time and cost of having additional electrical sources installed. However, with PoE, you can install PoE compatible devices wherever they are needed without having to worry about whether there is power source nearby.

Power Sourcing Equipment (PSE)

A device that provides PoE to other network devices is referred to as power sourcing equipment (PSE). The Gigabit Web Smart PoE+ Switch is a PSE device which provides DC power to the network cable and functions as a central power source for other network devices.

Powered Device (PD)

A device that receives power from a PSE device is called a *powered device* (PD). Examples include wireless access points, IP phones, webcams, and even other Ethernet switches.

PD Classes PDs are grouped into five classes. The classes are based on the amount of power that PDs require. The Gigabit Web Smart PoE+ Switch supports all five classes.

Class	Maximum Power Output from a Switch Port	Power Ranges of the PDs
0	15.4W	0.44W to 12.95W
1	4.0W	0.44W to 3.84W
2	7.0W	3.84W to 6.49W
3	15.4W	6.49W to 12.95W
4	34.2W	12.85W to 25.5W

Power Budget

Power budget is the maximum amount of power that the PoE switch can provide at one time to the connected PDs. Port Prioritization As long as the total power requirements of the PDs is less than the total available power of the switch, it can supply power to all of the PDs.

However, when the PD power requirements exceed the total available power, the switch denies power to some ports based on a process called port prioritization.

The ports on the PoE switch are assigned to one of three priority levels. These levels and descriptions are listed in Table 3. Without enough power to support all the ports set to the same priority level at one time, the switch provides power to the ports based on the port number, in ascending order. For example, when all of the ports in the switch are set to the low priority level and the power requirements are exceeded on the switch, port 1 has the highest priority level, port 2 has the next highest priority level and so forth.

Priority Level	Description
Critical	This is the highest priority level. Ports set to the Critical level are guaranteed to receive power before any of the ports assigned to the other priority levels.
High	Ports set to the High level receive power only when all the ports assigned to the Critical level are already receiving power.
Low	This is the lowest priority level. Ports set to the Low level receive power only when all the ports assigned to the Critical and High levels are already receiving power. This level is the default setting.

Configure PoE settings

PoE > Power over Ethernet

1. Log into your switch management page (see "[Access your switch management page](#)" on page 5).

2. Click on **PoE** and click on **Power over Ethernet**.

3. Review the settings for each port. Next to each port entry, click **Apply** to save the settings.

- **Power Budget** – Displays the maximum PoE power budget in watts.
- **Power Consumption** – Displays the current PoE power provided to PoE devices or PDs (Powered devices) in watts.
- **Power Management Method** – Select **Auto** for the switch to automatically manage PoE devices, or select **Manual** to manually configure settings.
- **Port** - Indicates the port with a specific PoE status and that you are configuring.
*Note: You can **Enable** the row labeled **ALL** to apply settings to all ports.*
- **Admin** - To activate or deactivate PoE on a specific port, select **Enable** or **Disable**. By default the PoE feature is disabled on all switch ports.
- **Status** - The PoE port status is given as follows:
 - **Power ON** - The port is supplying PoE power.
 - **Power OFF** - The port is not supplying PoE power.
- **Class** - The PoE class is indicated the class of the PD. N/A is displayed when the port is not supplying power.
- **Priority** - Indicates the port priority: Low, High, or Critical.
- **PowerLimit** – Indicates the power limit by class or power limit defined by the user.
- **UserDef** – After **UserDef** is selected in the **PowerLimit** cell, users can define the maximum power consumption for a specific port.
Note: The User Defined power limit ranges between 1.0 and 30.0 watts.
- **TimeRange** – Select a defined PoE **TimeRange**. N/A will be displayed if no time ranges have been created.

- **Power(mW)** - Indicates the Power in milliwatts that the port is supplying power to the PD.
- **Voltage(V)** - Indicates the Voltage in volts as measured at the port when the port is supplying power to the PD.
- **Current(mA)** - Indicates the Current in milliamps that the port is supplying to the PD.

Power Over Ethernet Settings

Power Budget:

Power Consumption: 0 W

Power Management Method:

Power Over Ethernet Table

Port	Admin	Status	Class	Priority	4-Pair State	PowerLimit	UserDef	TimeRange	Power (mW)	Voltage (V)	Current (mA)
All	<input type="text" value="Ignore"/>	-	-	<input type="text" value="Ignore"/>	<input type="text" value="Ignore"/>	<input type="text" value="Ignore"/>	<input type="text"/>	<input type="text" value="Ignore"/>	-	-	-
1	<input type="text" value="Enabled"/>	POWER OFF	N/A	<input type="text" value="Low"/>	<input type="text" value="Disabled"/>	<input type="text" value="Class 4"/>	<input type="text" value="30.0"/>	<input type="text" value="N/A"/>	0	0	0
2	<input type="text" value="Enabled"/>	POWER OFF	N/A	<input type="text" value="Low"/>	<input type="text" value="Disabled"/>	<input type="text" value="Class 4"/>	<input type="text" value="30.0"/>	<input type="text" value="N/A"/>	0	0	0
3	<input type="text" value="Enabled"/>	POWER OFF	N/A	<input type="text" value="Low"/>	<input type="text" value="Disabled"/>	<input type="text" value="Class 4"/>	<input type="text" value="30.0"/>	<input type="text" value="N/A"/>	0	0	0
4	<input type="text" value="Enabled"/>	POWER OFF	N/A	<input type="text" value="Low"/>	<input type="text" value="Disabled"/>	<input type="text" value="Class 4"/>	<input type="text" value="30.0"/>	<input type="text" value="N/A"/>	0	0	0

4. At the bottom of the left hand panel, click **Save**.

5. Select the Config you would like to save the settings to, click **Save Settings to Flash**, then click **OK**.

Note: This step saves all configuration changes to the NV-RAM to ensure that if the switch is rebooted or power cycled, the configuration changes will still be applied.

Save Settings to Flash

Config File: startup-config

Note: The switch will stop responding while saving the current configuration to flash.

Time Range

Configure PoE Time Range

PoE > Time Range

1. Log into your switch management page (see "[Access your switch management page](#)" on page 5).
2. Click on **PoE** and click on **Time Range**.
3. Review the settings for each port. Next to each port entry, click **Apply** to save the settings.
 - **Range Name** – Enter the name of the new PoE time range.
 - **Daily** – Check this box to remove weekday options, making the time range set to a daily schedule.
 - **From: Week** – Set the start day of the PoE time range.
 - **From: Time (HH:MM)** – Set the start time of the PoE time range.
 - **To: Week** – Set the end day of the PoE time range.
 - **To: Time (HH:MM)** – Set the end time of the PoE time range.
 - **End Weekday** – Check this box to set the time range to stop at the end of the defined **From: Weekday**.

Time Range						
Range Name	32 chars		<input type="checkbox"/> Daily			
From: Week	Sun	To: Week	Sun	<input type="checkbox"/> End Weekday		
From: Time (HH:MM)	00	00	To: Time (HH:MM)	00	00	
<input type="button" value="Apply"/>						
Time Range Table						
Total Entries : 0						
Range Name	Start Weekday	Start Time	End Weekday	End Time	Action	Action
< < Time range list is empty > >						

4. At the bottom of the left hand panel, click **Save**.



5. Select the Config you would like to save the settings to, click **Save Settings to Flash**, then click **OK**.

Note: This step saves all configuration changes to the NV-RAM to ensure that if the switch is rebooted or power cycled, the configuration changes will still be applied.

Save Settings to Flash		
Config File:	Config 1	<input checked="" type="checkbox"/> startup-config
Note: The switch will stop responding while saving the current configuration to flash.		
<input type="button" value="Save Settings to Flash"/>		

Security

This chapter contains information about the Port-based security features and the procedures for setting this feature.

Port Access Control

Configure Port Access Control

Security > Port Access Control

This section contains information and configuration procedures for the Port-based Access Control. Port-based Network Access Control (IEEE 802.1x) is used to control who can send traffic through and receive traffic from a switch port. With this feature, the switch does not allow an end node to send or receive traffic through a port until the user of the node logs on by entering a user name and password.

This feature can prevent an unauthorized individual from connecting a computer to a port or using an unattended workstation to access your network resources. Only those users to whom you have assigned a user name and password are able to use the switch to access the network.

This feature can be used with one of two authentication methods:

- The RADIUS authentication protocol requires that a remote RADIUS server is present on your network. The RADIUS server performs the authentication of the user name and password combinations.
- The Dial-in User (local) authentication method allows you to set up the authentication parameters internally in the switch without an external server. In this case, the user name and password combinations are entered in the associated with an optional VLAN when they are defined. Based on these entries, the authentication process is done locally by the Web Management Utility using a standard EAPOL transaction.

Note: RADIUS with Extensible Authentication Protocol (EAP) extensions is the only supported authentication server for this feature.

1. Log into your switch management page (see "[Access your switch management page](#)" on page 5).

2. Click on **Security** and click on **Port Access Control**.

3. Review the settings. Click **Apply** to save the settings.

Configure the following parameters as required:

- **NAS ID** - This parameter assigns an 802.1x identifier to the switch that applies to all ports. The NAS ID can be up to sixteen characters. Valid characters are 0 to 9, a to z, and A to Z. Spaces are allowed. Specifying an NAS ID is optional.
- **Port Access Control** - This parameter enables or disables Port Access Control. Select one of the following choices from the pulldown menu:
 - **Enable:** The Port Access Control feature is activated.
 - **Disable:** The Port Access Control feature is de-activated.
- **Authentication Method** - This parameter indicates the authentication method used by the switch. Select one of the following choices:
 - **RADIUS:** This parameter configures port security for remote authentication. After completing steps, you must configure the "RADIUS Client" section.
 - **TACACS+:** This parameter configures port security for terminal authentication. After completing steps, you must configure the "TACACS+ Settings" section.
 - **Local:** This parameter configures port security for local authentication. After completing steps, you must configure the parameters for "Dial-in User— Local Authentication" section.

Port Access Control Settings	
NAS ID:	<input type="text" value="fsNas1"/> (16 characters max)
Port Access Control:	<input type="text" value="Disabled"/>
Authentication Method:	<input type="text" value="Local"/>

4. At the bottom of the left hand panel, click **Save**.

5. Select the Config you would like to save the settings to, click **Save Settings to Flash**, then click **OK**.

Dial-in User

Create Dial-In Users (Local Authentication Method)

Security > Dial-in User

Dial-in User feature provides the local authentication server for port security when a remote (RADIUS) server is not available.

The Dial-in User (local) authentication method allows you to set up 802.1x authentication parameters internally in the Switch. In this case, the user name and password combinations are entered with an optional VLAN when they are defined. Based on these entries, the authentication process of a supplicant is done locally by the Switch Management Utility using a standard EAPOL (EAP over LAN) transaction.

1. Log into your switch management page (see "[Access your switch management page](#)" on page 5).

2. Click on **Security** and click on **Dial-In User**.

3. Review the settings.

To create a dial-in user for local authentication, use the following procedure:

- In the **User Name** field, type a name for the user.
- In the **Password** field, type a password for the user.
- In the **Dynamic VLAN** field, enter the VID of the VLAN which you will allow the user to access. If you enter 0, this field will be ignored.

Click **Add** to add the entry to the table.

Dial-In User Settings	
User Name:	<input type="text"/> (Maximum length is 20)
Password:	<input type="password"/> (20 characters max)
Dynamic VLAN:	<input type="text"/> (1-4094)

In the list, you can click **Modify** to modify an entry or click **Delete** or delete the entry. You can also click **Delete All** to delete all of the entries in the table. If the entries span multiple pages, you can navigate page number in the **Page** field and click **Go** or you can click **First**, **Previous**, **Next**, and **Last Page** to navigate the pages.

Dial-In User Table (Free Entries : 64, Total Entries : 0) Delete All			
Username	Password	Dynamic VLAN	Action
< < Dial-in user list is empty > >			
Page 0/0	First Page	Previous Page	Next Page Last Page Page <input type="text"/> GO

4. At the bottom of the left hand panel, click **Save**.

The image shows a vertical navigation menu with three items: 'Security', 'Tools', and 'Save'. The 'Save' button is highlighted with a red rectangular border.

5. Select the Config you would like to save the settings to, click **Save Settings to Flash**, then click **OK**.

Note: This step saves all configuration changes to the NV-RAM to ensure that if the switch is rebooted or power cycled, the configuration changes will still be applied.

Save Settings to Flash		
Config File:	<input type="text" value="Config 1"/>	<input checked="" type="checkbox"/> startup-config
Note: The switch will stop responding while saving the current configuration to flash.		
Save Settings to Flash		

RADIUS

Add RADIUS Servers (RADIUS Authentication Method)

Security > RADIUS

- Log into your switch management page (see "[Access your switch management page](#)" on page 5).
- Click on **Security** and click on **RADIUS**.
- Review the settings.
 - Server Priority** – Enter the RADIUS Server priority (Highest: 1, Lowest: 5).
 - Server IP Address** –Select IPv4 or IPv6 and set the RADIUS server IP address and enter the IP address of the RADIUS server you would like to add.
 - Server Port (1 - 65535)** –Set the RADIUS authentic server(s) UDP port. The default port is 1812.
 - Accounting Port (1 - 65535)** –Set the RADIUS account server(s) UDP port. The default port is 1813.
 - Shared Secret** – Enter the default authentication and encryption key for RADIUS communication between the device and the RADIUS server.

Click **Add** to add the entry to the table.

RADIUS Settings	
Server Priority:	1 (Highest :1, Lowest :5)
Server IP Address:	0 . 0 . 0 . 0 <input checked="" type="radio"/> IPv4 <input type="text"/> <input type="radio"/> IPv6
Server Port:	1812 (1-65535)
Accounting Port:	1813 (1-65535)
Shared Secret:	<input type="text"/> (32 characters limit)

In the list, you can click **Modify** to modify an entry or click **Delete** or delete the entry.

RADIUS Table					
Server Priority	Server IP Address	Server Port	Accounting Port	Shared Secret	Action
< < Radius list is empty > >					

- At the bottom of the left hand panel, click **Save**.



- Select the Config you would like to save the settings to, click **Save Settings to Flash**, then click **OK**.

Note: This step saves all configuration changes to the NV-RAM to ensure that if the switch is rebooted or power cycled, the configuration changes will still be applied.

Save Settings to Flash		
Config File:	Config 1	<input checked="" type="checkbox"/> startup-config
Note: The switch will stop responding while saving the current configuration to flash.		
Save Settings to Flash		

TACACS+

Add TACACS+ Servers (TACACS+ Authentication Method)

Security > TACACS+

Terminal Access Controller Access Control System (TACACS+) provides centralized security user access validation. The system supports up-to 5 TACACS+ servers.

TACACS+ provides a centralized user management system, while still retaining consistency with RADIUS and other authentication processes.

The TACACS+ protocol ensures network integrity through encrypted protocol exchanges between the client and TACACS+ server. The user-assigned TACACS+ parameters are applied to newly defined TACACS+ servers. If values are not defined, the system defaults are applied to the new TACACS+ servers.

1. Log into your switch management page (see "[Access your switch management page](#)" on page 5).
2. Click on **Security** and click on **TACACS+**.
3. Review the settings.
 - **Server Priority** – Enter the TACACS+ Server priority (Highest: 1, Lowest: 5).
 - **Server IP Address** – Enter the TACACS+ Server IP address.
 - **Server Port** – Enter the port number via which the TACACS+ session occurs. The default port is port 49.
 - **Timeout** – Enter the amount of time (in seconds) the device waits for an answer from the TACACS+ server before retrying the query, or switching to the next server. Possible field values are 1-255. The default value is 5.
 - **Shared Secret** – Enter the default authentication and encryption key for TACACS+ communication between the device and the TACACS+ server.

Click **Add** to add the entry to the table.

TACACS+ Settings

Server Priority:	<input type="text" value="1"/>	(Highest: 1, Lowest: 5)
Server IP Address:	<input type="text" value="0"/> . <input type="text" value="0"/> . <input type="text" value="0"/> . <input type="text" value="0"/> <input type="radio"/> IPv4	<input type="radio"/> IPv6
Server Port:	<input type="text" value="49"/>	(1-65535)
Timeout:	<input type="text" value="5"/>	(1-255 Sec)
Shared Secret:	<input type="text"/>	

In the list, you can click **Modify** to modify an entry or click **Delete** or delete the entry.

TACACS+ Table

Server Priority	Server IP Address	Server Port	Timeout	Shared Secret	Action
< < TACACS+ list is empty > >					

4. At the bottom of the left hand panel, click **Save**.
5. Select the Config you would like to save the settings to, click **Save Settings to Flash**, then click **OK**.

Note: This step saves all configuration changes to the NV-RAM to ensure that if the switch is rebooted or power cycled, the configuration changes will still be applied.

Save Settings to Flash

Config File:	<input type="text" value="Config 1"/>	<input checked="" type="checkbox"/> startup-config
--------------	---------------------------------------	--

Note: The switch will stop responding while saving the current configuration to flash.

Save Settings to Flash

Destination MAC Filter

Destination MAC Filter

Security > Destination MAC Filter

This section contains an explanation of the Destination MAC Filter feature as well a procedure for configuring it. This section includes the following information:

The Destination MAC Filter feature prevents the switch from forwarding packets to a specified device. On the Destination MAC Filter Page of the Web Management Utility software, enter the MAC address of the device that you want to filter.

After the switch receives a packet, it examines the destination MAC address of the packet. If the destination MAC address matches a MAC address set in the filter, the software prevents the switch from forwarding it and drops the packet.

You may want to block access to a device within your organization. For instance, you may not want users on the Sales group switch to have access to a server on the Accounting group switch. You can enter the MAC address of the Accounting server as a destination MAC address filter on the Sales group switch. When a packet destined for the Accounting server is received by the Sales group switch, the switch drops the packet. The Destination MAC Filter is a subset of the static MAC address.

1. Log into your switch management page (see "[Access your switch management page](#)" on page 5).
2. Click on **Security** and click on **Destination MAC Filter**.
3. Enter the **MAC Address** to add to the destination filter table. Click **Add**.

Add Destination MAC Filter

MAC Address : (e.g. 00:11:ab:cd:ef:22)

4. The MAC address will be added to the table.

In the list, you can click **Modify** to modify an entry or click **Delete** or delete the entry. You can also click **Delete All** to delete all of the entries in the table. If the entries span multiple pages, you can navigate page number in the **Page** field and click **Go** or you can click **First**, **Previous**, **Next**, and **Last Page** to navigate the pages.

Destination MAC Filter Table Delete All	
Total Entries : 0	
MAC Address	Action
< < Destination MAC Filter is empty > >	
Note: The maximum Destination MAC Filter entries is 40.	

4. At the bottom of the left hand panel, click **Save**.

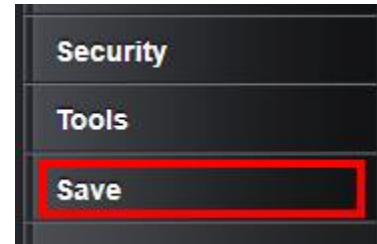

5. Select the Config you would like to save the settings to, click **Save Settings to Flash**, then click **OK**.

Note: This step saves all configuration changes to the NV-RAM to ensure that if the switch is rebooted or power cycled, the configuration changes will still be applied.

Save Settings to Flash

Config File: startup-config

Note: The switch will stop responding while saving the current configuration to flash.

Save Settings to Flash

Denial of Service

Denial of Service (DoS)

Security > Denial of Service

The switch has built-in DoS prevention features to restrict specific type of traffic associated denial of service attacks on your network. By default, all of the DoS settings are set to Allow, which allow any type of traffic to pass through the switch. Setting one of the items to Deny will set the switch to check for traffic matching the selected item and deny any traffic matching the rule. On the other hand, setting one of rules to Deny may deny a specific type of traffic that may prevent traffic essential to running your network such as devices in load balancing configuration using virtual IP addresses (Ex. If ARP MAC SA Mismatch is set to Deny, it may cause devices in load balance configuration using shared virtual IP addresses communication issues essential for network server load balancing.) For additional security, you can set these rules to Deny as necessary.

1. Log into your switch management page (see "[Access your switch management page](#)" on page 5).
2. Click on **Security** and click on **Denial of Service**.

DoS Settings	
Land Attack:	Allow ▾
Blat Attack:	Allow ▾
TCP Null Scan:	Allow ▾
TCP Xmascan:	Allow ▾
TCP SYNFIN:	Allow ▾
TCP SYN SrcPort less 1024:	Allow ▾
TCP Tiny Frag Attack:	Allow ▾

3. Next to the DoS item/rule you would like to activate, click the drop-down menu on the right hand side and select **Deny**.



4. Click **Apply** to save the settings.

Note: You can click "Reset to Default" to restore all DoS settings to Allow.



4. At the bottom of the left hand panel, click **Save**.

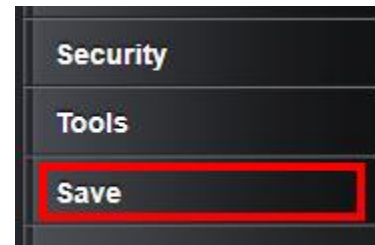

5. Select the Config you would like to save the settings to, click **Save Settings to Flash**, then click **OK**.

Note: This step saves all configuration changes to the NV-RAM to ensure that if the switch is rebooted or power cycled, the configuration changes will still be applied.

Save Settings to Flash

Config File: startup-config

Note: The switch will stop responding while saving the current configuration to flash.

Save Settings to Flash

DHCP Snooping

Settings

DHCP Snooping > Settings

Here is a summary of the rules to observe when you configure DHCP Snooping:

- A trusted port is connected to one of the following:
 - Directly to the legitimate trusted DHCP Server.
 - A network device relaying DHCP messages to and from a trusted server.
 - Another trusted source such as a switch with DHCP Snooping enabled.
 - Untrusted ports are connected to DHCP clients and to traffic that originates outside of the local area network.
- The VLANs to which the DHCP Snooping feature applies must be specified in the DHCP Snooping VLAN Setting configuration.
- Any static IP addresses on the network must be manually added to the Binding Database.

1. Log into your switch management page (see "[Access your switch management page](#)" on page 5).

2. Click on **Security**, click on **DHCP Snooping**, and click on **Settings**.

3. Review the settings. Click **Apply** to save the settings.

- **DHCP Snooping** - Select one of the following radio button choices:
 - **Enabled** - This parameter activates the DHCP Snooping feature.
 - **Disabled** - This parameter de-activates the DHCP Snooping
- **Pass Through Option 82** - Select one of the following choices from the pull-down menu:
 - **Enable** - Allows an Option 82 packet to be passed through the switch without being altered.
 - **Disable** - Blocks an Option 82 packet from passing through the switch.
- **Verify MAC Address** - Select one of the following choices from the pull-down menu:

- **Enable** - The MAC address of each ingress ARP packet is validated when compared against the Binding Table entries. Invalid ARP packets are discarded.
- **Disable** - The MAC address of each ingress ARP packet is not validated against the Binding Table. All ARP packets are forwarded through the switch without regard to the IP and MAC Address information in the packet header.
- **Backup Database** - select one of the following choices from the pull-down menu:
 - **Enable** - The Web Management Utility Software saves a backup copy of the Binding Table to flash at a specified interval (Database Update Interval) of time.
 - **Disable** - The Web Management Utility Software does not save a backup copy of the Binding Table to flash.
- **Database Update Interval** - Enter the database update interval. The range of this interval is 600 to 86400 seconds.
- **DHCP Option 82 Insertion** - select one of the following choices from the pull-down menu:
 - **Enable**: The Web Management Utility software inserts the DHCP Option 82 information into the DHCP packets.
 - **Disable**: The Web Management Utility software does not insert the DHCP Option 82 information into the DHCP packets.

DHCP Snooping Global Settings

DHCP Snooping Status:

Enabled ▾

General Settings

Pass Through Option 82:

Disabled ▾

Verify MAC Address:

Enabled ▾

Backup Database:

Disabled ▾

Database Update Interval:

1200 (600-86400)(Sec)

DHCP Option 82 Insertion:

Disabled ▾

4. At the bottom of the left hand panel, click **Save**.



5. Select the Config you would like to save the settings to, click **Save Settings to Flash**, then click **OK**.

Note: This step saves all configuration changes to the NV-RAM to ensure that if the switch is rebooted or power cycled, the configuration changes will still be applied.

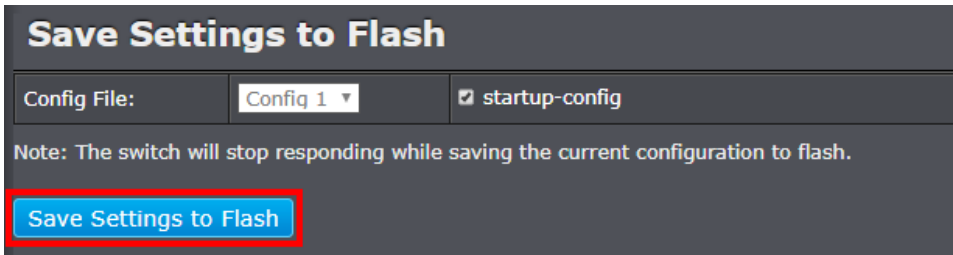

VLAN

Security > DHCP Snooping > VLAN

In this section, you can define an existing VLAN to apply DHCP snooping.

1. Log into your switch management page (see "[Access your switch management page](#)" on page 5).
2. Click on **Security**, click on **DHCP Snooping**, and click on **VLAN**.
3. In the field, enter the existing VLAN ID to apply DHCP Snooping. Then click **Add** to add the VLAN entry to the table.

In the list, you can click **Modify** to modify an entry or click **Delete** or delete the entry. You can also click **Delete All** to delete all of the entries in the table. If the entries span multiple pages, you can navigate page number in the **Page** field and click **Go** or you can click **First**, **Previous**, **Next**, and **Last Page** to navigate the pages.

4. At the bottom of the left hand panel, click **Save**.



5. Select the Config you would like to save the settings to, click **Save Settings to Flash**, then click **OK**.

Note: This step saves all configuration changes to the NV-RAM to ensure that if the switch is rebooted or power cycled, the configuration changes will still be applied.

Save Settings to Flash

Config File:

Config 1 ▼

 startup-config

Note: The switch will stop responding while saving the current configuration to flash.

Save Settings to Flash

Interfaces

Security > DHCP Snooping > Interfaces

This section allows you to set trusted port interfaces where DHCP servers can be connected allows or denies DHCP server information to be received on those ports.

1. Log into your switch management page (see "[Access your switch management page](#)" on page 5).
2. Click on **Security**, click on **DHCP Snooping**, and click on **Interfaces**.
3. Next to each port, click the **Trust** drop-down list and select one of the following options.
 - **Disable:** This parameter defines the port as untrusted for the DHCP Snooping feature.
 - **Enable:** This parameter defines the port as trusted for the DHCP Snooping feature.

Note: You can select the row labeled **ALL** to apply settings to all ports.

Trusted Interfaces Settings		
Port	Trust	Action
All	Ignore ▼	Apply
1	Enabled ▼	Apply
2	Enabled ▼	Apply

4. At the bottom of the left hand panel, click **Save**.

5. Select the Config you would like to save the settings to, click **Save Settings to Flash**, then click **OK**.

Note: This step saves all configuration changes to the NV-RAM to ensure that if the switch is rebooted or power cycled, the configuration changes will still be applied.

Binding

Security > DHCP Snooping > Binding

The Binding Database displays learned and statically assigned MAC

Address and IP Address information for each host on the local area network.

Dynamically assigned IP addresses from the DHCP server will automatically populate the table on the Binding Database page as they are assigned by the server. Statically assigned IP addresses are entered manually by entering the host's address information and clicking on the **Add** button.

1. Log into your switch management page (see "[Access your switch management page](#)" on page 5).
2. Click on **Security**, click on **DHCP Snooping**, and click on **Binding**.
3. Review the settings. Click **Add** to add the database entry to the table.
 - **MAC Address** - Enter the host's MAC Address.
 - **IP Address** - Enter the static IP Address assigned to the host.
 - **VLAN** - Enter the host's VLAN ID.
 - **Port** - Enter the port number where the host is connected.
 - **Type** - Because the IP Address being entered is static, you must select **Static**.
 - **Lease Time** - Enter the time that IP address assignment is valid. The range is 10 to 4294967295 seconds.

Binding Database Settings	
MAC Address :	<input type="text"/> : <input type="text"/> : <input type="text"/> : <input type="text"/> : <input type="text"/> : <input type="text"/> (e.g. 00:11:ab:cd:ef:22)
IP Address :	<input type="text"/> . <input type="text"/> . <input type="text"/> . <input type="text"/> <input checked="" type="radio"/> IPv4 <input type="text"/> <input type="radio"/> IPv6
VLAN :	<input type="text"/> (1-4094)
Port :	<input type="text" value="1"/>
Type :	<input type="text" value="Static"/>
Lease Time :	<input type="text"/> (10 - 4294967295)(Sec)

In the list, you can click **Modify** to modify an entry or click **Delete** or delete the entry. You can also click **Delete All** to delete all of the entries in the table. If the entries span multiple pages, you can navigate page number in the **Page** field and click **Go** or you can click **First**, **Previous**, **Next**, and **Last Page** to navigate the pages.

- **MAC Address:** This parameter shows the host's MAC Address.
- **VLAN ID:** This parameter shows the host's VLAN ID of which the DHCP client is a member.
- **IP Address:** This parameter is the IP Address assigned by the DHCP server to the DHCP client.
- **Port:** This parameter is the port number where the DHCP client is connected.
- **Type:** This parameter indicates the following:
 - **Learned-**The host IP Address is dynamically assigned by the DHCP server.
 - **Static-** The host IP Address is statically assigned. See "Static IP Addresses" on page 300 for more information.
- **Lease Time:** This parameter is the time that IP address assignment by the DHCP server is valid.

Binding Database Table							Delete All
Total Entries: 0							
MAC Address	VLAN ID	IP Address	Port	Type	Lease Time	Action	
<< The List is empty >>							
Page 0/0							
First Page		Previous Page		Next Page		Last Page	Page <input type="text"/> GO

4. At the bottom of the left hand panel, click **Save**.

5. Select the Config you would like to save the settings to, click **Save Settings to Flash**, then click **OK**.

Note: This step saves all configuration changes to the NV-RAM to ensure that if the switch is rebooted or power cycled, the configuration changes will still be applied.

Dynamic ARP Inspection

Settings

Security > Dynamic ARP Inspection > ARP Access List

1. Log into your switch management page (see "[Access your switch management page](#)" on page 5).
2. Click on **Security**, click on **Dynamic ARP Inspection**, and click on **ARP Access List**.
3. Enter a name for the List. Click **Apply** to save the settings.

4. At the bottom of the left hand panel, click **Save**.

5. Select the Config you would like to save the settings to, click **Save Settings to Flash**, then click **OK**.

Note: This step saves all configuration changes to the NV-RAM to ensure that if the switch is rebooted or power cycled, the configuration changes will still be applied.

ARP Inspection Validation

Security > Dynamic ARP Inspection > ARP Inspection Validation

1. Log into your switch management page (see "[Access your switch management page](#)" on page 5).
2. Click on **Security**, click on **Dynamic ARP Inspection**, and click on **ARP Inspection Validation**.
3. Review the settings. Click **Apply/Add** to save the settings.
 - **Src-MAC** – Select **Enable** from the drop down to enable ARP inspection validation on source MAC.
 - **Dst-MAC** – Select **Enable** from the drop down to enable ARP inspection validation on destination MAC.
 - **IP** – Select **Enable** from the drop down to enable ARP inspection validation on IP

- **ARP Access List Name** - Enter a name for the list.
- **VID List** – Enter a VID.
- **Static ACL** – Select **Yes** from the drop down menu to set a static ACL

4. At the bottom of the left hand panel, click **Save**.
5. Select the Config you would like to save the settings to, click **Save Settings to Flash**, then click **OK**.

ARP Inspection Port Settings

Security > Dynamic ARP Inspection > ARP Inspection Port Settings

1. Log into your switch management page (see "[Access your switch management page](#)" on page 5).
2. Click on **Security**, click on **Dynamic ARP Inspection**, and click on **ARP Inspection Port Settings**.
3. Select the **Port** then its **Trust State**. Click apply to save.

ARP Inspection Port Settings	
Port:	1 ▼ Trust State: Disabled ▼
<input type="button" value="Apply"/> <input type="button" value="Set to Default"/>	
Port	Trust State
1	Untrusted
2	Untrusted
3	Untrusted

4. At the bottom of the left hand panel, click **Save**.
5. Select the Config you would like to save the settings to, click **Save Settings to Flash**, then click **OK**.

Note: This step saves all configuration changes to the NV-RAM to ensure that if the switch is rebooted or power cycled, the configuration changes will still be applied.

Save Settings to Flash	
Config File:	Config 1 ▼ <input checked="" type="checkbox"/> startup-config
Note: The switch will stop responding while saving the current configuration to flash.	
<input type="button" value="Save Settings to Flash"/>	

ARP Inspection VLAN

Security > Dynamic ARP Inspection > ARP Inspection VLAN

1. Log into your switch management page (see "[Access your switch management page](#)" on page 5).
2. Click on **Security**, click on **Dynamic ARP Inspection**, and click on **ARP Inspection VLAN**.
3. Select the **VID List** then its **State**. Click apply to save.

ARP Inspection VLAN	
VID List	1,4-6 State: Enabled ▼ <input type="button" value="Apply"/>
ARP Inspection Enabled VID :	

4. At the bottom of the left hand panel, click **Save**.
5. Select the Config you would like to save the settings to, click **Save Settings to Flash**, then click **OK**.

Note: This step saves all configuration changes to the NV-RAM to ensure that if the switch is rebooted or power cycled, the configuration changes will still be applied.

Save Settings to Flash	
Config File:	Config 1 ▼ <input checked="" type="checkbox"/> startup-config
Note: The switch will stop responding while saving the current configuration to flash.	
<input type="button" value="Save Settings to Flash"/>	

ARP Inspection Statistics

Security > Dynamic ARP Inspection > ARP Inspection Statistics

1. Log into your switch management page (see "[Access your switch management page](#)" on page 5).
2. Click on **Security**, click on **Dynamic ARP Inspection**, and click on **ARP Inspection Statistics**
3. Select the **VID List** then click **Clear**.

ARP Inspection Statistics	
VID List	1,4-6 <input type="button" value="Clear by VLAN"/> <input type="button" value="Clear All"/>

4. At the bottom of the left hand panel, click **Save**.
5. Select the Config you would like to save the settings to, click **Save Settings to Flash**, then click **OK**.

Note: This step saves all configuration changes to the NV-RAM to ensure that if the switch is rebooted or power cycled, the configuration changes will still be applied.

Save Settings to Flash	
Config File:	Config 1 <input checked="" type="checkbox"/> startup-config
Note: The switch will stop responding while saving the current configuration to flash.	
<input type="button" value="Save Settings to Flash"/>	

ARP Inspection VLAN

Security > Dynamic ARP Inspection > ARP Inspection VLAN

1. Log into your switch management page (see "[Access your switch management page](#)" on page 5).
2. Click on **Security**, click on **Dynamic ARP Inspection**, and click on **ARP Inspection VLAN**
3. Select the **Log Buffer** then **Apply** to view.

ARP Inspection Log	
Log Buffer (1-1024)	32 <input type="button" value="Apply"/> <input type="button" value="Clear Log"/>

ARP Inspection VLAN			
VID List	1,4-6	State	Enabled <input type="button" value="Apply"/>
ARP Inspection Enabled VID :			

ACL

Access Control configuration allows you to control different aspects of the Ethernet traffic as it enters the switch ports and is process through the Switch. You can specify what traffic is permitted or denied to flow through the switch by setting up specific filter criteria at an ingress port. You can also manage the switching priority of Ethernet packets. All of this is done by specifying policies that define the filtering and priority behavior.

ACL Configuration Wizard

Security > ACL > ACL Configuration Wizard

The ACL Configuration Wizard page allows for simple configuration of ACL profiles and rules.

1. Log into your switch management page (see "[Access your switch management page](#)" on page 5).
2. Click on **Security**, click on **ACL**, and click on **ACL Configuration Wizard**.
3. Review the settings. Click **Apply** to save the settings.

ACL Configuration Wizard

Create an ACL rule by selecting the appropriate fields.

- **Source**- Defines the access packet origin.
 - **Any**- Indicates ACL action will be taken on packets from any source.
 - **MAC Address** – Indicates ACL action will be taken on packets from the specified MAC address.
 - **IPv4 Address**- Indicates ACL action will be taken on packets from the specified IPv4 source address.
 - **IPv6 Address**- Indicates ACL action will be taken on packets from the specified IPv6 address.
- **Destination**- Defines the access packet destination.
 - **Any**- Indicates ACL action will be taken on packets to any destination.
 - **MAC Address** – Indicates ACL action will be taken on packets to the specified MAC address.

- **IPv4 Address**- Indicates ACL action will be taken on packets to the specified IPv4 source address.
- **IPv6 Address**- Indicates ACL action will be taken on packets to the specified IPv6 address.
- **Service Type**- Defines the type of service.
 - **Any**- Indicates the ACL action will be taken on packets of all types of service.
 - **EtherType**- Specifies EtherType packet filtering.
 - **ICMP All**- Specifies ICMP packet filtering.
 - **IGMP**- Specifies IGMP packet filtering.
 - **TCP All**- Specifies TCP packet filtering.
 - **TCP Source Port**- Matches packet to corresponding TCP Source Port.
 - **TCP Destination Port**- Matches packet to corresponding TCP Destination Port.
 - **UDP All**- Specifies UDP packet filtering.
 - **UDP Source Port**- Matches packet to the corresponding UDP Source Port.
 - **UDP Destination Port**- Matches packet to the corresponding UDP Destination Port.
- **Action**- Defines the ACL action linked to the rule criteria.
 - **Permit**- This selection allows ingress packets that conform to the specified ACL criteria.
 - **Deny**- This selection drops ingress packets that conform to the specified ACL criteria.
 - **Rate Limiting**- Activates rate limiting if all ACL criteria are met.
 - **Replace DSCP**- Enter a number in the **Replaced-DSCP** field within the range of 0 to 63. This field indicates the DSCP level of interest. This field is not mandatory and you may elect to leave it blank.
- **Ports**- Defines the ports to be configured.

General ACL Rules

Source
Any

Destination
Any

Service Type
Any

Action
Permit

Ports
Ex:(1,2,4-6)

Apply

Note: ACL Wizard will create the access profile and rule automatically.
For advanced access profile/rule setting, you can manually configure it in Access Profile List.

4. At the bottom of the left hand panel, click **Save**.

5. Select the Config you would like to save the settings to, click **Save Settings to Flash**, then click **OK**.

Note: This step saves all configuration changes to the NV-RAM to ensure that if the switch is rebooted or power cycled, the configuration changes will still be applied.

Save Settings to Flash

Config File: Config 1 startup-config

Note: The switch will stop responding while saving the current configuration to flash.

Save Settings to Flash

Access Profile List

Security > ACL > Access Profile List

The Access Profile List allows users to view the active ACL profiles.

1. Log into your switch management page (see "[Access your switch management page](#)" on page 5).
2. Click on **Security**, click **ACL**, and click on **Access Profile List**.

In the list, you can click **Show Details** to view the ACL Profile details, click **Edit/New Rules** to edit or create rule details, or delete the entry. You can also click **Delete All** to delete all of the entries in the table.

ACL Profile list Table						Delete All
Profile ID	Owner Type	Profile Summary	Action	Action	Action	
1	ACL-L2	Src MAC, Dst MAC, EthType,	Show Details	Edit/New Rules	Delete	

4. At the bottom of the left hand panel, click **Save**.

5. Select the Config you would like to save the settings to, click **Save Settings to Flash**, then click **OK**.

Note: This step saves all configuration changes to the NV-RAM to ensure that if the switch is rebooted or power cycled, the configuration changes will still be applied.

Save Settings to Flash

Config File: Config 1 startup-config

Note: The switch will stop responding while saving the current configuration to flash.

Save Settings to Flash

ACL Finder

Security > ACL > ACL Finder

Allows you to view current policies assigned to each port by Index or Sequence.

1. Log into your switch management page (see "[Access your switch management page](#)" on page 5).
2. Click on **Security**, click on **ACL**, and click on **ACL Finder**.
3. The ACL Finder contains the following fields.
 - **Profile Type**- Select the Profile type for the drop-down search bar
 - **Profile ID**- Defines the Profile ID for the drop-down search bar
 - **Ports**- Defines the port number search bar.
 - **Profile ID**- Indicates the Profile ID.
 - **Access ID**- Indicates the Access ID.
 - **Profile Type**- Indicates the profile type.
 - **Summary**- Displays the ACL rule summary.
 - **Status**- Displays the ACL rule status.
 - **Action**- Includes the **Delete** button for removing ACL rules.

General ACL Rules						
ACL rule finder helps you identify any rule has been assigned to a specific port						
Profile Type	ACL-L2	Profile ID	Anv	Ports		Find
Profile ID	Access ID	Profile Type	Summary	Status	Action	
< < Acl file list is empty > >						

4. View the active policies by clicking on the **Access ID** number.

Profile Information	
Profile ID	1
Source MAC	ff:ff:ff:ff:ff:ff
Destination MAC	ff:ff:ff:ff:ff:ff
Ether Type	YES

5. Modify existing ACL rules by editing established rule details.

Rule Detail	
(Keep an input field as blank to treat the corresponding option as "don't care")	
Access ID	1 * keep blank means auto-assign
Type	Layer 2
Source MAC	ex:(00-00-00-00-00-10)
Destination MAC	ex:(00-00-00-00-FF-FF)
Ether Type	ex:(0x05DD-0xFFFF)
Ports	Ex:(1,2)
Action	Permit Ex: ratelimit(16~1000000), replace DSCP(0~63)
<input type="button" value="Previous page"/> <input type="button" value="Create/Modify"/>	

4. At the bottom of the left hand panel, click **Save**.
5. Select the Config you would like to save the settings to, click **Save Settings to Flash**, then click **OK**.

Note: This step saves all configuration changes to the NV-RAM to ensure that if the switch is rebooted or power cycled, the configuration changes will still be applied.

Save Settings to Flash	
Config File:	Config 1 <input checked="" type="checkbox"/> startup-config
Note: The switch will stop responding while saving the current configuration to flash.	
<input type="button" value="Save Settings to Flash"/>	

Tools

Firmware Upgrade

Upgrade your switch's firmware

Tools > Firmware Upgrade

TRENDnet may periodically release firmware upgrades that may add features or fix problems associated with your TRENDnet switch model and version. To check if there is a firmware upgrade available for your device, please check your TRENDnet model and version using the link. <http://www.trendnet.com/downloads/>

In addition, it is also important to verify if the latest firmware version is newer than the one your switch is currently running. To identify the firmware that is currently loaded on your switch, log in to the switch, click on the System Info section or click on Tools and click on Firmware Upgrade. The firmware used by the switch is listed as Runtime Image or Image Version. If there is a newer version available, also review the release notes to check if there were any new features you may want or if any problems were fixed that you may have been experiencing.

1. If a firmware upgrade is available, download the firmware to your computer.
2. Unzip the file to a folder on your computer.

Please note the following:

- Do not interrupt the firmware upgrade process. Do not turn off the device or press the Reset button during the upgrade.
- If you are upgrade the firmware using a laptop computer, ensure that the laptop is connected to a power source or ensure that the battery is fully charged.
- Disable sleep mode on your computer as this may interrupt the firmware upgrade process.
- Do not upgrade the firmware using a wireless connection, only using a wired network connection.
- Any interruptions during the firmware upgrade process may permanently damage your switch.

Firmware Upgrade via HTTP Settings

Tools > Firmware Upgrade

1. Log into your switch management page (see "[Access your switch management page](#)" on page 5).
2. Click on **Tools**, click on **Firmware Upgrade**.
3. Select the **Image** you would like to upgrade.

Image Select	
Next Boot Image ID:	<input checked="" type="radio"/> Image1 <input type="radio"/> Image2
Running Image ID:	Image1
<input type="button" value="Apply"/>	

Depending on your web browser, in the **via HTTP Settings** section, click **Browse** or **Choose File**.

via HTTP Settings	
Image1 Version:	2.10.011
Image2 Version:	2.10.011
Firmware File:	<input type="button" value="Choose File"/> No file chosen
Firmware Backup:	Image1 ▼
<input type="button" value="Backup"/> <input type="button" value="Upgrade"/>	

4. Navigate to the folder on your computer where the unzipped firmware file (.hex) is located and select it.
5. Click **Apply**. If prompted, click **Yes** or **OK**.

Firmware Upgrade via TFTP Settings

Tools > Firmware Upgrade

Note: Before using this method, you will require a TFTP server. There are third party TFTP server applications available for this function. If you are not familiar with the TFTP protocol, it is recommended to use the HTTP method.

1. Log into your switch management page (see "[Access your switch management page](#)" on page 5).

2. Click on **Tools**, click on **Firmware Upgrade**.

3. Make sure your TFTP server is running and note the IP address of your server and firmware file name. The TFTP server should be in the same IP subnet as the switch.

Note: It is recommended to that the firmware file (.hex) is placed in your TFTP server root directory.

5. Review the settings. Click **Apply** to start the firmware upgrade.

- **TFTP Server IP:** Enter the IP address of your TFTP server.
- **Image File Name:** Enter the firmware filename with extension. (.hex)
- **Retry Count:** Defined the number of time to attempt to pull the firmware file from the TFTP server.

6. Click **Apply** to start the firmware upgrade.

via TFTP Settings	
Image Version:	
TFTP Server IP:	<input type="text"/> . <input type="text"/> . <input type="text"/> . <input type="text"/> <input type="radio"/> IPv4 <input type="text"/> <input type="radio"/> IPv6
Image File Name:	<input type="text"/> (64 characters max.)
Firmware Backup:	<input type="text" value="Image1"/>
Retry Count:	<input type="text" value="3"/>
<input type="button" value="Backup"/> <input type="button" value="Upgrade"/>	

Config Backup Restore

Config Backup/Restore

Tools > Configuration > Backup/Restore

You may have added many customized settings to your switch and in the case that you need to reset your switch to default, all your customized settings would be lost and would require you to manually reconfigure all of your switch settings instead of simply restoring from a backed up switch configuration file. The configuration will be backed up or restored only to the currently used image.

Backup/Restore via HTTP Settings

To backup your switch configuration:

1. Log into your switch management page (see "[Access your switch management page](#)" on page 5).

2. Click on **Tools**, click on **Configuration** and click on **Backup/Restore**, under **via HTTP**.

3. Click **Backup** to save the configuration file (config.bin) to your local hard drive.

Startup-config refers to the configuration that was used to startup this switch.

Note: If prompted, choose the location on your local hard drive. If you are not prompted, the configuration file (config.bin) will be saved to your default downloads folder.

via HTTP Settings	
Select File:	<input type="button" value="Choose File"/> No file chosen
Config File:	<input type="text" value="Config 1"/> <input checked="" type="checkbox"/> startup-config
<input type="button" value="Backup"/> <input type="button" value="Restore"/>	

To restore your switch configuration:

1. Log into your switch management page (see "[Access your switch management page](#)" on page 5).

2. Click on **Tools**, click on **Configuration** and click on **Backup/Restore**, under **via HTTP**.

3. Next to **Select File**, depending on your web browser, click on **Browse** or **Choose File**.

4. A separate file navigation window should open.

5. Select the switch configuration file to restore and click **Restore**. (Default Filename: *config.bin*). If prompted, click **Yes** or **OK**.

6. Wait for the switch to restore settings.

Backup/Restore via TFTP Settings

Note: Before using this method, you will require a TFTP server. There are third party TFTP server applications available for this function. If you are not familiar with the TFTP protocol, it is recommended to use the HTTP method.

To backup your switch configuration:

1. Log into your switch management page (see "[Access your switch management page](#)" on page 5).
2. Click on **Tools**, click on **Configuration** and click on **Backup/Restore**, under **via TFTP**.
3. Make sure your TFTP server is running and note the IP address of your server and firmware file name. The TFTP server should be in the same IP subnet as the switch.
4. Review the settings. Click **Backup** to save the configuration file (config.bin) to your local hard drive on your TFTP server root directory.
 - **TFTP Server IP:** Enter the IP address of your TFTP server.

- **Config File** – Select the configuration. **Startup-config** refers to the configuration that was used to startup this switch.
- **Config File Name:** Enter the configuration file name for the backup. (Default: config.bin)

To restore your switch configuration:

1. Log into your switch management page (see "[Access your switch management page](#)" on page 5).
2. Click on **Tools**, click on **Configuration** and click on **Backup/Restore**, under **via TFTP**.
3. Make sure your TFTP server is running and note the IP address of your server and configuration file name. The TFTP server should be in the same IP subnet as the switch.

Note: It is recommended to put the configuration file (config.bin) is placed in your TFTP server root directory.
4. Review the settings. Click **Restore** to restore the switch configuration file (config.bin) from your local hard drive from your TFTP server root directory.
 - **TFTP Server IP:** Enter the IP address of your TFTP server.
 - **Config File** – Select the configuration. **Startup-config** refers to the configuration that was used to startup this switch.
 - **Config File Name:** Enter the configuration file name to restore. (Default: config.bin)
5. Wait for the switch to restore settings.

Diagnostics

Cable Diagnostics Test

Tools > Diagnostics

The switch provides a basic cable diagnostic tool in the GUI for verifying the pairs in copper cabling and estimated distance for troubleshooting purposes.

Note:

1. If the cable length displays N/A, it means that the cable length is Not Available. This may be due to the port being unable to determine the estimated cable length. If length is displayed as "N/A" it means the cable length is "Not Available". This is due to the port being unable to obtain cable length/either because its link speed is 10M or 100M, or the cables used are broken and/or of bad in quality.
2. The deviation of "Cable Fault Distance" is +/- 2 meters. No cable may be displayed in the table when the cable is less than 2 meters in length.
3. The test also measures the cable fault and identifies the fault in length according to the distance from the switch.

1. Log into your switch management page (see "[Access your switch management page](#)" on page 5).
2. Click on **Tools** and click on **Cable Diagnostic**.
3. Click on the **Port** drop-down list to select which port to run the cable diagnostic and click **Test Now** to run the test.

Cable Diagnostics Settings	
Port	1 ▼

The results will be displayed in the **Cable Diagnostic Table** below.

Cable Diagnostics Table			
Port	Test Result	Cable Fault Distance (meters)	Cable Length (meters) [in range]
10	Pair1:OK	Pair1:N/A	<50
	Pair2:OK	Pair2:N/A	
	Pair3:OK	Pair3:N/A	
	Pair4:OK	Pair4:N/A	

- **Test Results:** Displays the diagnostic results for each pair in the cable. One of the following cable status parameters is displayed:
 - **OK:** There is no problem detected with the cable.
 - **Open in Cable:** There is an open wire within the cable.
 - **Short in Cable:** Two wires are shorted together within the cable.
 - **Cross talk in Cable:** There is crosstalk detected between one pair of wires and another pair within the cable.
- **Cable Fault Distance:** This parameter specifies the distance from the switch port to the cable fault.
- **Cable Length:** This parameter specifies the length of the cable connected to the switch port.

Reboot

Reboot/Reset to factory defaults

Tools > Reboot

This section provides the procedures for rebooting or resetting the switch to factory default settings.

To reboot your switch:

You may want to reboot your switch if you are encountering difficulties with your switch and have attempted all other troubleshooting.

Note: You may want to save the settings to flash before reboot the switch under *Save Settings to Flash (menu) > Save Settings to Flash (button)*. If you have not saved your current configuration settings to flash first, the configuration changes will be lost after a reboot.

There are two methods that can be used to reboot your switch.

- **Hardware Method:** Using a paper clip, on the front panel of the switch, push and hold the **Reset** button between 1~5 seconds and release.
- **Software Method (Switch Management Page):**

1. Log into your switch management page (see "[Access your switch management page](#)" on page 5).
2. Click on **Tools** and click on **Reboot**.
3. Click the **Reboot Type** drop-down list and select **Normal** and click **Apply** to initiate a reboot. Wait for the switch complete the rebooting process.

Reboot

Reboot Type: Normal

Note: System will reboot in a few seconds after pressing the Apply button.

To reset your switch to factory defaults:

You may want to reset your switch to factory defaults if you are encountering difficulties with your switch and have attempted all other troubleshooting. Before you reset your switch to defaults, if possible, you should backup your switch configuration first, see "[Backup/Restore](#)" on page 88.

There are two methods that can be used to reset your switch to factory defaults.

- **Hardware Method:** Using a paper clip, on the front panel of the switch, push and hold the **Reset** button more than 6 seconds and release. Located on the front panel of your switch, see "[Product Hardware Features](#)" on page 2. Use this method if you are encountering difficulties with accessing your switch management page.
- **Software Method (Switch Management Page):**
 1. Log into your switch management page (see "[Access your switch management page](#)" on page 5).
 2. Click on **Tools** and click on **Reboot**.
 3. Click the **Reboot Type** drop-down list and select from one of the following options
 - **Factory Default:** Resets all switch configuration settings to factory defaults including the IP address.
 - **Factory Default Except IP:** Resets all switch configuration settings to factory defaults and leaves the current IP address configuration.

Reboot

Reboot Type: Factory Default

Note: System will reboot in a few seconds after pressing the Apply button.

The switch factory default settings are below.

Administrator User Name	admin
Administrator Password	admin
Switch IP Address	192.168.10.200
Switch Subnet Mask	255.255.255.0

Ping

Network Connectivity Test (Ping Tool)

Tools > Ping

This chapter provides the procedure to ping a node on your network from the switch. This procedure is useful in determining whether an active link exists between the switch and another network device.

The device you are pinging must be a member of the Default VLAN and within the same local area network as your switch. In other words, the port on the switch through which the node is communicating with the switch must be an untagged or tagged member of the Default VLAN.

1. Log into your switch management page (see "[Access your switch management page](#)" on page 5).
2. Click on **Tools** and click on **Ping**.
3. Review the settings. Click **Start** to start the network connectivity ping test. After the ping test is activate, you can click **Show Ping Results** to check the ping test result.
 - **Destination IP Address** - The IP address of the node you want to ping in the IPv4 or IPv6 format.
 - **Timeout Value** - Specifies the length of time, in seconds, the switch waits for a response before assuming that a ping has failed.
 - **Number of Ping Requests** - Specifies the number of ping requests you want the switch to perform.

Ping Test Settings	
Destination IP Address:	<input type="text" value="0"/> . <input type="text" value="0"/> . <input type="text" value="0"/> . <input type="text" value="0"/> <input checked="" type="radio"/> IPv4 <input type="text" value=""/> <input type="radio"/> IPv6
Timeout Value:	<input type="text" value="3"/> Sec. (1-5)
Number of Ping Requests:	<input type="text" value="10"/> Times (1-10)

Using the Web Smart Switch Management Utility

The Web Smart Management Utility allows you to do the following:

- You can easily discover all TRENDnet web smart switches on your network using the discover feature.
- You can modify the IP address settings, change the admin password, and upgrade firmware for multiple switches.

System Requirements

Operating System: Windows® 10 (32/64-bit), 8 (32/64-bit), Windows 7 (32/64-bit), Vista (32/64-bit), or XP (32/64-bit)

Installation

1. Download the latest version of the utility by navigating to <http://www.trendnet.com/support> and selecting the switch's model number within the Product Download drop-down list.
2. Extract the contents of the .zip file and run the .exe installer to install the utility.
3. At the Utility installation window, click **Next**.

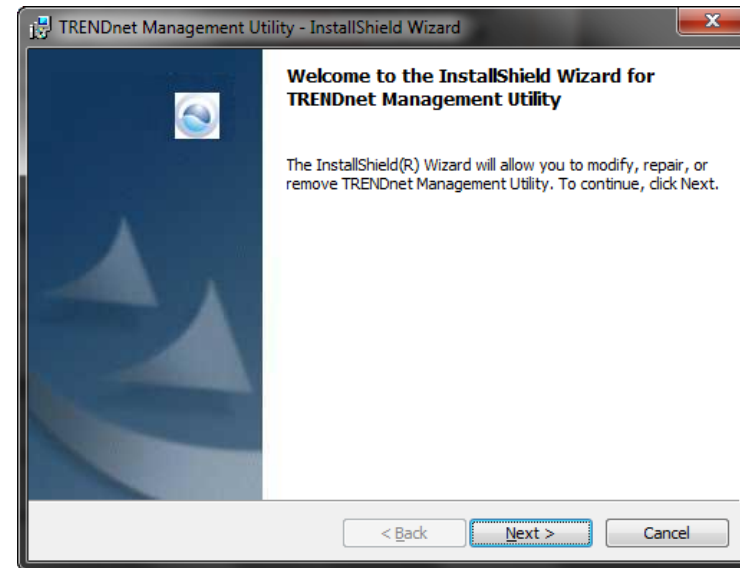

4. At the Install Location installation window, click **Next**.

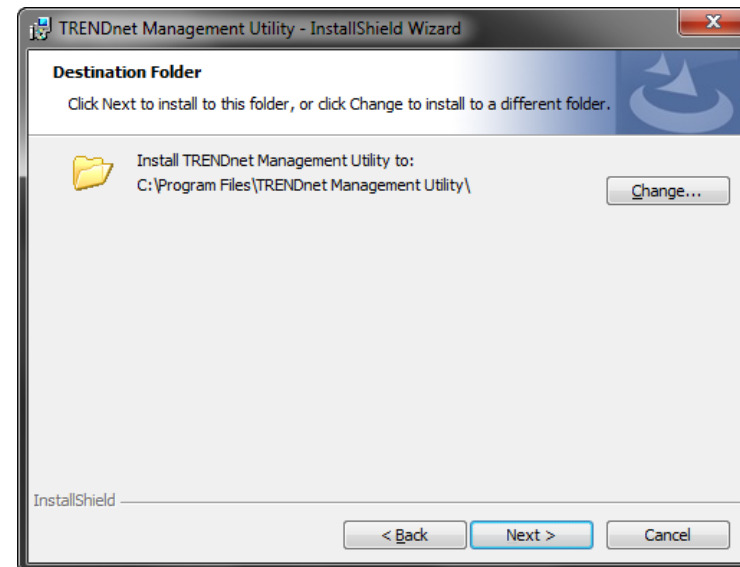

5. At the Installation, click **Install**.

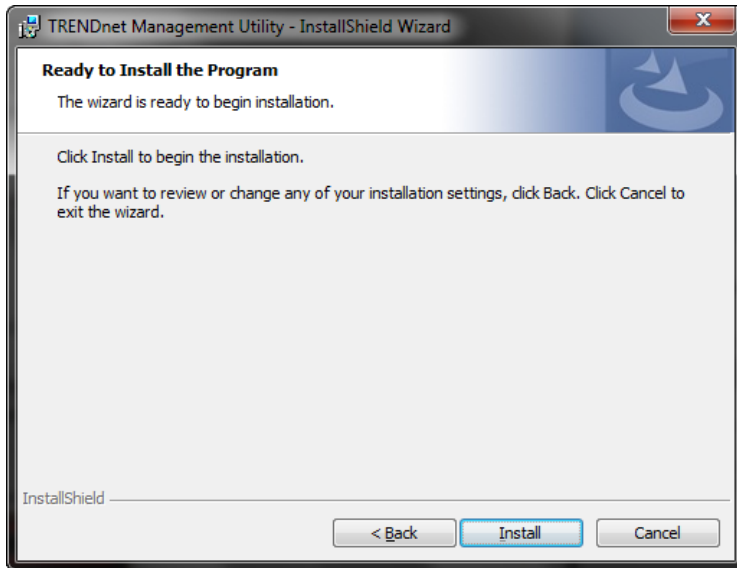

6. In the Completion window, click **Finish**.

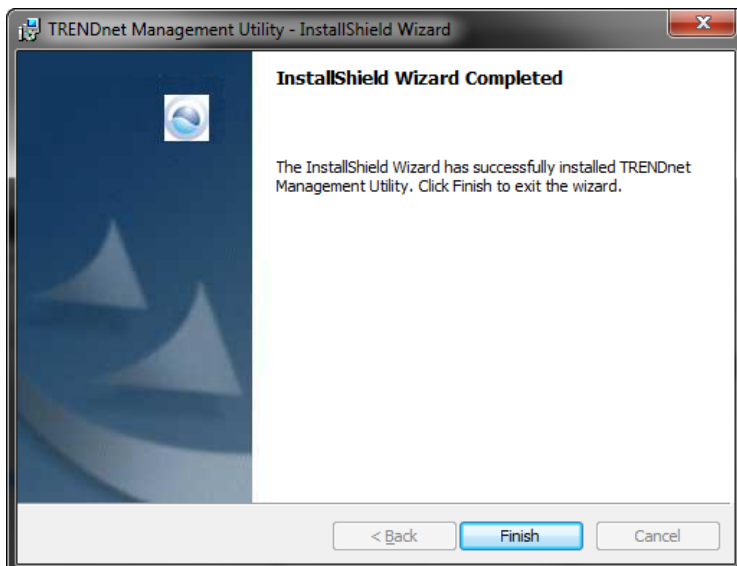

Using the Utility

Launching the Utility

Upon completing the software installation, a desktop shortcut is automatically created. Double-click the icon to start the utility or open the utility if it is already running. Closing the utility will exit the application. You can also click **Exit** at the bottom of the utility user interface to exit the application.

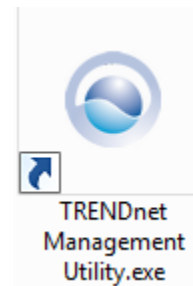

You can also launch the utility from the Start Menu programs.

Start > Programs (or All Programs) > TRENDnet Management Utility > TRENDnet Management Utility.exe

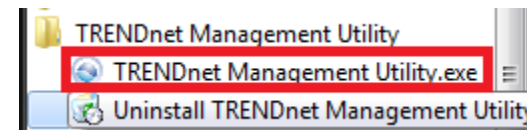

Discovery List

This is the list where you can discover all the Web management devices in your network.

By pressing the **“Discovery”** button, you can list all the Web Smart Management switches in the discovery list.

Double click or press the **“Add to monitor list”** button to select a device from the Discovery List to the Monitor List.

System word definitions in the Discovery List:

- **MAC Address:** Shows the device MAC Address.
- **IP Address:** Shows the current IP address of the device.
- **Protocol version:** Shows the version of the Utility protocol.
- **Product Name:** Shows the device product name.
- **System Name:** Shows the appointed device system name.
- **IP Mode:** Shows the DHCP status of the device.
- **Location:** Shows where the device is located.
- **Subnet Mask:** Shows the Subnet Mask set of the device.
- **Gateway:** Shows the Gateway set of the device.
- **Group Interval:**

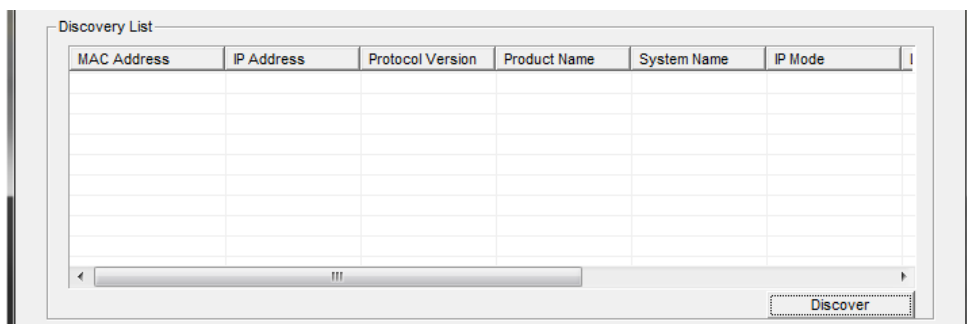

Monitor List

All the Web Smart switches in the Monitor List can be monitored; you can also receive the trap and show the status of the device.

System word definitions in the Monitor List:

- **S:** Shows the system symbol of the Web-Smart device,  represent for device system is not alive.
- **IP Address:** Shows the current IP address of the device.
- **MAC Address:** Shows the device MAC Address.
- **Protocol version:** Shows the version of the Utility protocol.
- **Product Name:** Shows the device product name.
- **System Name:** Shows the appointed device system name.
- **IP Mode:** Shows the DHCP status of the device.
- **Location:** Shows where the device is located.
- **Subnet Mask:** Shows the Subnet Mask set of the device.
- **Gateway:** Shows the Gateway set of the device.
- **Group Interval:**
- **Add Item:** To add a device to the Monitor List manually, enter the IP Address of the device that you want to monitor.
- **Delete Item:** To delete the device in the Monitor List.

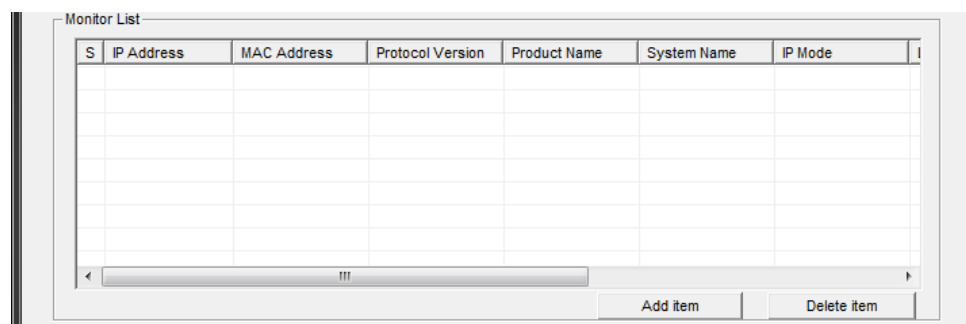

Device Setting

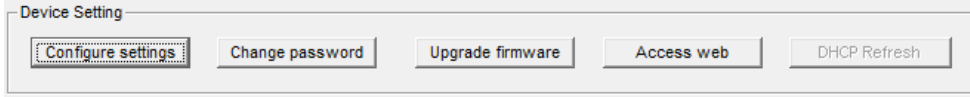

You can set the device by using the function key in the Device Setting Dialog box.

Configuration Setting: In this Configuration Setting, you can set the IP Address, Subnet Mask, Gateway, Group Interval, System name, Location and IP Mode.

Select the device in the Discovery list or Monitor List and press this button, then the Configuration Setting window will appear, after entering the data that you want to change, you must enter the password and press the "Set" to process the data change immediately. The default password of TRENDnet Web Smart Switches is "admin".

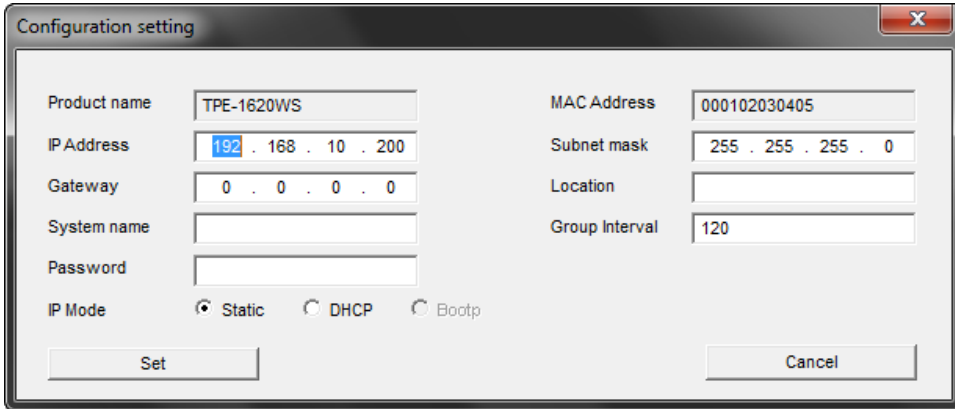

Password Change: You can use this Password Change when you need to change the password, fill in the password needed in the dialog box and press "Set" button to proceed the password change immediately.

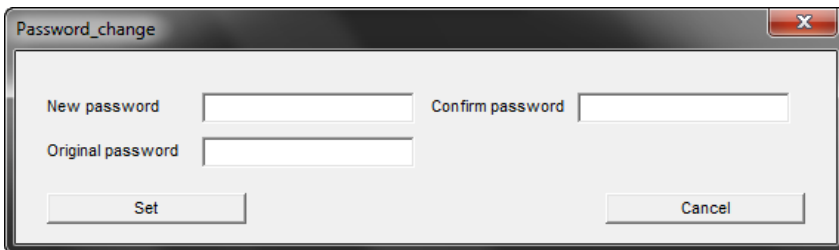

Firmware Upgrade: When the device has a new function, there will be a new firmware to update the device, use this function to update.

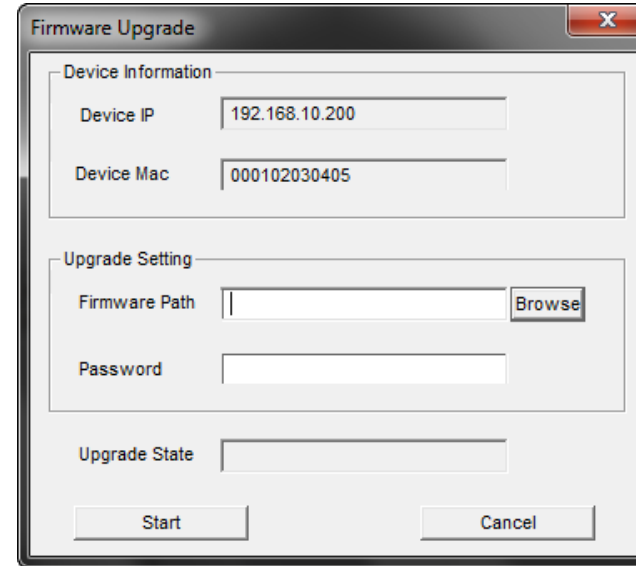

Access Web: Double click the device in the Monitor List or select a device in the Monitor List and press this "Web Access" button to access the device in Web browser.

DHCP Refresh: Press this "DHCP Refresh" button to refresh IP address of selected device form DHCP server. (Only applies if Web Smart switch IP address settings are set to DHCP).

Main Menu Options

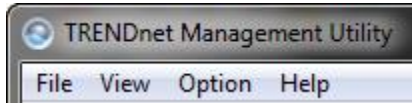

In the **"File TAB"**, there are Monitor Save, Monitor Save As, Monitor Load and Exit.

- **Monitor Save:** To record the setting of the Monitor List to the default, when you open the Web Management Utility next time, it will auto load the default recorded setting.
- **Monitor Save As:** To record the setting of the Monitor List in appointed filename and file path.
- **Monitor Load:** To manually load the setting file of the Monitor List.
- **Exit:** To exit the Web Management Utility.

In the **"View TAB"**, there are view log and clear log function, this function will help you to show trap setting.

- **View Log:** To show the event of the Web Management Utility and the device.
- **Clear Log:** to clear the log.

In the **"Option TAB"**, there are Refresh Time and Group Interval

- **Refresh Time:** *This function helps you to refresh the time of monitoring the device. Choose 15 secs, 30 secs, 1 min, 2 min and 5 min to select the time of monitoring.*
- **Group Interval:** 120~1225

In the **"Help TAB"**, there is About function, it will show out the version of the Web Management Utility.

Hardware Features and Specifications

	TPE-082WS (1.0R)	TPE-1620WS (2.0R)	TPE-1620WSF (1.0R)	TPE-2840WS (2.0R)	TPE-5028WS (1.0R)	TPE-5240WS (1.0R)	TPE-5048WS (1.0R)
Device Interface	LED Mode select button and LED indicators						
	8 x Gigabit PoE+ ports	16 x Gigabit PoE+ ports		24 x Gigabit PoE+ ports		48 x Gigabit PoE+ ports	
	2 x SFP slots	4 x Shared Gigabit ports (RJ-45/SFP)					
Data Transfer Rate	Ethernet: 10 Mbps (half duplex), 20 Mbps (full duplex)						
	Fast Ethernet: 100 Mbps (half duplex), 200 Mbps (full duplex)						
	Gigabit Ethernet: 2000 Mbps (full duplex)						
Switch fabric	20 Gbps	40 Gbps		56 Gbps		104 Gbps	
RAM buffer	4.1 Mbits					12 Mbits	
MAC Address Table	8K entries					16K entries	
Jumbo Frames	10 Kbytes						
Forwarding	14.9 Mpps (64-byte packet size)	29.8Mpps (64-byte packet size)		41.7Mpps (64-byte packet size)		77.4Mpps (64-byte packet size)	
HOL Blocking Prevention	HOL Blocking Prevention supported on all models						
Power Input	External power supply (54V DC, 1.67A)	100 - 240V AC, 50/60 Hz, internal power supply					
Power Consumption	82 Watts (max.)	226W (max.)	460W (max.)	256W (max.)	446W (max.)	479W (max.)	963W (max.)
PoE Type	802.3at: Up to 30W per port						
PoE Budget	75 Watts	185W	370W	185W	370W	740W	75 Watts
Fan Quantity	Fanless	2				3	5
Noise Level	N/A (fanless)	52 dBA (max.)				52.4 dBA (max.)	55 dBA (max.)
MTBF	862,966 hours	465,862 hours	192,382 hours	443,825 hours	277,604 hours	239,897 hours	338,601 hours

	TPE-082WS (1.0R)	TPE-1620WS (2.0R)	TPE-1620WSF (1.0R)	TPE-2840WS (2.0R)	TPE-5028WS (1.0R)	TPE-5240WS (1.0R)	TPE-5048WS (1.0R)
Operating Temperature	-5° – 50°C (23° - 122°F)						
Operating Humidity	Max. 95% non-condensing		Max. 90% non-condensing	Max. 95% non-condensing			
Dimensions	280 x 125.8 x 44 mm (11 x 5 x 1.74 in.)	440 x 250 x 44mm (17.3 x 9.8 x 1.74 in.)				440 x 430 x 44mm (17.3 x 17 x 1.74 in.)	
	Rack mountable 1U height						
Weight	0.92 kg (2 lbs.)	3.66kg (8 lbs.)	3.89kg (8.5 lbs.)	3.75kg (8.26 lbs.)	3.92kg (8.64 lbs.)	6.12kg (13.5 lbs.)	6.58kg (14.5 lbs.)
Certifications	CE						
	FCC						
	External Power Adapter (UL)	UL					
Warranty	Lifetime						
Package Contents	In addition to the switch, the package contents include the following:						
	Quick Installation Guide						
	Rack mount kit						
	Power adapter (54V DC, 1.67A)	Power cord (1.8m/6 ft.)					

Web Smart Switch Series Software Specifications

Standards	<ul style="list-style-type: none"> • IEEE 802.1d • IEEE 802.1p • IEEE 802.1Q • IEEE 802.1s • IEEE 802.1w • IEEE 802.1X 	<ul style="list-style-type: none"> • IEEE 802.1ab • IEEE 802.3 • IEEE 802.3u • IEEE 802.3x • IEEE 802.3z • IEEE 802.3ab 	<ul style="list-style-type: none"> • IEEE 802.3ad • IEEE 802.3af • IEEE 802.3at • IEEE 802.3az
Management	<ul style="list-style-type: none"> • CLI (Telnet / SSHv2) for basic administration • HTTP/HTTPS (SSL v2/3 TLS) Web based GUI • SNMP v1, v2c, v3 • RMON v1 	<ul style="list-style-type: none"> • Static Unicast MAC Address • Enable/disable 802.3az Power Saving • LLDP and LLDP-MED • Virtual Cable Diagnostics Test 	<ul style="list-style-type: none"> • IPv6: IPv6 Neighbor Discovery, IPv6 Static IP, DHCPv6, Auto configuration • Dual image and configuration • TC Root/Protect
MIB	<ul style="list-style-type: none"> • IP Forward Table MIB RFC 1354 • RMON MIB RFC 1271 • IPv4 MIB RFC 1213 • IPv6 MIB RFC 2465 • GVRP MIB IEEE 802.1Q-VLAN • LA MIB IEEE 802.3ad • LLDP MIB IEEE 802.1ab • IGMP Snooping MIB RFC 2933 • MLD Snooping MIB RFC 3019 • Private VLAN MIB IEEE 802.1Q 	<ul style="list-style-type: none"> • DHCP Snooping MIB RFC 2026 • QoS MIB RFC 4323 • SNMP MIB RFC 3415 • STP MIB RFC 4318 • PNAC MIB IEEE 802.1x • VLAN MIB IEEE 802.1q • DNS MIB RFC 1611 • ACL MIB • Bandwidth CTRL MIB • LBD MIB 	<ul style="list-style-type: none"> • Mirror MIB • IPv6 Neighbor MIB • SNTP MIB • Storm CTRL MIB • Statistics MIB • Tool MIB • Voice VLAN MIB • DoS MIB
Spanning Tree	<ul style="list-style-type: none"> • IEEE 802.1D STP (Spanning Tree protocol) 	<ul style="list-style-type: none"> • IEEE 802.1w RSTP (Rapid Spanning Tree protocol) 	<ul style="list-style-type: none"> • IEEE 802.1s MSTP (Multiple Spanning Tree protocol)
Link Aggregation	<ul style="list-style-type: none"> • Static Link Aggregation 	<ul style="list-style-type: none"> • 802.3ad Dynamic LACP 	
Quality of Service (QoS)	<ul style="list-style-type: none"> • 802.1p Class of Service (CoS) • DSCP (Differentiated Services Code Point) 	<ul style="list-style-type: none"> • Bandwidth Control per port 	<ul style="list-style-type: none"> • Queue Scheduling: Strict Priority, Weighted Round Robin (WRR)
VLAN	<ul style="list-style-type: none"> • Multiple management VLAN assignment • Asymmetric VLAN • 802.1Q Tagged VLAN 	<ul style="list-style-type: none"> • Dynamic GVRP • MAC-based VLAN • Protocol-based VLAN 	<ul style="list-style-type: none"> • Up to 256 VLAN groups, ID Range 1-4094 • Private VLAN (Protected Ports) • Voice VLAN (10 user defined OUIs)

Multicast	<ul style="list-style-type: none"> IGMP Snooping v1, v2, v3 MLD Snooping v1, v2 	<ul style="list-style-type: none"> IGMP fast leave MVR (Multicast VLAN Registration) 	<ul style="list-style-type: none"> Static Multicast Address Up to 256 multicast entries
Port Mirror	<ul style="list-style-type: none"> RX, TX, or Both 	<ul style="list-style-type: none"> Many to one 	
Access Control	<ul style="list-style-type: none"> 802.1X Port-Based Network Access Control , RADIUS, TACACS+ Local Dial In User Authentication DHCP Snooping (per VLAN) Loopback Detection 	<ul style="list-style-type: none"> Duplicated Address Detection Trusted Host Denial of Service (DoS) IP MAC port binding 	<ul style="list-style-type: none"> Dynamic ARP inspection Block unknown multicast
ACL IPv4 L2-L4 & IPv6	<ul style="list-style-type: none"> MAC Address VLAN ID Ether Type (IPv4 only) 	<ul style="list-style-type: none"> IP Protocol 0-255 TCP/UDP Port 1-65535 802.1p 	<ul style="list-style-type: none"> DSCP (IPv4 only) IPv6 Address (IPv6 only)
Layer 3 Features	<ul style="list-style-type: none"> IPv4 / IPv6 static routing IP interfaces: Up to 6 	<ul style="list-style-type: none"> Routing table entries: Up to 32 (IPv4 / IPv6) ARP table (up to 128 entries) 	<ul style="list-style-type: none"> Inter-VLAN routing
Compatibility	Optional Software Utility: Windows® 10, 8.1, 8, 7, Vista, XP, Windows® 2003/2008 Server		

Quick Installation Guide Troubleshooting

Q: I typed <http://192.168.10.200> in my Internet Browser Address Bar, but an error message says "The page cannot be displayed." How can I access the switch management page?

Answer:

1. Check your hardware settings again. See "[Switch Installation](#)" on page 8.
2. Make sure the Power and port Link/Activity and WLAN lights are lit.
3. Make sure your network adapter TCP/IP settings are set to Use the following IP address or Static IP (see the steps below).
4. Make sure your computer is connected to one of the Ethernet switch ports.
5. Since the switch default IP address is 192.168.10.200, make sure there are no other network devices assigned an IP address of 192.168.10.200

Windows 7/8.1/10

- a. Go into the **Control Panel**, click **Network and Sharing Center**.
- b. Click **Change Adapter Settings**, right-click the **Local Area Connection** icon.
- c. Then click **Properties** and click **Internet Protocol Version 4 (TCP/IPv4)**.
- d. Then click **Use the following IP address**, and make sure to assign your network adapter an IP address in the subnet of 192.168.10.x. Click **OK**

Windows Vista

- a. Go into the **Control Panel**, click **Network and Internet**.
- b. Click **Manage Network Connections**, right-click the **Local Area Connection** icon and click **Properties**.
- c. Click **Internet Protocol Version (TCP/IPv4)** and then click **Properties**.
- d. Then click **Use the following IP address**, and make sure to assign your network adapter an IP address in the subnet of 192.168.10.x. Click **OK**

Windows XP/2000

- a. Go into the **Control Panel**, double-click the **Network Connections** icon
- b. Right-click the **Local Area Connection** icon and the click **Properties**.
- c. Click **Internet Protocol (TCP/IP)** and click **Properties**.
- d. Then click **Use the following IP address**, and make sure to assign your network adapter an IP address in the subnet of 192.168.10.x. Click **OK**

Note: If you are experiencing difficulties, please contact your computer or operating system manufacturer for assistance.

Q: If my switch IP address is different than my network's subnet, what should I do?

Answer:

You should still configure the switch first. After all the settings are applied, go to the switch configuration page, click on System, click IPv4 Setup and change the IP address of the switch to be within your network's IP subnet. Click Apply, then click OK. Then click Save Settings to Flash (menu) and click Save Settings to Flash to save the IP settings to the NV-RAM.

Q: I changed the IP address of the switch, but I forgot it. How do I reset my switch?

Answer:

Using a paper clip, push and hold the reset button on the rear of the switch and release after 6~10 seconds.

The default IP address of the switch is 192.168.10.200. The default user name and password is "admin".

Appendix

How to find your IP address?

Note: Please note that although the following procedures provided to follow for your operating system on configuring your network settings can be used as general guidelines, however, it is strongly recommended that you consult your computer or operating system manufacturer directly for assistance on the proper procedure for configuring network settings.

Command Prompt Method

Windows 2000/XP/Vista/7/8.1/10

1. On your keyboard, press **Windows Logo+R** keys simultaneously to bring up the Run dialog box.
2. In the dialog box, type **cmd** to bring up the command prompt.
3. In the command prompt, type **ipconfig /all** to display your IP address settings.

MAC OS X

1. Navigate to your **Applications** folder and open **Utilities**.
2. Double-click on **Terminal** to launch the command prompt.
3. In the command prompt, type **ipconfig getifaddr <en0 or en1>** to display the wired or wireless IP address settings.

Note: **en0** is typically the wired Ethernet and **en1** is typically the wireless Airport interface.

Graphical Method

MAC OS 10.6/10.5

1. From the Apple menu, select **System Preferences**.
2. In System Preferences, from the **View** menu, select **Network**.
3. In the Network preference window, click a network port (e.g., Ethernet, AirPort, modem). If you are connected, you'll see your IP address settings under "Status:"

MAC OS 10.4

1. From the Apple menu, select **Location**, and then **Network Preferences**.
2. In the Network Preference window, next to "Show:", select **Network Status**. You'll see your network status and your IP address settings displayed.

Note: If you are experiencing difficulties, please contact your computer or operating system manufacturer for assistance.

How to configure your network settings to use a static IP address?

Note: Please note that although the following procedures provided to follow for your operating system on configuring your network settings can be used as general guidelines, however, it is strongly recommended that you consult your computer or operating system manufacturer directly for assistance on the proper procedure for configuring network settings.

Windows 7/8.1/10

- a. Go into the **Control Panel**, click **Network and Sharing Center**.
- b. Click **Change Adapter Settings**, right-click the **Local Area Connection** icon.
- c. Then click **Properties** and click **Internet Protocol Version 4 (TCP/IPv4)**.
- d. Then click **Use the following IP address**, and assign your network adapter a static IP address. Click **OK**

Windows Vista

- a. Go into the **Control Panel**, click **Network and Internet**.
- b. Click **Manage Network Connections**, right-click the **Local Area Connection** icon and click **Properties**.
- c. Click **Internet Protocol Version (TCP/IPv4)** and then click **Properties**.
- d. Then click **Use the following IP address**, and assign your network adapter a static IP address. Click **OK**

Windows XP/2000

- a. Go into the **Control Panel**, double-click the **Network Connections** icon
- b. Right-click the **Local Area Connection** icon and the click **Properties**.
- c. Click **Internet Protocol (TCP/IP)** and click **Properties**.
- d. Then click **Use the following IP address**, and assign your network adapter a static IP address. Click **OK**

MAC OS 10.4/10.5/10.6

- a. From the **Apple**, drop-down list, select **System Preferences**.
- b. Click the **Network** icon.
- c. From the **Location** drop-down list, select **Automatic**.
- d. Select and view your Ethernet connection.

In MAC OS 10.4, from the **Show** drop-down list, select **Built-in Ethernet** and select the **TCP/IP** tab.

In MAC OS 10.5/10.6, in the left column, select **Ethernet**.

e. Configure TCP/IP to use a static IP.

In MAC 10.4, from the **Configure IPv4**, drop-down list, select **Manually** and assign your network adapter a static IP address. Then click the **Apply Now** button.

In MAC 10.5/10.6, from the **Configure** drop-down list, select **Manually** and assign your network adapter a static IP address. Then click the **Apply** button.

f. Restart your computer.

Note: If you are experiencing difficulties, please contact your computer or operating system manufacturer for assistance.

How to find your MAC address?

In Windows 2000/XP/Vista/7/8.1/10,

Your computer MAC addresses are also displayed in this window, however, you can type **getmac -v** to display the MAC addresses only.

In MAC OS 10.4,

1. **Apple Menu > System Preferences > Network**
2. From the **Show** menu, select **Built-in Ethernet**.
3. On the **Ethernet** tab, the **Ethernet ID** is your MAC Address.

In MAC OS 10.5/10.6,

1. **Apple Menu > System Preferences > Network**
2. Select **Ethernet** from the list on the left.
3. Click the **Advanced** button.
3. On the **Ethernet** tab, the **Ethernet ID** is your MAC Address.

How do I use the ping tool to check for network device connectivity?

Windows 2000/XP/Vista/7/8.1/10

1. On your keyboard, press **Windows Logo+R** keys simultaneously to bring up the Run dialog box.
2. In the dialog box, type **cmd** to bring up the command prompt.
3. In the command prompt, type **ping <ip_address>** with the **<ip_address>** being the IP address you want ping and check for connectivity.

Example: Usage of ping command and successful replies from device.

```
C:\Users>ping 192.168.10.100
```

```
Pinging 192.168.10.100 with 32 bytes of data:
```

```
Reply from 192.168.10.100: bytes=32 time<1ms TTL=64
```

```
Reply from 192.168.10.100: bytes=32 time<1ms TTL=64
```

```
Reply from 192.168.10.100: bytes=32 time<1ms TTL=64
```

```
Reply from 192.168.10.100: bytes=32 time<1ms TTL=64
```

```
Ping statistics for 192.168.10.100:
```

```
    Packets: Sent = 4, Received = 4, Lost = 0 (0% loss),
```

```
Approximate round trip times in milli-seconds:
```

```
    Minimum = 0ms, Maximum = 0ms, Average = 0ms
```

MAC OS X

1. Navigate to your **Applications** folder and open **Utilities**.
2. Double-click on **Terminal** to launch the command prompt.
3. In the command prompt, type **ping -c <#> <ip_address>** with the **<#>** ping being the number of time you want to ping and the **<ip_address>** being the IP address you want ping and check for connectivity.

Example: ping -c 4 192.168.10.100

Federal Communication Commission Interference Statement

This device complies with Part 15 of FCC Rules. Operation is subject to the following two conditions: (1) this device may not cause harmful interference, and (2) this device must accept any interference received; including interference that may cause undesired operation.

This equipment has been tested and found to comply with the limits for a Class A digital device, pursuant to Part 15 of the FCC Rules. These limits are designed to provide reasonable protection against harmful interference when the equipment is operated in a commercial environment. This equipment generates, uses, and can radiate radio frequency energy, and if it is not installed and used in accordance with the instruction manual, it may cause harmful interference to radio communications. Operation of this equipment in a residential area is likely to cause harmful interference, in which case the user will be required to correct the interference at his own expense.

WARNING: Any changes or modifications to this product not expressly approved by the party responsible for compliance could void the user's authority to operate the equipment.



IMPORTANT NOTE:

Radiation Exposure Statement:

This equipment complies with FCC radiation exposure limits set forth for an uncontrolled environment. This equipment should be installed and operated with minimum distance 20cm between the radiator & your body.

This transmitter must not be co-located or operating in conjunction with any other antenna or transmitter.

Country Code selection feature to be disabled for products marketed to the US/CANADA

RoHS

This product is RoHS compliant.



Europe – EU Declaration of Conformity

This device complies with the essential requirements of the R&TTE Directive 2004/108/EC and 2006/95/EC.

- EN 60950-1:2006 + A11:2009 + A1:2010 + A12:2011 + A2:2013
- EN 55032:2015 (CISPR32:2015) (Class A)
- EN 61000-3-2:2014
- EN 61000-3-3: 2013
- EN55024:2010 + A1:2015
- AS/NZS CISPR 32:2015



Directives:

EMC Directive 2014/30/EU
 RoHS Directive 2011/65/EU
 WEEE Directive 2012/19/EU
 REACH Regulation (EC) No. 1907/2006
 Low Voltage Directive 2014/35/EU

CE Mark Warning

This is a Class A product. In a domestic environment, this product may cause radio interference, in which case the user may be required to take adequate measures.

Limited Warranty

TRENDnet warrants only to the original purchaser of this product from a TRENDnet authorized reseller or distributor that this product will be free from defects in material and workmanship under normal use and service. This limited warranty is non-transferable and does not apply to any purchaser who bought the product from a reseller or distributor not authorized by TRENDnet, including but not limited to purchases from Internet auction sites.

Limited Warranty

TRENDnet warrants its products against defects in material and workmanship, under normal use and service. Specific warranty periods are listed on each of the respective product pages on the TRENDnet website.

- AC/DC Power Adapter, Cooling Fan, and Power Supply carry a one-year warranty.

Limited Lifetime Warranty

TRENDnet offers a limited lifetime warranty for all of its metal-enclosed network switches that have been purchased in the United States/Canada on or after 1/1/2015.

- Cooling fan and internal power supply carry a one-year warranty

To obtain an RMA, the ORIGINAL PURCHASER must show Proof of Purchase and return the unit to the address provided. The customer is responsible for any shipping-related costs that may occur. Replacement goods will be shipped back to the customer at TRENDnet's expense.

Upon receiving the RMA unit, TRENDnet may repair the unit using refurbished parts. In the event that the RMA unit needs to be replaced, TRENDnet may replace it with a refurbished product of the same or comparable model.

In the event that, after evaluation, TRENDnet cannot replace the defective product or there is no comparable model available, we will refund the depreciated value of the product.

If a product does not operate as warranted during the applicable warranty period, TRENDnet shall reserve the right, at its expense, to repair or replace the defective product or part and deliver an equivalent product or part to the customer. The repair/replacement unit's warranty continues from the original date of purchase. All products that are replaced become the property of TRENDnet. Replacement products may be new or reconditioned. TRENDnet does not issue refunds or credit. Please contact the point-of-purchase for their return policies.

TRENDnet shall not be responsible for any software, firmware, information, or memory data of customer contained in, stored on, or integrated with any products returned to TRENDnet pursuant to any warranty.

There are no user serviceable parts inside the product. Do not remove or attempt to service the product by any unauthorized service center. This warranty is voided if (i) the product has been modified or repaired by any unauthorized service center, (ii) the product was subject to accident, abuse, or improper use, or (iii) the product was subject to conditions more severe than those specified in the manual.

Warranty service may be obtained by contacting TRENDnet within the applicable warranty period and providing a copy of the dated proof of the purchase. Upon proper submission of required documentation, a Return Material Authorization (RMA) number will be issued. An RMA number is required in order to initiate warranty service support for all TRENDnet products. Products that are sent to TRENDnet for RMA service must have the RMA number marked on the outside of return packages and sent to TRENDnet prepaid, insured and packaged appropriately for safe shipment. International customers

shipping from outside of the USA and Canada are responsible for any return shipping and/or customs charges, including but not limited to, duty, tax, and other fees.

Refurbished product: Refurbished products carry a 90-day warranty after date of purchase. Please retain the dated sales receipt with purchase price clearly visible as evidence of the original purchaser's date of purchase. Replacement products may be refurbished or contain refurbished materials. If TRENDnet, by its sole determination, is unable to replace the defective product, we will offer a refund for the depreciated value of the product.

WARRANTIES EXCLUSIVE: IF THE TRENDNET PRODUCT DOES NOT OPERATE AS WARRANTED ABOVE, THE CUSTOMER'S SOLE REMEDY SHALL BE, AT TRENDNET'S OPTION, REPAIR OR REPLACE. THE FOREGOING WARRANTIES AND REMEDIES ARE EXCLUSIVE AND ARE IN LIEU OF ALL OTHER WARRANTIES, EXPRESSED OR IMPLIED, EITHER IN FACT OR BY OPERATION OF LAW, STATUTORY OR OTHERWISE, INCLUDING WARRANTIES OF MERCHANTABILITY AND FITNESS FOR A PARTICULAR PURPOSE. TRENDNET NEITHER ASSUMES NOR AUTHORIZES ANY OTHER PERSON TO ASSUME FOR IT ANY OTHER LIABILITY IN CONNECTION WITH THE SALE, INSTALLATION, MAINTENANCE, OR USE OF TRENDNET'S PRODUCTS.

TRENDNET SHALL NOT BE LIABLE UNDER THIS WARRANTY IF ITS TESTING AND EXAMINATION DISCLOSE THAT THE ALLEGED DEFECT IN THE PRODUCT DOES NOT EXIST OR WAS CAUSED BY CUSTOMER'S OR ANY THIRD PERSON'S MISUSE, NEGLIGENCE, IMPROPER INSTALLATION OR TESTING, UNAUTHORIZED ATTEMPTS TO REPAIR OR MODIFY, OR ANY OTHER CAUSE BEYOND THE RANGE OF THE INTENDED USE, OR BY ACCIDENT, FIRE, LIGHTNING, OR OTHER HAZARD.

LIMITATION OF LIABILITY: TO THE FULL EXTENT ALLOWED BY LAW, TRENDNET ALSO EXCLUDES FOR ITSELF AND ITS SUPPLIERS ANY LIABILITY, WHETHER BASED IN

CONTRACT OR TORT (INCLUDING NEGLIGENCE), FOR INCIDENTAL, CONSEQUENTIAL, INDIRECT, SPECIAL, OR PUNITIVE DAMAGES OF ANY KIND, OR FOR LOSS OF REVENUE OR PROFITS, LOSS OF BUSINESS, LOSS OF INFORMATION OR DATE, OR OTHER FINANCIAL LOSS ARISING OUT OF OR IN CONNECTION WITH THE SALE, INSTALLATION, MAINTENANCE, USE, PERFORMANCE, FAILURE, OR INTERRUPTION OF THE POSSIBILITY OF SUCH DAMAGES, AND LIMITS ITS LIABILITY TO REPAIR, REPLACEMENT, OR REFUND OF THE PURCHASE PRICE PAID, AT TRENDNET'S OPTION. THIS DISCLAIMER OF LIABILITY FOR DAMAGES WILL NOT BE AFFECTED IF ANY REMEDY PROVIDED HEREIN SHALL FAIL OF ITS ESSENTIAL PURPOSE.

Governing Law: This Limited Warranty shall be governed by the laws of the state of California.

Some TRENDnet products include software code written by third party developers. These codes are subject to the GNU General Public License ("GPL") or GNU Lesser General Public License ("LGPL").

Visit <http://www.trendnet.com/gpl> or the support section on <http://www.trendnet.com> and search for the desired TRENDnet product to access to the GPL Code or LGPL Code. These codes are distributed WITHOUT WARRANTY and are subject to the copyrights of the developers. TRENDnet does not provide technical support for these codes. Please visit <http://www.gnu.org/licenses/gpl.txt> or <http://www.gnu.org/licenses/lgpl.txt> for specific terms of each license.

PWP07172015v3

2018/04/15



Please ensure your switch's firmware version is V2.10.010 or newer for Layer 2+ management features. See the Firmware Upgrade section in this document for additional information regarding the firmware upgrade procedure.

Product Warranty Registration

Please take a moment to register your product online.
Go to TRENDnet's website at <http://www.trendnet.com/register>

TRENDnet
20675 Manhattan Place
Torrance, CA 90501. USA