

TRENDnet®



Quick Installation Guide

Web Smart Switch Series

Table of Contents

1 Español

1. Antes de comenzar
2. Referencia rápida
3. Instalación y configuración del Hardware

1. Antes de comenzar

Contenidos del paquete

- Guía de instalación rápida
- Cable corriente (1.8 m / 6 pies)
- Kit para montaje al estante

Requerimientos Minimos

- Un computador con un puerto Ethernet y un navegador Web
- Cable de red

Equipo Opcional

- Rack estándar de 19"
- Módulo SFP (Ej. TE100-MGBFX, TEG-MGBSX, TEG-MGBS10, TEG-MGBS40, TEG-MGBS80, TEG-MGBS10D3, TEG-MGBS10D5, TEG-MGBS40D3, TEG-MGBS40D5)

2. Referencia rápida

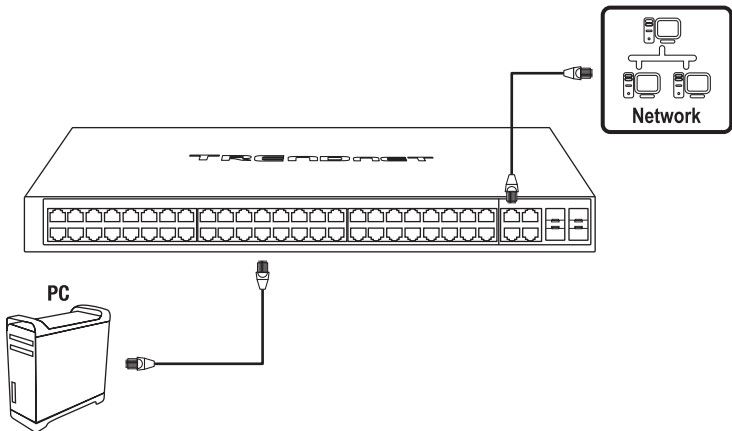

Nota: El modelo de switch puede ser diferente al que se muestra en el siguiente ejemplo.

3. Instalación y configuración del Hardware

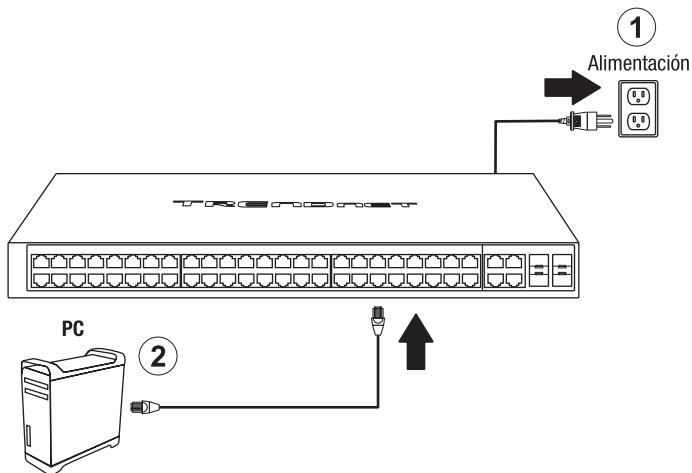

3. Asigne una dirección IP estática al adaptador de red de su computador en la máscara de subred de 192.168.10.x (e.j. 192.168.10.25) y máscara de subred de 255.255.255.0.
4. Abra su navegador Web, escriba la dirección IP del switch en la barra de dirección, y luego pulse **Enter** (Intro). La dirección IP por defecto es 192.168.10.200.

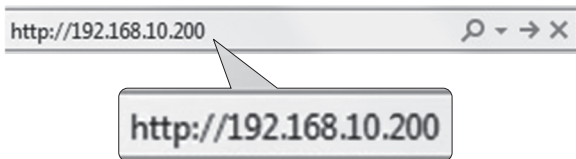

5. Introduzca el **User name** (Nombre de Usuario) y **Password** (contraseña), y después pulse **LOGIN**. Por defecto:

User Nam (Nombre de Usuario): **admin**

Password (Contraseña): **admin**

Nota: El nombre de usuario y la contraseña distinguen entre mayúsculas y minúsculas.

The screenshot shows a login form with two input fields. The first field is labeled 'User Name:' and contains the text 'admin'. The second field is labeled 'Password:' and contains six dots. Below the fields are two buttons: a smaller 'LOGIN' button and a larger, more prominent 'LOGIN' button. Callout boxes point to the 'admin' text in both fields and the larger 'LOGIN' button.

6. Haga clic en **System** (Sistema) y después en **IPv4 Setup** (Configuración IPv4).

7. Configure el switch para que coincida con los requisitos de su red. Haga clic en **Apply** (Aplicar).

The screenshot shows two configuration pages side-by-side. The left page is titled 'Switch Info' and has a 'System' menu item selected. The right page is titled 'IPv4 Setup' and shows configuration fields: 'System MAC Address' (00-01-02:03:04:05), 'System IP Address' (192.168.10.200), 'System Subnet Mask' (255.255.255.0), 'System Default Gateway' (0.0.0.0), and 'System IP Mode' (Static). An 'Apply' button is at the bottom of the IPv4 Setup page. Callout boxes point to 'System' and 'IPv4 Setup' in the left menu, and the 'Apply' button.

8. Haga clic en **OK**.

The screenshot shows a dialog box with a 'WARNING' title and a warning icon. The text inside reads: 'The management session will be disconnected. Use new IP address to connect to device.' At the bottom are two buttons: 'OK' and 'Cancel'. A callout box points to the 'OK' button.

9. En el panel de la izquierda, haga clic en **Tools** (herramientas), después en **Configuration** (configuración) y por último en **Save** (guardar).

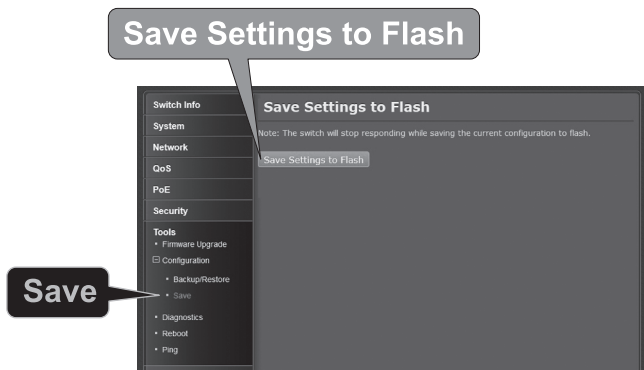

10. Haga clic en **OK**.

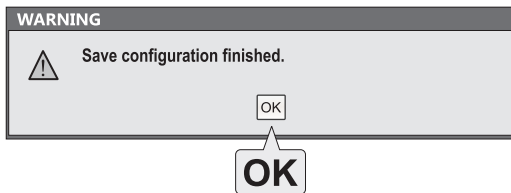

Nota:

1. Si desea encontrar con facilidad todos los conmutadores de gestión Web en la red asigne una dirección IP, cambie la contraseña, actualice la nueva versión del firmware, y después instale la herramienta de gestión Web. Siga los siguientes pasos.
2. Para descargar la última versión de la guía del usuario, visite: <http://www.trendnet.com/support> y seleccione el **Switch Model**, en la lista desplegable Product Download (descarga de productos).

UL Warning

- 1) Elevated Operating Ambient Temperature - If installed in a closed or multi-unit rack assembly, the operating ambient temperature of the rack environment may be greater than room ambient. Therefore, consideration should be given to installing the equipment in an environment compatible with the manufacturer's maximum rated ambient temperature (Tmra).
- 2) Reduced Air Flow - Installation of the equipment in a rack should be such that the amount of air flow required for safe operation of the equipment is not compromised.
- 3) Mechanical Loading - Mounting of the equipment in the rack should be such that a hazardous condition is not achieved due to uneven mechanical loading.
- 4) Circuit Overloading - Consideration should be given to the connection of the equipment to the supply circuit and the effect that overloading of circuits might have on over current protection and supply wiring. Appropriate consideration of equipment nameplate ratings should be used when addressing this concern.
- 5) Reliable Earthing - Reliable earthing of rack-mounted equipment should be maintained. Particular attention should be given to supply connections other than direct connections to the branch circuit (e.g., use of power strips).

Rack Installation

The Switch can be mounted in an EIA standard, 19-inch rack, which can be placed in a wiring closet with other equipment. To install, attach the mounting brackets on the switch's front panel (one on each side) and secure them with the screws provided.

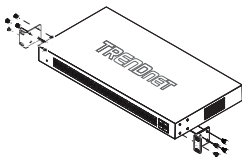

Attaching the mounting brackets to the Switch

Use the screws provided with the equipment rack to mount the Switch on the rack.

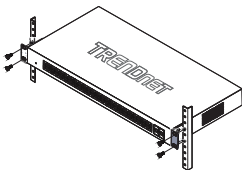

Installing the Switch in an equipment rack

TRENDNET[®]

Certifications

This device complies with Part 15 of the FCC Rules.

Operation is subject to the following two conditions:

- (1) This device may not cause harmful interference.
- (2) This device must accept any interference received.

Including interference that may cause undesired operation.



Waste electrical and electronic products must not be disposed of with household waste. Please recycle where facilities exist. Check with your Local Authority or Retailer for recycling advice.

Fiber product warning note:

If the Optical Transceiver doesn't ship with the unit, the user manual shall have the description as below or equivalent:

"This product is intended to be used with a UL Listed Optical Transceiver product, Rated DC3.3V, Laser Class I."

Laser warning note:

This product is intended to be used with a UL Listed Optical Transceiver product, Rated DC3.3V, Laser Class I.

Technical Support

If you have any questions regarding the product installation, please contact our Technical Support.

Toll free US/Canada: **1-855-373-4741**

Regional phone numbers available at www.trendnet.com/support

TRENDnet

20675 Manhattan Place
Torrance, CA 90501
USA

Applies to PoE Products Only: This product is to be connected only to PoE networks without routing to the outside plant.

Note

The Manufacturer is not responsible for any radio or TV interference caused by unauthorized modifications to this equipment. Such modifications could void the user's authority to operate the equipment.

Advertencia

En todos nuestros equipos se mencionan claramente las características del adaptador de alimentación necesario para su funcionamiento. El uso de un adaptador distinto al mencionado puede producir daños físicos y/o daños al equipo conectado. El adaptador de alimentación debe operar con voltaje y frecuencia de la energía eléctrica domiciliar existente en el país o zona de instalación.

Product Warranty Registration

Please take a moment to register your product online. Go to TRENDnet's website at: www.trendnet.com/register